



bticino

**EKİM 2024
FİYAT LİSTESİ**

Bir grup markasıdır

legrand®

LIVING now®



Zamansız tasarım, akıllı çözümler

Living ailesinin en yeni üyesi olan Living Now, zamansız tasarımının yanı sıra sunduğu akıllı çözümler ile sektörde bir devrime öncülük ediyor. Evinizi, e-mail hesabınızı ya da banka hesaplarınızı kontrol eder gibi kontrol edin. Tüm bu kontroller tamamen güvenli ve kolay kullanımı ile parmağınızın ucunda.



Geleneksel
kontrol



Akıllı telefonla
kontrol



Sesli kontrol

livingnow.bticino.com.tr

bticino

TÜM İHTİYAÇLAR İÇİN DOĞRU ÇÖZÜM

AKILLI ELEKTRİK SİSTEMİ

Living Now ^{WITH} Netatmo



HOME + CONTROL

GELENEKSEL KURULUM

Geleneksel bir elektrik tesisatı kurun ve akıllı işlevleri ekleyin. HOME+CONTROL uygulamasını kullanarak kontrol edin.

FONKSİYONLAR

- Aydınlatma
- Perde/panjur
- Prizler
- Sıcaklık kontrolü
- Senaryo kontrolü
- Tüketim detayı görüntüleme
- Bildirimler alabilme
- Planlanabilir programlar

NASIL KONTROL ETMEK İSTERSEN

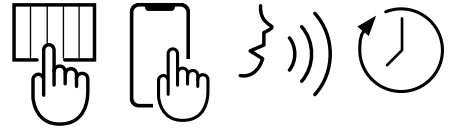

Livinglight

Anahtarlar	6
Diğer Anahtarlar	7
Prizler	8
TV Prizleri	9
Data ve Telefon Prizleri	9
Elektronik Prizler	10
Audio Video Prizler	10
Dimmerler	10
Hareket Sensörleri	11
Termostatlar	11
Otel Çözümleri	11
İkaz ve Sinyal Lambaları	12
LED Lambalar	13
Boşluk Kapakları	13
Tuş Kapakları	14
Kaideler	16
Polimer Plastik Çerçevesel	17
Metal Çerçevesel	18
Living International Çerçevesel	18
AIR Çerçevesel	19

Living Now

Anahtarlar	34
Diğer Anahtarlar	35
Prizler	38
TV Prizleri	42
Data ve Telefon Prizleri	43
Elektronik Prizler	44
Audio Video Prizler	45
Dimmerler	46
Termostatlar	46
Hareket Sensörleri	47
Otel Çözümleri	48
İkaz ve Sinyal Lambaları	49
LED Lambalar	50
Boşluk Kapakları	50
Tuş Kapakları	51
Kaideler	52
Polimer Plastik Çerçevesel	53
Metal Çerçevesel	54
Ahşap Çerçevesel	54

Living Now with Netatmo

Bağlı Aydınlatma Kontrol Cihazları	58
Kablosuz Aydınlatma Kontrol Cihazları	59
Bağlı Perde/Panjur Kontrol Cihazları	60
Kablosuz Perde/Panjur Kontrol Cihazları	61
Bağlı Enerji Yönetim Cihazları	62
Prizli Ağ Geçidi Modülü	63
Ağ Geçidi Modülleri	64
Bağlı Termostatlar	64
Kablosuz Senaryo Kontrol Cihazları	65

LivingLight with Netatmo

Bağlı Aydınlatma Kontrol Cihazları	66
Kablosuz Aydınlatma Kontrol Cihazları	66
Bağlı Perde/Panjur Kontrol Cihazları	67
Kablosuz Perde/Panjur Kontrol Cihazları	67
Bağlı Enerji Yönetim Cihazları	67
Prizli Ağ Geçidi Modülü	67
Bağlı Termostatlar	68
Ağ Geçidi Modülleri	68
Kablosuz Senaryo Kontrol Cihazları	68

Axolute

Anahtarlar	22
Diğer Anahtarlar	22
Prizler	23
TV Prizleri	24
Data ve Telefon Prizleri	24
Elektronik Prizler	25
Audio Video Prizler	25
Hareket Sensörleri	25
Termostatlar	25
Otel Çözümleri	26
İkaz ve Sinyal Lambaları	26
LED Lambalar	27
Boşluk Kapakları	27
Tuş Kapakları	28
Kaideler	29
AIR Çerçevesel	29

Classia with Netatmo

Baęlı Aydınlatma Kontrol Cihazları	70
Kablosuz Aydınlatma Kontrol Cihazları	70
Baęlı Perde/Panjur Kontrol Cihazları	71
Kablosuz Perde/Panjur Kontrol Cihazları	71
Baęlı Enerji Yönetim Cihazları	71
Prizli Ağ Geçidi Modülü	71
Baęlı Termostatlar	72
Ağ Geçidi Modülleri	72
Kablosuz Senaryo Kontrol Cihazları	72

Classia by Bticino

Anahtarlar	76
Hareket Sensörleri	77
Dimmerler	77
Prizler	78
Tv Prizleri	78
Data Ve Telefon Prizleri	79
İkaz Ve Sinyal Mekanizmaları	79
Boşluk Kapakları	79
Otel Çözümleri	80
Kaideler	80
IP Korumalı Buatlar ve Çerçeveler	80
Yalın Çerçeveler	81
Çerçvelİ Çerçeveler	81
Renkli Çerçeveler	82
Çarpıcı Çerçeveler	82

Kurulum Ekipmanları

Buatlar	85
Koruma Kılıfları ve Aksesuarlar	85
IP Korumalı Buatlar ve Çerçeveler - Living Light	86
Kurulum Aksesuarları	86

Teknik Çizimler

Classia by Bticino Kaide ve Çerçeveler	89
Livinglight Kaide ve Çerçeveler	90
Axolute Kaide ve Çerçeveler	93
Living Now Kaide ve Çerçeveler	94



LIVINGLIGHT^{AIR}

Kusursuzluğun zarif eseri

Zarafet ve teknoloji, LIVINGLIGHT ile bir arada









LIVINGLIGHT
DİKDÖRTGEN
ÇERÇEVELER





ANAHTARLAR

REF.	STANDART ANAHTARLAR	AMB.	AD/€	REF.	STANDART ANAHTARLAR	AMB.	AD/€		
□ N4001A		10	5,560	□ N4001M2A	Anahtar, 16AX, 250V~, Otomatik Bağlantı, 2M	10	7,580		
■ L4001A				■ L4001M2A				10	7,580
■ NT4001A				■ NT4001M2A				10	8,340
○ LN4001A	Anahtar, Mekanizma, 1M	10	4,600	○ -	-	-	-		
□ N4003A		10	7,520	□ N4003M2A	Vavien, 16AX, 250V~, Otomatik Bağlantı, 2M	10	8,270		
■ L4003A				■ L4003M2A				10	8,270
■ NT4003A				■ NT4003M2A				10	9,100
○ LN4003A	Vavien Mekanizma, 1M	10	5,860	○ -	-	-	-		
□ N4004N		10	12,500	□ N4004M2N	Permütatör, 16AX, 250V~, Vidalı Bağlantı, 2M	10	16,180		
■ L40004N				■ L40004M2N				10	16,180
■ NT4004N				■ NT4004M2N				10	17,790
○ LN4004	Permütatör Mekanizma, 1M	10	10,920	○ -	-	-	-		
□ N4005A		10	5,690	□ N4005M2A	Liht Butonu, 10A, 250V~, Otomatik Bağlantı, NA Kontak, 2M	10	6,770		
■ L4005A				■ L4005M2A				10	6,770
■ NT4005A				■ NT4005M2A				10	7,450
○ LN4005A	Liht Mekanizma, 1M	10	4,600	○ -	-	-	-		

REF.	AXIAL ANAHTARLAR	AMB.	AD/€	REF.	AXIAL ANAHTARLAR	AMB.	AD/€		
□ N4051AN		10	8,990	□ N4051M2AN	Axial Anahtar, 10AX, 250V~, Otomatik Bağlantı, 2M	10	10,320		
■ L4051AN				■ L4051M2AN				10	10,320
■ NT4051AN				■ NT4051M2AN				10	13,170
□ N4053AN		10	11,210	□ N4053M2AN	Axial Vavien, 10AX, 250V~, Otomatik Bağlantı, 2M	10	12,310		
■ L4053AN				■ L4053M2AN				10	12,310
■ NT4053AN				■ NT4053M2AN				10	15,540
□ N4054		10	22,330	□ N4054M2	Axial Permütatör, 16A, 250V~, Otomatik Bağlantı, 2M	10	27,790		
■ L40054				■ L40054M2				10	27,790
■ NT4054				■ NT4054M2				10	30,570
□ N4055AN		10	9,670	□ N4055M2AN	Axial Liht, 10A, 250V~, Otomatik Bağlantı, NA Kontak, 2M	10	11,310		
■ L4055AN				■ L4055M2AN				10	11,310
■ NT4055AN				■ NT4055M2AN				10	14,420



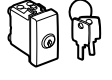

DİĞER ANAHTARLAR



REF.	2 KUTUPLU ANAHTARLAR	AMB.	AD/€	REF.	KİLİTLİ VAVİEN	AMB.	AD/€		
□ N4002N		10	10,420	□ N4022	Kilitli Vavien, 16AX, 250V~, Vidalı Bağlantı, 1M	1	102,450		
■ L4002N				■ L4022				1	102,450
■ NT4002N				■ NT4022				1	112,690
□ N4012		1	116,150	□ N4022C*	Kilitli Vavien, 16AX, 250V~, Vidalı Bağlantı, 1M	1	115,150		
■ L4012				■ L4022C*				1	115,150
■ NT4012				■ NT4022C*				1	126,670
□ N4012C*		1	115,150	□ N4011	İki Kutuplu Anahtar, 32A, 250V~, Vidalı Bağlantı, 1M	10	25,120		
■ L4012C*				■ L4011				10	25,120
■ NT4012C*				■ NT4011				10	27,630









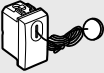

* Sipariş vermek için lütfen satış ofisimize danışınız.

* N4022C, NT4022C ve L4022C için tüm anahtarlar standarttır.

DİĞER ANAHTARLAR (DEVAM)



REF.	JALUZİ KUMANDA ANAHTARLARI	AMB.	AD/€	REF.	FAN KONTROL ANAHTARLARI	AMB.	AD/€
<input type="checkbox"/> N4027N <input checked="" type="checkbox"/> L4027N <input checked="" type="checkbox"/> NT4027N	 Jaluzi Kumanda Anahtarı, 16A, 250V~, Vidalı Bağlantı, Enversör Tip (1-0-2), İki Tuşlu, 1M	10	18,170 18,170 19,980	<input type="checkbox"/> N4027VMCN <input checked="" type="checkbox"/> L4027VMCN <input checked="" type="checkbox"/> NT4027VMCN	 Fan Kontrol Anahtarı, 16A, 250V~, Vidalı Bağlantı, Enversör Tip (1-0-2), İki Tuşlu, 1M	10	18,170 18,170 19,980
<input type="checkbox"/> N4037N <input checked="" type="checkbox"/> L4037N <input checked="" type="checkbox"/> NT4037N	 Mekanik Kilitlemeli Jaluzi Kumanda Anahtarı, 10A, 250V~, Vidalı Bağlantı, NA+NA Kontak, 1M	10	18,170 18,170 19,980	<input type="checkbox"/> N4016 <input checked="" type="checkbox"/> L4016 <input checked="" type="checkbox"/> NT4016	 Çevirmeli Fan Kontrol Anahtarı, 3A, 250V~, Vidalı Bağlantı, Dört Kademeli, 2M	1	42,090 42,090 46,300

REF.	JACK BAĞLANTISI	AMB.	AD/€
<input type="checkbox"/> N4391 <input checked="" type="checkbox"/> L4391 <input checked="" type="checkbox"/> NT4391	 Jack Bağlantısı, 10A, 48V~, Vidalı Bağlantı, İki Kontaklı, 1M	10	22,630 22,630 24,890
<input type="checkbox"/> 2124N	 L/N/NT4391 için Fiş/Jack	10	4,250









REF.	LİHT BUTONLARI	AMB.	AD/€	REF.	LİHT BUTONLARI	AMB.	AD/€
<input type="checkbox"/> N4034N <input checked="" type="checkbox"/> L4034N <input checked="" type="checkbox"/> NT4034N	 Liht Butonu, 10A, 250V~, Vidalı Bağlantı, NK Kontak, Değiştirilebilir Kapak, 1M	10	5,560 5,560 6,120	<input type="checkbox"/> LN4040*	 Etiketli Liht Butonu, 10A, 250V~, Vidalı Bağlantı, NA Kontak, 2M	10	15,480
<input type="checkbox"/> N4033 <input checked="" type="checkbox"/> L4033 <input checked="" type="checkbox"/> NT4033	 Liht Butonu, 10A, 250V~, Vidalı Bağlantı, NA Kontak, Kordonlu, 1M	1	12,400 12,400 13,650	<input type="checkbox"/> N4042N* <input checked="" type="checkbox"/> L4042N* <input checked="" type="checkbox"/> NT4042N*	 Zil Sembollü Liht Butonu, 10A, 250V~, Vidalı Bağlantı, NA Kontak, 1M	10	6,330 6,330 7,380
<input type="checkbox"/> N4038R* <input checked="" type="checkbox"/> L4038R* <input checked="" type="checkbox"/> NT4038R*	 Liht Butonu, 10A, 250V~, Vidalı Bağlantı, NA Kontak, Kırmızı Göstergeli, 1M	10	14,590 14,590 16,050	<input type="checkbox"/> N4042M2N* <input checked="" type="checkbox"/> L4042M2N* <input checked="" type="checkbox"/> NT4042M2N*	 Zil Sembollü Liht Butonu, 10A, 250V~, Vidalı Bağlantı, NA Kontak, 2M	10	7,130 7,130 8,240
<input type="checkbox"/> N4038V* <input checked="" type="checkbox"/> L4038V* <input checked="" type="checkbox"/> NT4038V*	 Liht Butonu, 10A, 250V~, Vidalı Bağlantı, NA Kontak, Yeşil Göstergeli, 1M	10	14,590 14,590 16,050	<input type="checkbox"/> N4043N* <input checked="" type="checkbox"/> L4043N* <input checked="" type="checkbox"/> NT4043N*	 Işık Sembollü Liht Butonu, 10A, 250V~, Vidalı Bağlantı, NA Kontak, 1M	10	6,330 6,330 7,380
<input type="checkbox"/> N4044N <input checked="" type="checkbox"/> L4044N <input checked="" type="checkbox"/> NT4044N	 İki Kutuplu Liht Butonu, 10A, 250V~, Vidalı Bağlantı, Bağımsız NA Kontak, 1M	10	8,340 8,340 9,170	<input type="checkbox"/> N4043M2N* <input checked="" type="checkbox"/> L4043M2N* <input checked="" type="checkbox"/> NT4043M2N*	 Işık Sembollü Liht Butonu, 10A, 250V~, Vidalı Bağlantı, NA Kontak, 2M	10	7,130 7,130 8,240
				<input type="checkbox"/> 26108N** <input checked="" type="checkbox"/> 26108L** <input checked="" type="checkbox"/> 26108T**	 IP55 Etiketli Liht Butonu, 10A, 250V~, Vidalı Bağlantı, 3M	1	50,330 50,330 50,330

* LN4742V12T ve LN4742V230T referanslı LED lambalar ile donatılabilir.

** Lamba ürüne dahildir.

REF.	TUŞ KAPAKLARI	AMB.	AD/€
<input type="checkbox"/> N4916DP <input checked="" type="checkbox"/> L4916DP <input checked="" type="checkbox"/> NT4916DP	 Tuş Kapağı, 0.5M	10	4,170 4,170 4,900
<input type="checkbox"/> N4916DPA <input checked="" type="checkbox"/> L4916DPA <input checked="" type="checkbox"/> NT4916DPA	 Ok Sembollü Tuş Kapağı, 0.5M	10	3,980 3,980 4,370

PRİZLER

REF.	ALMAN STANDARDI	AMB.	AD/€	REF.	İTALYAN STANDARDI	AMB.	AD/€
<input type="checkbox"/> N4141TR <input checked="" type="checkbox"/> L4141TR <input checked="" type="checkbox"/> NT4141TR	 Alman Standardı Topraklı Priz, 16A, 250V~, Vidalı Bağlantı, Çocuk Korumalı, 2M	10	9,690 9,690 10,660	<input type="checkbox"/> N4113 <input checked="" type="checkbox"/> L4113 <input checked="" type="checkbox"/> NT4113	 İtalyan Standardı Topraklı Priz, 10A, 250V~, Vidalı Bağlantı, Çocuk Korumalı, 1M	10	5,130 5,130 5,640
<input type="checkbox"/> N4141PW <input checked="" type="checkbox"/> L4141PW <input checked="" type="checkbox"/> NT4141PW	 Alman Standardı Kapaklı Topraklı Priz, 16A, 250V~, Vidalı Bağlantı, Çocuk Korumalı, 2M	5	16,380 16,380 18,010				
<input type="checkbox"/> N4141AN <input checked="" type="checkbox"/> L4141AN <input checked="" type="checkbox"/> NT4141AN	 Alman Standardı Topraklı Priz, 16A, 250V~, Otomatik Bağlantı, Çocuk Korumalı, 2M	10	8,660 8,660 9,530	<input type="checkbox"/> N4150 <input checked="" type="checkbox"/> L4150 <input checked="" type="checkbox"/> NT4150	 İngiliz Standardı Topraklı Priz, 13A, 250V~, Vidalı Bağlantı, 2M	10	22,330 22,330 24,570
<input type="radio"/> L4141R	 Alman Standardı Topraklı Priz, 16A, 250V~, Vidalı Bağlantı, Çocuk Korumalı, Kırmızı, 2M	10	9,000	<input type="checkbox"/> N4151 <input checked="" type="checkbox"/> NT4151	İngiliz Standardı Anahtarlı Topraklı Priz, 13A, 250V~, Vidalı Bağlantı, 2M	10	38,710 42,580
<input type="radio"/> L4141V	 Alman Standardı Topraklı Priz, 16A, 250V~, Vidalı Bağlantı, Çocuk Korumalı, Yeşil, 2M	10	9,000	<input type="checkbox"/> N4152 <input checked="" type="checkbox"/> NT4152	İkili İngiliz Standardı Anahtarlı Topraklı Priz, 13A, 250V~, Vidalı Bağlantı, 4M	5	59,460 65,410
REF.	FRANSIZ STANDARDI	AMB.	AD/€	REF.	TIRAŞ PRİZİ	AMB.	AD/€
<input type="checkbox"/> N4142 <input checked="" type="checkbox"/> L4142 <input checked="" type="checkbox"/> NT4142	 Fransız Standardı Topraklı Priz, 16A, 250V~, Vidalı Bağlantı, Çocuk Korumalı, 2M	10	10,120 10,120 11,130	<input type="checkbox"/> N4177* <input checked="" type="checkbox"/> L4177* <input checked="" type="checkbox"/> NT4177*	 Tıraş Prizi, 230V~, 20VA, 3M	1	97,090 97,090 106,800
<input type="checkbox"/> N4142AN <input checked="" type="checkbox"/> L4142AN <input checked="" type="checkbox"/> NT4142AN	 Fransız Standardı Topraklı Priz, 16A, 250V~, Otomatik Bağlantı, Çocuk Korumalı, 2M	10	9,740 9,740 10,720				
<input type="radio"/> L4142AR	 Fransız Standardı Topraklı Priz, 16A, 250V~, Vidalı Bağlantı, Çocuk Korumalı, Kırmızı, 2M	10	10,620				

* Livinglight Air çerçeveler ile birlikte kullanırken kolay kablolama için buat genişletme aksesuarı kullanılması önerilir.

Not: Diğer uluslararası standartlara uygun prizler için satış ofisimize danışınız.

TV PRİZLER

REF.	TV PRİZLERİ	AMB.	AD/€
<input type="checkbox"/> N4202DN	 TV Prizi, Yıldız Bağlantı, 1M	1	13,790
<input type="checkbox"/> N4202M2DN	 TV Prizi, Yıldız Bağlantı, 2M	1	26,500
<input type="checkbox"/> N4202P14N	 TV Prizi, 14 dB, Geçişli, 1M	1	16,870
<input type="checkbox"/> N4202P10N	 TV Prizi, 10 dB, Sonlu, 1M	1	16,180
<input type="checkbox"/> N4202FN	 TV Prizi, F Tipi, 1M	1	12,400











REF.	TV / SAT PRİZLERİ	AMB.	AD/€
<input type="checkbox"/> N4214DN	 TV-SAT Prizi, 1M	1	21,930
<input type="checkbox"/> N4214M2DN	 TV-SAT Prizi, 2M	1	24,420

REF.	TV / R / SAT PRİZLERİ	AMB.	AD/€
<input type="checkbox"/> N4210M2DN	 TV-R-SAT Prizi, 2M	1	39,110







REF.	TV PRİZ VE SOKETİ	AMB.	AD/€
<input type="checkbox"/> S2133	 Beyaz TV Fişi	12	3,870

REF.	SONLANDIRMA DİRENCİ	AMB.	AD/€
<input type="checkbox"/> 75RTN	 Sonlandırma Direnci, 75 Ohm	10	3,470









DATA VE TELEFON PRİZLERİ

REF.	DATA PRİZLERİ	AMB.	AD/€
<input type="checkbox"/> N4279C5E	 Data Prizi, CAT5e UTP, Aletsiz, 1M	10	12,500
<input checked="" type="checkbox"/> L4279C5E			12,500
<input checked="" type="checkbox"/> NT4279C5E			13,750
<input type="checkbox"/> N4279C5F	 Data Prizi, CAT5e FTP, Aletsiz, 1M	10	20,540
<input checked="" type="checkbox"/> L4279C5F			20,540
<input checked="" type="checkbox"/> NT4279C5F			22,600
<input type="checkbox"/> N4279C6	 Data Prizi, CAT6 UTP, Aletsiz, 1M	10	16,870
<input checked="" type="checkbox"/> L4279C6			16,870
<input checked="" type="checkbox"/> NT4279C6			18,560
<input type="checkbox"/> N4279C6F	 Data Prizi, CAT6 FTP, Aletsiz, 1M	10	21,930
<input checked="" type="checkbox"/> L4279C6F			21,930
<input checked="" type="checkbox"/> NT4279C6F			24,130
<input type="checkbox"/> N4279C6S	 Data Prizi, CAT6 STP, Aletsiz, 1M	1	21,640
<input checked="" type="checkbox"/> L4279C6S			21,640
<input checked="" type="checkbox"/> NT4279C6S			23,800
<input type="checkbox"/> N4279C6A	 Data Prizi, CAT6A STP, Aletsiz, 1M	1	35,540
<input checked="" type="checkbox"/> L4279C6A			35,540
<input checked="" type="checkbox"/> NT4279C6A			39,090
<input type="checkbox"/> N4262C5E	 Data Prizi, CAT5e UTP, 110 IDC, 1M	1	18,760
<input checked="" type="checkbox"/> L4262C5E			18,760
<input checked="" type="checkbox"/> NT4262C5E			20,630
<input type="checkbox"/> N4262C6	 Data Prizi, CAT6 UTP, 110 IDC, 1M	1	18,760
<input checked="" type="checkbox"/> L4262C6			18,760
<input checked="" type="checkbox"/> NT4262C6			20,630
<input type="checkbox"/> N4262C6S	 Data Prizi, CAT6 STP, 110 IDC, 1M	1	21,340
<input checked="" type="checkbox"/> L4262C6S			21,340
<input checked="" type="checkbox"/> NT4262C6S			23,470
<input type="checkbox"/> N4258/11N	 Telefon Prizi, RJ11, 1M	1	15,080
<input checked="" type="checkbox"/> L4258/11N			15,080
<input checked="" type="checkbox"/> NT4258/11N			16,590





ELEKTRONİK PRİZLER

REF.	USB ŞARJ PRİZLERİ	AMB.	AD/€
□ N4287C2 ■ L4287C2 ■ NT4287C2	 A+C Tipi USB Şarj Prizi, 3A, 230V~/5VDC, 2M	1	55,590 55,590 61,150
□ N4286C2 ■ L4286C2 ■ NT4286C2	 C Tipi USB Şarj Prizi, 3A, 230V~/5VDC, 2M	1	65,910 65,910 72,510
□ N4191A ■ L4191A ■ NT4191A	 A Tipi USB Şarj Prizi, 3A, 100-240V~, 1M	1	28,520 28,520 31,380
□ N4192C ■ L4192C ■ NT4192C	 C Tipi USB Şarj Prizi, 3A, 100-240V~, 1M	1	40,730 40,730 44,800
□ N4191AC ■ L4191AC ■ NT4191AC	 A+C Tipi USB Şarj Prizi, 3A, 100-240V~, 1M	1	55,590 55,590 61,150
□ N4191AA ■ L4191AA ■ NT4191AA	 A+A Tipi USB Şarj Prizi, 3A, 100-240V~, 1M	1	45,170 45,170 49,680
□ N4191CC ■ L4191CC ■ NT4191CC	 C+C Tipi USB Şarj Prizi, 3A, 100-240V~, 1M	1	65,910 65,910 72,510

AUDIO VIDEO PRİZLER



REF.	AUDIO VIDEO PRİZLER	AMB.	AD/€
□ N4269R ■ L4269R ■ NT4269R	 İki RCA Konnektör, Kaynak İle Bağlantı, Sarı - Kırmızı Kontakt, 1M	1	23,620 23,620 25,990
□ N4294 ■ L4294 ■ NT4294	 Hoparlör Konnektörü, 1M	1	22,230 22,230 24,460
□ N4280 ■ L4280 ■ NT4280	 3.5 mm Jack Konnektörü, 1M	1	22,230 22,230 24,460
□ N4281 ■ L4281 ■ NT4281	 İki RCA Konnektör, Beyaz - Kırmızı Kontakt, 1M	1	29,880 29,880 32,860
□ N4282 ■ L4282 ■ NT4282	 VGA Konnektör, 2M	1	35,630 35,630 39,200
□ N4283 ■ L4283 ■ NT4283	 Üçlü RCA Konnektör, Sarı - Kırmızı Kontakt, 1M	1	35,630 35,630 39,200
□ N4284 ■ L4284 ■ NT4284	 Önceden sonlandırılmış HDMI Konnektör, 2M	1	35,540 35,540 39,090
□ N4285 ■ L4285 ■ NT4285	 USB Data Prizi, 1M	1	28,690 28,690 31,550

DİMMERLER

REF.	ROTATİF DİMMERLER	AMB.	AD/€	REF.	DOKUNMATİK DİMMERLER	AMB.	AD/€
□ N4402N* ■ L4402N* ■ NT4402N*	 Vavien Rotatif Dimmer, 230V~, 60-500W, 1M	1	49,430 49,430 54,380	□ N4410N ■ L4410N ■ NT4410N	 0-10V Dokunmatik Dimmer, 240V~, 300-600W, 2M	1	102,120 102,120 111,220
□ N4406* ■ L4406* ■ NT4406*	 Rotatif Dimmer, 230V~, 100-500W, 1M	1	31,160 31,160 34,280	□ N4582N ■ L4582N ■ NT4582N	 Dokunmatik Dimmer, 240V~, 400-700W, 2M	1	83,680 83,680 92,050
□ N4581 ■ L4581 ■ NT4581	 Rotatif Dimmer, 230V~, 400/800W, 1M	1	67,010 67,010 73,710				





* AIR Çerçeveler ile birlikte kullanımda estetik bir görünüm için dokunmatik dimmer veya universal dimmer kullanımı önerilir. Eğer rotatif dimmer kurulumu yapılıyorsa, kolay kablolama için buat genişletme aksesuarı kullanılması önerilir.

HAREKET SENSÖRLERİ

REF.	HAREKET SENSÖRLERİ	AMB.	AD/€
□ N4433N ■ L4433N ■ NT4433N	 Dual Sensörlü (PIR + Ultrasonik) Hareket Sensörü, 2.5A, 230V~, 2000W, 8m, 2M	1	160,030 160,030 176,030
□ N4434N ■ L4434N ■ NT4434N	 PIR Hareket Sensörü, 1.7A, 230V~, 400W, 8m, 2M	1	160,030 160,030 176,030
□ N4431N ■ L4431N ■ NT4431N	 PIR Hareket Sensörü, 2A, 230V~, 200W, 6m, 105°, 1M	1	101,950 101,950 112,150
□ N4432 ■ L4432 ■ NT4432	 PIR Hareket Sensörü, 6A, 230V~, 500W, 6m, 105°, 2M	1	114,460 114,460 125,900
□ N4003ES ■ L4003ES ■ NT4003ES	 PIR Hareket Sensörü, 230V~, 150W, 8m, 160°, Nötrsız, 2M	1	69,690 69,690 76,660

Not: Hareket sensörü seçimi konusunda ayrıntılı bilgi için ürün kataloğunu inceleyiniz.

OTEL ÇÖZÜMLERİ





REF.	ENERGY SAVER	AMB.	AD/€
○ LN4549	 Mekanik Anahtarlı Energy Saver, 230V~, 2M	1	94,010
○ LN4548	 RFID Energy Saver, 230V~, 2M	1	132,920
REF.	ENERGY SAVER TUŞ KAPAKLARI	AMB.	AD/€
□ N4547 ■ L4547 ■ NT4547	 Energy Saver Ürünleri İçin Kapak, 2M	1	20,940 20,940 23,040
□ N4551 ■ L4551 ■ NT4551	 Energy Saver Ürünleri İçin Kapak, 3M	1	26,500 26,500 29,150

REF.	DİMLENEBİLİR OKUMA LAMBASI	AMB.	AD/€
□ N4362 ■ L4362 ■ NT4362	 Dimlenebilir Okuma Lambası, 1M	1	160,030 160,030 176,030



REF.	OTEL ÇAĞRI ÜNİTELERİ	AMB.	AD/€
□ N4373H ■ L4373H ■ NT4373H	 Otel Çağrı Göstergesi, 1M	10	20,940 20,940 23,040
□ N4028HN ■ L4028HN	 Otel Çağrı Butonu, 16A, 250V~, DND/MUR Sembollü, 1M	10	13,010 13,010



* Farklı energy saver çözümlerimiz için satış ofisimize danışınız.





TERMOSTATLAR

REF.	TERMOSTATLAR	AMB.	AD/€
□ N4441 ■ L4441 ■ NT4441	 Elektronik Ortam Termostatı, 2A, 250V~, 2M	1	125,380 125,380 137,920
□ N4441FH ■ L4441FH ■ NT4441FH	 Elektronik Ortam Termostatı, 2A, 250V~, Harici Sensör Bağlantılı, 2M	1	121,310 121,310 133,440
□ N4442 ■ L4442 ■ NT4442	 Elektronik Ortam Termostatı, 2A, 250V~, Yaz/Kış Seçimli, 2M	1	132,920 132,920 146,220
□ N4451 ■ L4451 ■ NT4451	 Programlanabilir Ortam Termostatı, Pili, Harici Sensör Bağlantılı, 3M	1	256,820 256,820 282,500
○ 3457	 Harici sensör, 5m	1	28,000







İKAZ VE SİNYAL MEKANİZMALARI

REF.	ZİLLER	AMB.	AD/€
□ N4351/12 ■ L4351/12 ■ NT4351/12	 Zil, 12V~, 5VA, 80 dB, 1M	10	20,350 20,350 22,380
□ N4351/230 ■ L4351/230 ■ NT4351/230	 Zil, 230V~, 8VA, 80 dB, 1M	10	25,410 25,410 27,950
□ N4355/12 ■ L4355/12 ■ NT4355/12	 Elektronik Zil, 12V~/12VDC, 2M	1	66,710 66,710 73,380



REF.	BUZZER	AMB.	AD/€
□ N4356/12 ■ L4356/12 ■ NT4356/12	 Buzzer, 12V~, 5VA, 74 dB, 1M	10	14,090 14,090 15,500
□ N4356/230 ■ L4356/230 ■ NT4356/230	 Buzzer, 230V~, 8VA, 75 dB, 1M	10	18,560 18,560 20,420

REF.	KILAVUZ LAMBALARI	AMB.	AD/€
□ N4371T* ■ L4371T* ■ NT4371T*	 Transparan Gösterge Lambası, 1M	10	8,960 8,960 9,860
□ N4371R* ■ L4371R* ■ NT4371R*	 Kırmızı Gösterge Lambası, 1M	10	8,960 8,960 9,860
□ N4371V* ■ L4371V* ■ NT4371V*	 Yeşil Gösterge Lambası, 1M	10	8,960 8,960 9,860
□ N4372AV* ■ L4372AV* ■ NT4372AV*	 Turuncu ve Yeşil Gösterge Lambası, 1M	10	12,600 12,600 13,860

* LN4742V12T ve LN4742V230T ile donatılabilir.



REF.	SİNYAL MEKANİZMALARI	AMB.	AD/€
■ L4385/12R ■ L4385/12V ■ L4385/12B	 Sinyalizasyon Lambası, 12V~, 1M	1	27,390
■ L4385/24R ■ L4385/24V ■ L4385/24B	 Sinyalizasyon Lambası, 24V~, 1M	1	27,100
■ L4385/230R ■ L4385/230V ■ L4385/230B	 Sinyalizasyon Lambası, 230V~, 1M	1	29,380
○ L4745/12	 Lamba, 12V~, 5W, E10	10	10,720
○ L4745/24	 Lamba, 24V~, 5W, E10	10	10,720
○ L4745/230	 Lamba, 230V~, 5W, E10	10	10,720

REF.	SİNYAL LAMBALARI	AMB.	AD/€
○ L4374V12V24	 Sinyal Lambası, 12/24V~, 2M	10	32,260
○ L4374/230	 Sinyal Lambası, 230V~, 2M	10	22,930

REF.	MERDİVEN BASAMAĞI LAMB.	AMB.	AD/€
○ L4382V12V24	 Merdiven Basamağı Aydınlatması, 12/24V~, 2M	10	28,390
○ L4382/230	 Merdiven Basamağı Aydınlatması, 230V~, 2M	10	28,390





REF.	360° ODAKLI LAMBA	AMB.	AD/€
○ LN4360	 360° Odaklı Lamba, 2M	1	69,690

REF.	YÖNLÜ ZEMİN LAMBASI	AMB.	AD/€
○ LN4361	 Yönlü Zemin Lambası, 2M	1	90,340

REF.	TAŞINABİLİR LAMBA	AMB.	AD/€
○ LN4380N	 Taşınabilir Lamba, 230V~, 2M	1	49,830
○ 4380NB	 LN4380N için Batarya	1	11,810

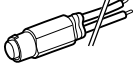
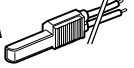
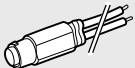
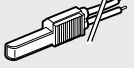
REF.	ACİL DURUM LAMBASI	AMB.	AD/€
○ L4384/1	 Acil Durum Aydınlatma Lambası, 230V~, 4M	1	165,190
○ L4386/1	 Acil Durum Aydınlatma Lambası, 230V~, 6M	1	174,220
○ L4784/1	 L4384/1 için Batarya	1	26,500
○ L4786/1	 L4384/1 için Batarya	3	35,140

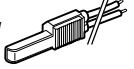
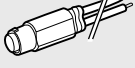
LED LAMBALAR

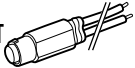
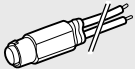
REF.	STANDART ANAHTARLAR İÇİN	AMB.	AD/€	REF.	AXIAL ANAHTARLAR İÇİN	AMB.	AD/€
○ LN4742V230	 LED Lamba, 230V~, Kehribar	100	3,120	○ LN4743/230A	 LED Lamba, 230V~, Kehribar	10	3,120
○ LN4742V12	 LED Lamba, 12/24V~, Kehribar	100	3,120	○ LN4743/12A	 LED Lamba, 12/24V~, Kehribar	10	3,120
○ LN4742V230V	 LED Lamba, 230V~, Yeşil	100	3,120	○ LN4743/230V	 LED Lamba, 230V~, Yeşil	10	3,120
○ LN4742V12V	 LED Lamba, 12/24V~, Yeşil	100	3,120	○ LN4743/12V	 LED Lamba, 12/24V~, Yeşil	10	3,120
○ LN4742V230T	 Pilot Lamba, 230V~, Beyaz	100	3,520	○ LN4743/230T	LED Lamba, 230V~, Beyaz	10	3,600
○ LN4742V12T	 Pilot Lamba, 12V~, Beyaz	100	3,520	○ LN4743/12T	LED Lamba, 12/24V~, Beyaz	10	3,600
				○ H4743/230B	LED Lamba, 230V~, Mavi	10	3,520
				○ H4743/12B	LED Lamba, 12V~, Mavi	10	3,520

* LED lamba seçimi konusunda ayrıntılı bilgi için ürün kataloğunu inceleyiniz.

BOŞLUK KAPAKLARI

REF.	BOŞLUK KAPAKLARI	AMB.	AD/€
□ N4950 ■ L4950 ■ NT4950	 Boşluk Kapağı, 1M	10	1,020 1,020 1,460
□ N4951 ■ L4951 ■ NT4951	 Kırılabilir Bölmeli Boşluk Kapağı, 2M	5	1,800 1,800 2,900
□ N4953 ■ L4953 ■ NT4953	 Kablo Çıkış Kapağı, 1M	10	4,900 4,900 5,390
□ N4954 ■ L4954 ■ NT4954	 Kablo Çıkış Kapağı, 2M	10	15,480 15,480 18,420

STANDART ANAHTAR TUŞ KAPAKLARI

N4915N



NT4915N



L4915N



N4915LN

REF.	TUŞ KAPAKLARI	AMB.	AD/€	REF.	TUŞ KAPAKLARI	AMB.	AD/€	REF.	TUŞ KAPAKLARI	AMB.	AD/€
□ N4915N ■ L4915N ■ NT4915N	Sembolsüz Tuş Kapağı, 1M	10	4,170 4,170 5,050	□ N4915M2N ■ L4915M2N ■ NT4915M2N	Sembolsüz Tuş Kapağı, 2M	10	5,160 5,160 5,960	□ N4915M3N ■ L4915M3N ■ NT4915M3N	Sembolsüz Tuş Kapağı, 3M	10	7,540 7,540 8,290
□ N4915LN	Sembolsüz Tuş Kapağı, Yüksek Parlaklığı, 1M	10	5,950	□ N4915M2LN	Sembolsüz Tuş Kapağı, Yüksek Parlaklığı, 2M	10	8,930	□ N4915M3LN	Sembolsüz Tuş Kapağı, Yüksek Parlaklığı, 3M	10	8,930



NT4915AN



NT4915BN



NT4915DN



NT4915FN



NT4915M2ADN



NT4915DD



NT4915MR

REF.	SEMBOLLÜ TUŞ KAPAKLARI	AMB.	AD/€	REF.	SEMBOLLÜ TUŞ KAPAKLARI	AMB.	AD/€
□ N4915AN ■ L4915AN ■ NT4915AN	Işık Sembollü Tuş Kapağı, 1M	10	8,510	□ N4915M2AN ■ L4915M2AN ■ NT4915M2AN	Işık Sembollü Tuş Kapağı, 2M	10	9,670 9,670 10,640
□ N4915BN ■ L4915BN ■ NT4915BN	Merdiven Aydınlatması Sembollü Tuş Kapağı, 1M	10	8,510	□ N4915M2BN ■ L4915M2BN ■ NT4915M2BN	Merdiven Aydınlatması Sembollü Tuş Kapağı, 2M	10	9,670 9,670 10,640
□ N4915DN ■ L4915DN ■ NT4915DN	Zil Sembollü Tuş Kapağı, 1M	10	8,510	□ N4915M2DN ■ L4915M2DN ■ NT4915M2DN	Zil Sembollü Tuş Kapağı, 2M	10	9,670 9,670 10,640
□ N4915FN ■ L4915FN ■ NT4915FN	Anahtar Sembollü Tuş Kapağı, 1M	10	8,510	□ N4915M2FN ■ L4915M2FN ■ NT4915M2FN	Anahtar Sembollü Tuş Kapağı, 2M	10	9,670 9,670 10,640
□ N4915DD ■ L4915DD ■ NT4915DD	DND Sembollü Tuş Kapağı, 1M	10	8,510	□ N4915M2ADN ■ L4915M2ADN ■ NT4915M2ADN	Dimmer Sembollü Tuş Kapağı, 2M	10	9,670 9,670 10,640
□ N4915MR ■ L4915MR ■ NT4915MR	MUR Sembollü Tuş Kapağı, 1M	10	8,510	□ N4915M2DD ■ L4915M2DD ■ NT4915M2DD	DND Sembollü Tuş Kapağı, 2M	10	9,670 9,670 10,640

AXIAL ANAHTAR TUŞ KAPAKLARI



NT4916

REF.	SEMBOLSÜZ TUŞ KAPAKLARI	AMB.	AD/€	REF.	SEMBOLSÜZ TUŞ KAPAKLARI	AMB.	AD/€
□ N4916 ■ L4916 ■ NT4916	Sembolsüz Tuş Kapağı, 1M	10	4,170 4,170 5,050	□ N4916M2 ■ L4916M2 ■ NT4916M2	Işık Sembollü Tuş Kapağı, 2M	10	5,460 5,460 5,540



NT4916A



NT4916B



NT4916D



NT4916F

REF.	SEMBOLLÜ TUŞ KAPAKLARI	AMB.	AD/€	REF.	SEMBOLLÜ TUŞ KAPAKLARI	AMB.	AD/€
□ N4916A ■ L4916A ■ NT4916A	Işık Sembollü Tuş Kapağı, 1M	10	8,510	□ N4916M2A ■ L4916M2A ■ NT4916M2A	Işık Sembollü Tuş Kapağı, 2M	10	9,670 9,670 10,640
□ N4916B ■ L4916B ■ NT4916B	Merdiven Aydınlatması Sembollü Tuş Kapağı, 1M	10	8,510	□ N4916M2B ■ L4916M2B ■ NT4916M2B	Merdiven Aydınlatması Sembollü Tuş Kapağı, 2M	10	9,670 9,670 10,640
□ N4916D ■ L4916D ■ NT4916D	Zil Sembollü Tuş Kapağı, 1M	10	8,510	□ N4916M2D ■ L4916M2D ■ NT4916M2D	Zil Sembollü Tuş Kapağı, 2M	10	9,670 9,670 10,640
□ N4916F ■ L4916F ■ NT4916F	Anahtar Sembollü Tuş Kapağı, 1M	10	8,510	□ N4916M2F ■ L4916M2F ■ NT4916M2F	Anahtar Sembollü Tuş Kapağı, 2M	10	9,670 9,670 10,640



NT4916T





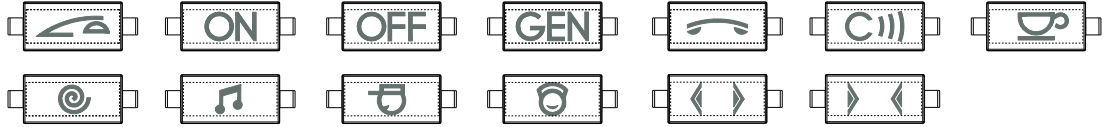









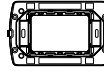

NT4916M2T

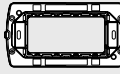

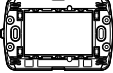
REF.	KİŞİSELLEŞTİRİLEBİLİR TUŞ KPK.	AMB.	AD/€	REF.	KİŞİSELLEŞTİRİLEBİLİR TUŞ KPK.	AMB.	AD/€
□ N4916T ■ L4916T ■ NT4916T	Kişiselleştirilebilir Tuş Kapağı, 1M	10	5,160 5,160 5,670	□ N4916M2T ■ L4916M2T ■ NT4916M2T	Kişiselleştirilebilir Tuş Kapağı, 2M	10	5,160 5,160 5,670

KAİDELER

REF.	PLASTİK KAİDELER	AMB.	AD/€	REF.	GEÇMELİ UYGULAMA - AIR İÇİN	AMB.	AD/€
○ LN4702G	 Plastik Kaide, Tırnaklı, 2M	100	2,880	○ LN4702E	 Living Light Air LNE... Serisi Çerçeve İçin Kaide, Plastik, 2M	10	5,460
○ LN4702	 Plastik Kaide, Vidalı, 2M	100	1,500	REF.	MODÜLER UYGULAMA - AIR İÇİN	AMB.	AD/€
○ LN4702MG	 Metal Kaide, Tırnaklı, 2M	100	5,950	○ LN4702E	 Living Light Air LNE... Serisi Çerçeve İçin Kaide, Plastik, 2M	10	5,460
○ LN4702M	 Metal Kaide, Vidalı, 2M	100	2,540	○ LN4702C	 Living Light Air LNC... Serisi Çerçeve İçin Kaide, Plastik, 2M	10	1,760
REF.	METAL KAİDELER	AMB.	AD/€	○ LN4703C	 Living Light Air LNC... Serisi Çerçeve İçin Kaide, Plastik, 3M	20	1,760
○ L4702G	 Living Light International Çerçeve için Plastik Kaide, Tırnaklı, 2M	100	4,960	○ LN4704C	 Living Light Air LNC... Serisi Çerçeve İçin Kaide, Plastik, 4M	10	3,200
○ L4702	 Living Light International Çerçeve için Plastik Kaide, Vidalı, 2M	100	1,520	○ LN4707C	 Living Light Air LNC... Serisi Çerçeve İçin Kaide, Plastik, 7M	10	6,090
○ LN4703	 Living Light ve Living Light International Çerçeve İçin Plastik Kaide, Vidalı, 3M	10	1,500	○ LN4726C	 Living Light Air LNC... Serisi Çerçeve İçin Kaide, Plastik, 3+3M	10	7,070
○ LN4704	 Living Light ve Living Light International Çerçeve İçin Plastik Kaide, Vidalı, 4M	10	2,880				
○ LN4707	 Living Light ve Living Light International Çerçeve İçin Plastik Kaide, Vidalı, 7M	50	5,320				
○ LN4726	 Living Light ve Living Light International Çerçeve İçin Plastik Kaide, Vidalı, 3+3M	20	4,960				

POLİMER PLASTİK ÇERÇEVELER

REF.	POLİMER PLASTİK ÇERÇEVELER	AMB.	AD/€	REF.	POLİMER PLASTİK ÇERÇEVELER	AMB.	AD/€
LNA4802BI	Çerçeve, Beyaz, 2M	1	3,280	LNA4802KG	Çerçeve, Buz, 2M	1	7,550
LNA4803BI	Çerçeve, Beyaz, 3M	1	3,280	LNA4803KG	Çerçeve, Buz, 3M	1	7,550
LNA4804BI	Çerçeve, Beyaz, 4M	1	4,950	LNA4804KG	Çerçeve, Buz, 4M	1	11,170
LNA4807BI	Çerçeve, Beyaz, 7M	1	7,180	LNA4807KG	Çerçeve, Buz, 7M	1	19,140
LNA4802M2BI	Çerçeve, Beyaz, 2+2M	1	5,850	LNA4802M2KG	Çerçeve, Buz, 2+2M	1	13,780
LNA4802M3BI	Çerçeve, Beyaz, 2+2+2M	1	9,430	LNA4802M3KG	Çerçeve, Buz, 2+2+2M	1	20,460
LNA4802M4BI	Çerçeve, Beyaz, 2+2+2+2M	1	11,320	LNA4802M4KG	Çerçeve, Buz, 2+2+2+2M	1	26,430
LNA4826BI	Çerçeve, Beyaz, 3+3M	1	7,550	LNA4826KG	Çerçeve, Buz, 3+3M	1	18,870
LNA4802AR	Çerçeve, Antrasit, 2M	1	3,280				
LNA4803AR	Çerçeve, Antrasit, 3M	1	3,280				
LNA4804AR	Çerçeve, Antrasit, 4M	1	4,950				
LNA4807AR	Çerçeve, Antrasit, 7M	1	7,180				
LNA4802M2AR	Çerçeve, Antrasit, 2+2M	1	5,850				
LNA4802M3AR	Çerçeve, Antrasit, 2+2+2M	1	9,430				
LNA4802M4AR	Çerçeve, Antrasit, 2+2+2+2M	1	11,320				
LNA4826AR	Çerçeve, Antrasit, 3+3M	1	7,550				
LNA4802TE	Çerçeve, Alüminyum, 2M	1	5,640				
LNA4803TE	Çerçeve, Alüminyum, 3M	1	5,640				
LNA4804TE	Çerçeve, Alüminyum, 4M	1	8,770				
LNA4807TE	Çerçeve, Alüminyum, 7M	1	12,210				
LNA4802M2TE	Çerçeve, Alüminyum, 2+2M	1	10,940				
LNA4802M3TE	Çerçeve, Alüminyum, 2+2+2M	1	14,830				
LNA4802M4TE	Çerçeve, Alüminyum, 2+2+2+2M	1	19,650				
LNA4826TE	Çerçeve, Alüminyum, 3+3M	1	16,990				
LNA4802KF	Çerçeve, Sis, 2M	1	7,550				
LNA4803KF	Çerçeve, Sis, 3M	1	7,830				
LNA4804KF	Çerçeve, Sis, 4M	1	11,170				
LNA4807KF	Çerçeve, Sis, 7M	1	19,140				
LNA4802M2KF	Çerçeve, Sis, 2+2M	1	13,780				
LNA4802M3KF	Çerçeve, Sis, 2+2+2M	1	20,460				
LNA4802M4KF	Çerçeve, Sis, 2+2+2+2M	1	26,430				
LNA4826KF	Çerçeve, Sis, 3+3M	1	18,870				
LNA4802KA	Çerçeve, Akvamarin, 2M	1	7,550				
LNA4803KA	Çerçeve, Akvamarin, 3M	1	7,550				
LNA4804KA	Çerçeve, Akvamarin, 4M	1	11,170				
LNA4807KA	Çerçeve, Akvamarin, 7M	1	19,140				
LNA4802M2KA	Çerçeve, Akvamarin, 2+2M	1	13,780				
LNA4802M3KA	Çerçeve, Akvamarin, 2+2+2M	1	20,460				
LNA4802M4KA	Çerçeve, Akvamarin, 2+2+2+2M	1	26,430				
LNA4826KA	Çerçeve, Akvamarin, 3+3M	1	18,870				

METAL ÇERÇEVELER

REF.	METAL ÇERÇEVELER	AMB.	AD/€
LNA4802AE	Çerçeve, Kum, 2M	1	14,490
LNA4803AE	Çerçeve, Kum, 3M	1	14,490
LNA4804AE	Çerçeve, Kum, 7M	1	20,250
LNA4807AE	Çerçeve, Kum, 7M	1	31,370
LNA4802M2AE	Çerçeve, Kum, 2+2M	1	45,300
LNA4802M3AE	Çerçeve, Kum, 2+2+2M	1	49,080
LNA4802M4AE	Çerçeve, Kum, 2+2+2+2M	1	71,730
LNA4826AE	Çerçeve, Kum, 3+3M	1	46,210
LNA4802SQ	Çerçeve, Toprak, 2M	1	14,490
LNA4803SQ	Çerçeve, Toprak, 3M	1	14,490
LNA4804SQ	Çerçeve, Toprak, 7M	1	20,250
LNA4807SQ	Çerçeve, Toprak, 7M	1	31,370
LNA4802M2SQ	Çerçeve, Toprak, 2+2M	1	45,300
LNA4802M3SQ	Çerçeve, Toprak, 2+2+2M	1	49,080
LNA4802M4SQ	Çerçeve, Toprak, 2+2+2+2M	1	71,730
LNA4826SQ	Çerçeve, Toprak, 3+3M	1	46,210
LNA4802AG	Çerçeve, Gümüş, 2M	1	17,170
LNA4803AG	Çerçeve, Gümüş, 3M	1	17,170
LNA4804AG	Çerçeve, Gümüş, 4M	1	25,010
LNA4807AG	Çerçeve, Gümüş, 7M	1	37,720
LNA4802M2AG	Çerçeve, Gümüş, 2+2M	1	49,460
LNA4802M3AG	Çerçeve, Gümüş, 2+2+2M	1	52,480
LNA4802M4AG	Çerçeve, Gümüş, 2+2+2+2M	1	79,290
LNA4826AG	Çerçeve, Gümüş, 3+3M	1	47,120

LIVING INTERNATIONAL ÇERÇEVELER

REF.	ELİPTİK ÇERÇEVELER	AMB.	AD/€
L4802PB	Çerçeve, Beyaz, 2M	1	4,360
L4803PB	Çerçeve, Beyaz, 3M	1	4,360
L4804PB	Çerçeve, Beyaz, 4M	1	6,350
L4807PB	Çerçeve, Beyaz, 7M	1	9,430
L4802PA	Çerçeve, Koyu Çelik, 2M	1	4,360
L4803PA	Çerçeve, Koyu Çelik, 3M	1	4,360
L4804PA	Çerçeve, Koyu Çelik, 4M	1	6,350
L4807PA	Çerçeve, Koyu Çelik, 7M	1	9,430
L4802BI	Çerçeve, Tam Beyaz, 2M	1	13,890
L4803BI	Çerçeve, Tam Beyaz, 3M	1	13,890
L4804BI	Çerçeve, Tam Beyaz, 4M	1	20,250
L4807BI	Çerçeve, Tam Beyaz, 7M	1	30,080
L4802GF	Çerçeve, Grafit, 2M	5	17,640
L4803GF	Çerçeve, Grafit, 3M	10	17,640
L4804GF	Çerçeve, Grafit, 4M	5	25,500
L4807GF	Çerçeve, Grafit, 7M	1	38,450
L4826GF	Çerçeve, Grafit, 3+3M	1	56,630
L4802GFN	Çerçeve, Siyah Grafit, 2M	1	17,640
L4803GFN	Çerçeve, Siyah Grafit, 3M	1	17,640
L4804GFN	Çerçeve, Siyah Grafit, 4M	1	25,500
L4807GFN	Çerçeve, Siyah Grafit, 7M	1	38,450
L4826GFN	Çerçeve, Siyah Grafit, 3+3M	1	56,630
L4802TE	Çerçeve, Alüminyum, 2M	1	18,260
L4803TE	Çerçeve, Alüminyum, 3M	10	18,260
L4804TE	Çerçeve, Alüminyum, 4M	1	26,400
L4807TE	Çerçeve, Alüminyum, 7M	1	39,800
L4802AL	Çerçeve, Alüminyum, 2M	5	29,720
L4803AL	Çerçeve, Alüminyum, 3M	10	29,720
L4804AL	Çerçeve, Alüminyum, 4M	5	42,950
L4807AL	Çerçeve, Alüminyum, 7M	1	65,300
L4826AL	Çerçeve, Alüminyum, 3+3M	1	87,160
L4802TC	Çerçeve, Titanyum, 2M	5	29,720
L4803TC	Çerçeve, Titanyum, 3M	10	29,720
L4804TC	Çerçeve, Titanyum, 4M	1	42,950
L4807TC	Çerçeve, Titanyum, 7M	1	65,300
L4826TC	Çerçeve, Titanyum, 3+3M	1	87,160
L4802AC	Çerçeve, Koyu Çelik, 2M	5	29,720
L4803AC	Çerçeve, Koyu Çelik, 3M	10	29,720
L4804AC	Çerçeve, Koyu Çelik, 4M	5	42,950
L4807AC	Çerçeve, Koyu Çelik, 7M	1	65,300
L4826AC	Çerçeve, Koyu Çelik, 3+3M	1	87,160

AIR ÇERÇEVELER

REF.	MODÜLER SİSTEM İÇİN	AMB.	AD/€
LNC4802TE	Çerçeve, Alüminyum, 2M	1	17,540
LNC4803TE	Çerçeve, Alüminyum, 3M	1	17,540
LNC4804TE	Çerçeve, Alüminyum, 4M	1	20,050
LNC4826TE	Çerçeve, Alüminyum, 3+3M	1	29,680
LNC4807TE	Çerçeve, Alüminyum, 7M	1	29,980
LNC4802ST	Çerçeve, Füme, 2M	1	17,540
LNC4803ST	Çerçeve, Füme, 3M	1	17,540
LNC4804ST	Çerçeve, Füme, 4M	1	20,050
LNC4826ST	Çerçeve, Füme, 3+3M	1	29,680
LNC4807ST	Çerçeve, Füme, 7M	1	29,980
LNC4802CY	Çerçeve, Toprak, 2M	1	17,540
LNC4803CY	Çerçeve, Toprak, 3M	1	17,540
LNC4804CY	Çerçeve, Toprak, 4M	1	20,050
LNC4826CY	Çerçeve, Toprak, 3+3M	1	29,680
LNC4807CY	Çerçeve, Toprak, 7M	1	29,980
LNC4802BM	Çerçeve, Mavi Ay, 2M	1	17,540
LNC4803BM	Çerçeve, Mavi Ay, 3M	1	17,540
LNC4804BM	Çerçeve, Mavi Ay, 4M	1	20,050
LNC4826BM	Çerçeve, Mavi Ay, 3+3M	1	29,680
LNC4807BM	Çerçeve, Mavi Ay, 7M	1	29,980
LNC4802BN	Çerçeve, Beyaz, 2M	1	18,160
LNC4803BN	Çerçeve, Beyaz, 3M	1	18,160
LNC4804BN	Çerçeve, Beyaz, 4M	1	20,050
LNC4826BN	Çerçeve, Beyaz, 3+3M	1	29,680
LNC4807BN	Çerçeve, Beyaz, 7M	1	29,980
LNC4802AR	Çerçeve, Antrasit, 2M	1	18,160
LNC4803AR	Çerçeve, Antrasit, 3M	1	18,160
LNC4804AR	Çerçeve, Antrasit, 4M	1	20,050
LNC4826AR	Çerçeve, Antrasit, 3+3M	1	29,680
LNC4807AR	Çerçeve, Antrasit, 7M	1	29,980
LNC4802SB	Çerçeve, Kum, 2M	1	18,160
LNC4803SB	Çerçeve, Kum, 3M	1	18,160
LNC4804SB	Çerçeve, Kum, 4M	1	20,050
LNC4826SB	Çerçeve, Kum, 3+3M	1	29,680
LNC4807SB	Çerçeve, Kum, 7M	1	29,980
LNC4802PR	Çerçeve, İnci Beyazı, 2M	1	22,930
LNC4803PR	Çerçeve, İnci Beyazı, 3M	1	22,930
LNC4804PR	Çerçeve, İnci Beyazı, 4M	1	33,450
LNC4826PR	Çerçeve, İnci Beyazı, 3+3M	1	45,960
LNC4807PR	Çerçeve, İnci Beyazı, 7M	1	50,630

AIR ÇERÇEVELER

REF.	GEÇMELİ SİSTEM İÇİN	AMB.	AD/€
LNE4802BN	Çerçeve, Beyaz, 2M	1	19,480
LNE4802M2BN	Çerçeve, Beyaz, 2+2M	1	29,980
LNE4802M3BN	Çerçeve, Beyaz, 2+2+2M	1	40,800
LNE4802TE	Çerçeve, Alüminyum, 2M	1	19,480
LNE4802M2TE	Çerçeve, Alüminyum, 2+2M	1	29,980
LNE4802M3TE	Çerçeve, Alüminyum, 2+2+2M	1	40,800



BEYAZ TASARIM

Air çerçevede Beyaz,
Alüminyum ve Antrasit
tasarım. Mükemmel
koordinasyon ve kontrol.

AXOLUTE AIR

Axolute ^{Air} İNCE BİR DEVRİM

3.5mm incelik



Metal

sağlam, dayanıklı,
kararlı

Akılcı Çizgiler

son derece ince detaylarla
tasarlandı









Axolute Renkler

farklı ve
benzersiz renk

ANAHTARLAR











REF.	AXIAL ANAHTARLAR	AMB.	AD/€	REF.	AXIAL ANAHTARLAR	AMB.	AD/€
<input type="checkbox"/> HD4001AN <input type="checkbox"/> HC4001AN <input type="checkbox"/> HS4001AN	 Axial Anahtar, 10AX, 250V~, Otomatik Bağlantı, 1M	10	14,140	<input type="checkbox"/> HD4001M2AN <input type="checkbox"/> HC4001M2AN <input type="checkbox"/> HS4001M2AN	 Axial Anahtar, 10AX, 250V~, Otomatik Bağlantı, 2M	10	16,930
<input type="checkbox"/> HD4003AN <input type="checkbox"/> HC4003AN <input type="checkbox"/> HS4003AN	 Axial Vavien, 10AX, 250V~, Otomatik Bağlantı, 1M	10	18,430	<input type="checkbox"/> HD4003M2AN <input type="checkbox"/> HC4003M2AN <input type="checkbox"/> HS4003M2AN	 Axial Vavien, 10AX, 250V~, Otomatik Bağlantı, 2M	10	20,460
<input type="checkbox"/> HD4004 <input type="checkbox"/> HC4004 <input type="checkbox"/> HS4004	 Axial Permütatör, 16AX, 250V~, Vidalı Bağlantı, 1M	10	45,970	<input type="checkbox"/> HD4004M2 <input type="checkbox"/> HC4004/2 <input type="checkbox"/> HS4004/2	 Axial Permütatör, 16AX, 250V~, Vidalı Bağlantı, 2M	10	57,220
<input type="checkbox"/> HD4005AN <input type="checkbox"/> HC4005AN <input type="checkbox"/> HS4005AN	 Axial Liht, 10A, 250V~, Otomatik Bağlantı, NA Kontak, 1M	10	14,680	<input type="checkbox"/> HD4005M2AN <input type="checkbox"/> HC4005M2AN <input type="checkbox"/> HS4005M2AN	 Axial Liht, 10A, 250V~, Otomatik Bağlantı, NA Kontak, 2M	10	24,220

DİĞER ANAHTARLAR

REF.	2 KUTUPLU ANAHTARLAR	AMB.	AD/€	REF.	FAN KONTROL ANAHTARLARI	AMB.	AD/€
<input type="checkbox"/> HD4002 <input type="checkbox"/> HC4002 <input type="checkbox"/> HS4002	 İki Kutuplu Anahtar, 16AX, 250V~, Vidalı Bağlantı, 1M	10	20,680	<input type="checkbox"/> HD4016 <input type="checkbox"/> HC4016 <input type="checkbox"/> HS4016	 Çevirmeli Fan Kontrol Anahtarı, 3A, 250V~, Vidalı Bağlantı, Dört Kademeli, 2M	1	59,480
<input type="checkbox"/> HD4011 <input type="checkbox"/> HC4011 <input type="checkbox"/> HS4011	 İki Kutuplu Anahtar, 32A, 250V~, Vidalı Bağlantı, 1M	10	52,400				
REF.	JALUZİ KUMANDA ANAHTARLARI	AMB.	AD/€	REF.	LİHT BUTONLARI	AMB.	AD/€
<input type="checkbox"/> HD4027 <input type="checkbox"/> HC4027 <input type="checkbox"/> HS4027	 Jaluzi Kumanda Anahtarı, 16A, 250V~, Vidalı Bağlantı, Enversör Tip (1-0-2), İki Tuşlu, 1M	10	37,180	<input type="checkbox"/> HD4033 <input type="checkbox"/> HC4033 <input type="checkbox"/> HS4033	 Liht Butonu, 10 A, 250V~, Vidalı Bağlantı, NA Kontak, Kordonlu, 1M	1	23,890
<input type="checkbox"/> HD4037 <input type="checkbox"/> HC4037 <input type="checkbox"/> HS4037	 Mekanik Kilitlemeli Jaluzi Kumanda Anahtarı, 10A, 250V~, Vidalı Bağlantı, NA+NA Kontak, 1M	10	45,330	<input type="checkbox"/> HD4044 <input type="checkbox"/> HC4044 <input type="checkbox"/> HS4044	 İki Kutuplu Liht Butonu, 10A, 250V~, Vidalı Bağlantı, Bağımsız NA Kontak, 1M	10	21,430
				<input type="checkbox"/> H4040	 Etiketli Liht Butonu, 3A, 250V~, Vidalı Bağlantı, NA Kontak, Üç Renk, 2M	10	43,510
				<input type="checkbox"/> HD4034N <input type="checkbox"/> HC4034N <input type="checkbox"/> HS4034N	 Liht Butonu, 10A, 250V~, Vidalı Bağlantı, NA/NK Kontak, 1M	10	16,390

* Sipariş vermek için lütfen satış ofisimize danışınız.



PRİZLER

REF.	ALMAN STANDARDI	AMB.	AD/€	REF.	İNGİLİZ STANDARDI	AMB.	AD/€
□ HD4141TR ■ HC4141TR ■ HS4141TR	 Alman Standardı Topraklı Priz, 16A, 250V~, Vidalı Bağlantı, Çocuk Korumalı, 2M	10	18,430	□ HD4150 ■ HC4150 ■ HS4150	 İngiliz Standardı Topraklı Priz, 13A, 250V~, Vidalı Bağlantı, 2M	10	34,290
□ HD4141W ■ HC4141W ■ HS4141W	 Alman Standardı Topraklı Priz, 16A, 250V~, Otomatik Bağlantı, Çocuk Korumalı, 2M	10	26,570	□ HD4151 ■ HC4151 ■ HS4151	 İngiliz Standardı Anahtarlı Topraklı Priz, 13A, 250V~, Vidalı Bağlantı, 2M	5	75,980
□ HD4141PW ■ HC4141PW ■ HS4141PW	 Alman Standardı Kapaklı Topraklı Priz, 16A, 250V~, Vidalı Bağlantı, Çocuk Korumalı, 2M	5	30,860	□ HD4152 ■ HC4152 ■ HS4152	 İkili İngiliz Standardı Anahtarlı Topraklı Priz, 13A, 250V~, Vidalı Bağlantı, 4M	5	113,810
○ H4141R	 Alman Standardı Topraklı Priz, 16A, 250V~, Vidalı Bağlantı, Çocuk Korumalı, Kırmızı, 2M	5	14,680				
REF.	FRANSIZ STANDARDI	AMB.	AD/€	REF.	TIRAŞ PRİZİ	AMB.	AD/€
□ HD4142AN ■ HC4142AN ■ HS4142AN	 Fransız Standardı Topraklı Priz, 16A, 250V~, Otomatik Bağlantı, Çocuk Korumalı, 2M	10	19,820	□ HD4177* ■ HC4177* ■ HS4177*	 Tıraş Prizi, 230V~, 20VA, 3M	1	168,900
○ H4142R	 Fransız Standardı Topraklı Priz, 16A, 250V~, Vidalı Bağlantı, Çocuk Korumalı, Kırmızı, 2M	5	24,750				
REF.	İTALYAN STANDARDI	AMB.	AD/€				
□ HD4113 ■ HC4113 ■ HS4113	 İtalyan Standardı Topraklı Priz, 10A, 250V~, Vidalı Bağlantı, Çocuk Korumalı, 1M	10	12,530				
□ HD4180 ■ HC4180 ■ HS4180	 İtalyan Standardı Topraklı Priz, 10/16A, 250V~, Vidalı Bağlantı, Çocuk Korumalı, 1M	10	8,580				
REF.	AVRUPA / AMERİKA STANDARDI	AMB.	AD/€				
□ HD4125 ■ HC4125 ■ HS4125	 Avrupa/Amerika Standardı Priz, 16A, 127/250V~, Vidalı Bağlantı, 1M	10	22,720				
□ HD4126 ■ HC4126 ■ HS4126	 Avrupa/Amerika Standardı Priz, 16A, 127/250V~, Vidalı Bağlantı, 2M	10	27,540				
□ HD4185 ■ HC4185 ■ HS4185	 İkili Avrupa/Amerika Standardı Priz, 16A, 127/250V~, Vidalı Bağlantı, 3M	5	39,110				

* AXOLUTE AIR çerçeveler ile birlikte kullanılırken kolay kablolama için buat genişletme aksesuarı kullanılması önerilir.

Not: Diğer uluslararası standartlara uygun prizler için satış ofisimize danışınız.

TV PRİZLER

REF.	TV PRİZLERİ	AMB.	AD/€
○ H4202D*	 TV Priz, Yıldız Bağlantı, Üç Renk, 1M	1	30,650
○ H4202P14*	 TV Priz, 14 dB, Geçişli, Üç Renk, 1M	1	32,570
○ H4202P10*	 TV Priz, 10 dB, Sonlu, Üç Renk, 1M	1	32,570
○ H4202F*	 TV Priz, F Tipi, Üç Renk, 1M	1	34,720

REF.	TV / SAT PRİZLERİ	AMB.	AD/€
○ H4214D*	 TV-SAT Priz, Üç Renk, 1M	1	38,150
○ H4214M2D*	TV-SAT Priz, Üç Renk, 2M	1	66,120





REF.	TV / R / SAT PRİZLERİ	AMB.	AD/€
○ H4210M2D*	 TV-R-SAT Priz, Üç Renk, 2M	1	58,830

REF.	TV PRİZ VE SOKETİ	AMB.	AD/€
○ S2133	 Beyaz TV Fişi, Beyaz	12	3,870

REF.	SONLANDIRMA DİRENCİ	AMB.	AD/€
○ 75RTN	 Sonlandırma Direnci, 75 Ohm,	10	3,470

REF.	TV PRİZİ KAPAKLARI	AMB.	AD/€
□ HD4204 ■ HC4204 ■ HS4204	 TV-R Priz için Kapak, 2M	10	10,360
□ HD4207 ■ HC4207 ■ HS4207	 TV-R-SAT Priz için Kapak, 2M	10	10,930
□ HD4212 ■ HC4212 ■ HS4212	 TV/FM-SAT Priz için Kapak, 2M	10	10,260





DATA VE TELEFON PRİZLERİ

REF.	DATA PRİZLERİ	AMB.	AD/€
□ HD4279C6 ■ HC4279C6 ■ HS4279C6	 Data Priz, CAT6 UTP, Aletsiz, 1M	10	27,220
□ HD4279C6S ■ HC4279C6S ■ HS4279C6S	 Data Priz, CAT6 STP, Aletsiz, 1M	1	37,510
□ HD4279C6A ■ HC4279C6A ■ HS4279C6A	 Data Priz, CAT6A STP, Aletsiz, 1M	1	48,010
□ HD4262C6 ■ HC4262C6 ■ HS4262C6	 Data Priz, CAT6 UTP, 110 IDC, 1M	1	28,820
□ HD4262C6S ■ HC4262C6S ■ HS4262C6S	 Data Priz, CAT6 STP, 110 IDC, 1M	1	42,220





REF.	TELEFON PRİZLERİ	AMB.	AD/€
□ HD4258C11N ■ HC4258/11N ■ HS4258/11N	 Telefon Priz, RJ11, 1M	1	29,360

* Ürün ambalajında beyaz, alüminyum ve antrasit olmak üzere üç farklı tuş kapağı mevcuttur.





ELEKTRONİK PRİZLER

REF.	USB ŞARJ PRİZLERİ	AMB.	AD/€
<input type="checkbox"/> HD4285C1 <input type="checkbox"/> HC4285C1 <input type="checkbox"/> HS4285C1	 A Tipi USB Şarj Prizi, 1.5A, 230V~/5VDC, 1M	1	41,900
<input type="checkbox"/> HD4285C2 <input type="checkbox"/> HC4285C2 <input type="checkbox"/> HS4285C2	 A Tipi USB Şarj Prizi, 3A, 230V~/5VDC, 2M	1	62,580
<input type="checkbox"/> HD4287C2 <input type="checkbox"/> HC4287C2 <input type="checkbox"/> HS4287C2	 A+C Tipi USB Şarj Prizi, 3A, 230V~/5VDC, 2M	1	68,050
<input type="checkbox"/> HD4286C1 <input type="checkbox"/> HC4286C1 <input type="checkbox"/> HS4286C1	 C Tipi USB Şarj Prizi, 1.5A, 230V~/5VDC, 1M	1	42,220
<input type="checkbox"/> HD4286C2 <input type="checkbox"/> HC4286C2 <input type="checkbox"/> HS4286C2	 C Tipi USB Şarj Prizi, 3A, 230V~/5VDC, 2M	1	80,590



AUDIO VIDEO PRİZLER

REF.	AUDIO VIDEO PRİZLER	AMB.	AD/€
<input type="checkbox"/> HD4294 <input type="checkbox"/> HC4294 <input type="checkbox"/> HS4294	 Hoparlör Konnektörü, 1M	10	20,460
<input type="checkbox"/> HD4280 <input type="checkbox"/> HC4280 <input type="checkbox"/> HS4280	 3.5 mm Jack Konnektörü, 1M	1	36,110
<input type="checkbox"/> HD4281 <input type="checkbox"/> HC4281 <input type="checkbox"/> HS4281	 İkili RCA Konnektör, Beyaz - Kırmızı Kontak, 1M	1	36,110
<input type="checkbox"/> HD4284 <input type="checkbox"/> HC4284 <input type="checkbox"/> HS4284	 Önceden sonlandırılmış HDMI Konnektör, 2M	1	57,870
<input type="checkbox"/> HD4285 <input type="checkbox"/> HC4285 <input type="checkbox"/> HS4285	 USB Data Prizi, 1M	1	41,580

HAREKET SENSÖRLERİ

REF.	HAREKET SENSÖRLERİ	AMB.	AD/€
<input type="checkbox"/> HD4433 <input type="checkbox"/> HC4433 <input type="checkbox"/> HS4433	 Dual Sensörlü (PIR + Ultrasonik) Hareket Sensörü, 2.5A, 230V~, 2000W, 8m, 2M	1	225,270
<input type="checkbox"/> HD4434 <input type="checkbox"/> HC4434 <input type="checkbox"/> HS4434	 PIR Hareket Sensörü, 1.7A, 230V~, 400W, 8m, 2M	1	225,270
<input type="checkbox"/> HD4431N <input type="checkbox"/> HC4431N <input type="checkbox"/> HS4431N	 PIR Hareket Sensörü, 2A, 230V~, 200W, 6m, 105°, 1M	1	145,750
<input type="checkbox"/> HD4432 <input type="checkbox"/> HC4432 <input type="checkbox"/> HS4432	 PIR Hareket Sensörü, 6A, 230V~, 500W, 6m, 105°, 2M	1	164,180

TERMOSTATLAR









REF.	TERMOSTATLAR	AMB.	AD/€
<input type="checkbox"/> HD4451 <input type="checkbox"/> HC4451 <input type="checkbox"/> HS4451	 Programlanabilir Ortam Termostati, Pilleri, Harici Sensör Bağlantılı, 3M	1	422,250
<input type="checkbox"/> 3457	 Harici sensör, 5m	1	28,000

Not: Hareket sensörü seçimi konusunda ayrıntılı bilgi için ürün kataloğunu inceleyiniz.







* AIR Çerçevesel ile birlikte kullanımda estetik bir görünüm için dokunmatik dimmer veya universal dimmer kullanımı önerilir.

Not: Dimmer seçimi konusunda ayrıntılı bilgi için ürün kataloğunu inceleyiniz.

OTEL ÇÖZÜMLERİ

REF.	ENERGY SAVER	AMB.	AD/€	REF.	AXIAL ANAHLARLAR İÇİN TUŞ KPAK.	AMB.	AD/€
○ H4549	 Mekanik Anahtarlı Energy Saver, 230V~, 2M	1	172,010	<input type="checkbox"/> HD4921DD <input type="checkbox"/> HC4921DD <input type="checkbox"/> HS4921DD	 DND Sembollü Tuş Kapağı, 1M	10	14,030
○ H4548	 RFID Energy Saver, 230V~, 2M	1	265,890	<input type="checkbox"/> HD4921MR <input type="checkbox"/> HC4921MR <input type="checkbox"/> HS4921MR	 MUR Sembollü Tuş Kapağı, 1M	10	14,030
REF.	ENERGY SAVER TUŞ KAPAKLARI	AMB.	AD/€	REF.	OTEL ÇAĞRI GÖSTERGESİ	AMB.	AD/€
<input type="checkbox"/> HD4547 <input type="checkbox"/> HC4547 <input type="checkbox"/> HS4547	 Energy Saver Kapak, 2M	1	18,750	○ H4372V230H	 Otel Çağrı Göstergesi, 1M	1	80,910
REF.	SEMBOLLÜ TUŞ KAPAKLARI	AMB.	AD/€	REF.	DİMLENEBİLİR OKUMA LAMBASI	AMB.	AD/€
<input type="checkbox"/> HD4915DD <input type="checkbox"/> HC4915DD <input type="checkbox"/> HS4915DD	 DND Sembollü Tuş Kapağı, 1M	10	13,610	<input type="checkbox"/> HD4362 <input type="checkbox"/> HC4362 <input type="checkbox"/> HS4362	 Dimlenebilir Okuma Lambası, 1M	1	254,960
<input type="checkbox"/> HD4915M2DD <input type="checkbox"/> HC4915M2DD <input type="checkbox"/> HS4915M2DD	 DND Sembollü Tuş Kapağı, 2M	10	13,610				
<input type="checkbox"/> HD4915MR <input type="checkbox"/> HC4915MR <input type="checkbox"/> HS4915MR	 MUR Sembollü Tuş Kapağı, 1M	10	13,610				
<input type="checkbox"/> HD4915BL <input type="checkbox"/> HC4915BL <input type="checkbox"/> HS4915BL	 Oda Işığı Sembollü Tuş Kapağı, 1M	10	13,610				
<input type="checkbox"/> HD4915M2BL <input type="checkbox"/> HC4915M2BL <input type="checkbox"/> HS4915M2BL	 Oda Işığı Sembollü Tuş Kapağı, 2M	10	13,610				

İKAZ VE SİNYAL MEKANİZMALARI

REF.	ZİLLER	AMB.	AD/€	REF.	MERDİVEN BASAMAĞI LAMB.	AMB.	AD/€
<input type="checkbox"/> HD4351V12 <input type="checkbox"/> HC4351/12 <input type="checkbox"/> HS4351/12	 Zil, 12V~, 5VA, 80 dB, 1M	10	30,970	○ H4382V12V24	 Merdiven Basamağı Aydınlatması, 12/24V~, 2M	1	49,290
<input type="checkbox"/> HD4351V230 <input type="checkbox"/> HC4351/230 <input type="checkbox"/> HS4351/230	 Zil, 230V~, 8VA, 80 dB, 1M	10	25,180	○ H4382/230	 Merdiven Basamağı Aydınlatması, 230V~, 2M	1	57,870
REF.	BUZZER	AMB.	AD/€				
<input type="checkbox"/> HD4356V12 <input type="checkbox"/> HC4356/12 <input type="checkbox"/> HS4356/12	 Buzzer, 12V~, 5VA, 74 dB, 1M	10	21,110				
<input type="checkbox"/> HD4356V230 <input type="checkbox"/> HC4356/230 <input type="checkbox"/> HS4356/230	 Buzzer, 230V~, 8VA, 75 dB, 1M	10	32,790				

İKAZ VE SİNYAL MEKANİZMALARI (DEVAM)

REF.	YÖNLÜ ZEMİN LAMBASI	AMB.	AD/€
------	---------------------	------	------

○ H4361	 Yönlü Zemin Lambası, Üç Renk, 2M	1	145,110
---------	--	---	---------

REF.	TAŞINABİLİR LAMBA	AMB.	AD/€
------	-------------------	------	------

○ H4380N	 Taşınabilir Lamba, 230V~, Üç Renk, 2M	1	87,230
----------	---	---	--------

○ 4380NB	 LN4380N İçin Batarya,	1	11,810
----------	---	---	--------

REF.	ACİL DURUM LAMBASI	AMB.	AD/€
------	--------------------	------	------

○ H4384X1	 Acil Durum Aydınlatma Lambası, 230V~, Şeffaf, 4M	1	276,820
-----------	--	---	---------

○ L4386/1	 Acil Durum Aydınlatma Lambası, 230V~, Şeffaf, 6M	1	174,220
-----------	---	---	---------

○ L4784/1	 L4384/1 İçin Batarya,	1	26,500
-----------	---	---	--------

○ L4786/1	 L4386/1 ve L4386/1L İçin Batarya,	3	35,140
-----------	---	---	--------

REF.	SİGORTA TUTUCU	AMB.	AD/€
------	----------------	------	------

□ HD4321 ■ HC4321 ■ HS4321	 Sigorta Taşıyıcı, 10A, 250V~, 5X20 ve 6.3X32, 1M	10	21,750
----------------------------------	--	----	--------

LED LAMBALAR

REF.	LED LAMBALAR	AMB.	AD/€
------	--------------	------	------

○ H4743/230B	 LED Lamba, 230V~, Mavi	10	3,520
--------------	---	----	-------

○ H4743/12B	 LED Lamba, 12V~, Mavi	10	3,520
-------------	--	----	-------

○ LN4743/230A	 LED Lamba, 230V~, Kehribar	10	3,120
---------------	---	----	-------

○ LN4743/12A	 LED Lamba, 12/24V~, Kehribar	10	3,120
--------------	---	----	-------

○ LN4743/230V	 LED Lamba, 230V~, Yeşil	10	3,120
---------------	--	----	-------

○ LN4743/12V	 LED Lamba, 12/24V~, Yeşil	10	3,120
--------------	---	----	-------

○ LN4743/230T	 LED Lamba, 230V~, Beyaz	10	3,600
---------------	--	----	-------

○ LN4743/12T	 LED Lamba, 12/24V~, Beyaz	10	3,600
--------------	--	----	-------

BOŞLUK KAPAKLARI

REF.	BOŞLUK KAPAKLARI	AMB.	AD/€
------	------------------	------	------

□ HD4949 ■ HC4949 ■ HS4949	 Boşluk Kapağı, 0.5M	10	3,460
----------------------------------	---	----	-------

□ HD4950 ■ HC4950 ■ HS4950	 Boşluk Kapağı, 1M	10	3,460
----------------------------------	---	----	-------

□ HD4951 ■ HC4951 ■ HS4951	 Boşluk Kapağı, 2M	10	6,790
----------------------------------	---	----	-------

□ HD4953 ■ HC4953 ■ HS4953	 Kablo Çıkış Kapağı, 1M	1	10,330
----------------------------------	--	---	--------

□ HD4954 ■ HC4954 ■ HS4954	 Kablo Çıkış Kapağı, 2M	10	10,330
----------------------------------	--	----	--------

TUŞ KAPAKLARI

HC4921LA



HC4921LD



HC4921LF



HD4921LD



HD4921LF



HD4921LA



HC4921DD



HC4921MR



HC4921LE



HD4921LE







HD4921DD



HD4921MR

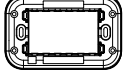



















REF.	SEMBOLLÜ TUŞ KAPAKLARI	AMB.	AD/€	REF.	SEMBOLLÜ TUŞ KAPAKLARI	AMB.	AD/€
<input type="checkbox"/> HD4921LA <input type="checkbox"/> HC4921LA <input type="checkbox"/> HS4921LA	Işık Sembollü Tuş Kapağı, 1M	10	14,030	<input type="checkbox"/> HD4921M2LA <input type="checkbox"/> HC4921/2LA <input type="checkbox"/> HS4921/2LA	Işık Sembollü Tuş Kapağı, 2M	10	16,390
<input type="checkbox"/> HD4921LD <input type="checkbox"/> HC4921LD <input type="checkbox"/> HS4921LD	Zil Sembollü Tuş Kapağı, 1M	10	14,030	<input type="checkbox"/> HD4921M2LD <input type="checkbox"/> HC4921/2LD <input type="checkbox"/> HS4921/2LD	Zil Sembollü Tuş Kapağı, 2M	10	16,390
<input type="checkbox"/> HD4921LF <input type="checkbox"/> HC4921LF <input type="checkbox"/> HS4921LF	Anahtar Sembollü Tuş Kapağı, 1M	10	14,030	<input type="checkbox"/> HD4921M2LF <input type="checkbox"/> HC4921/2LF <input type="checkbox"/> HS4921/2LF	Anahtar Sembollü Tuş Kapağı, 2M	10	16,390
<input type="checkbox"/> HD4921DD <input type="checkbox"/> HC4921DD <input type="checkbox"/> HS4921DD	DND Sembollü Tuş Kapağı, 1M	10	14,030	<input type="checkbox"/> HD4921M2LE <input type="checkbox"/> HC4921/2LE <input type="checkbox"/> HS4921/2LE	Fan Sembollü Tuş Kapağı, 2M	10	16,390
<input type="checkbox"/> HD4921MR <input type="checkbox"/> HC4921MR <input type="checkbox"/> HS4921MR	MUR Sembollü Tuş Kapağı, 1M	10	14,030				
<input type="checkbox"/> HD4921LE <input type="checkbox"/> HC4921LE <input type="checkbox"/> HS4921LE	Fan Sembollü Tuş Kapağı, 1M	10	14,030				

KAİDELER

REF.	AIR KAİDELER	AMB.	AD/€
○ H4703W	 AXOLUTE AIR Plastik Kaide, 3M	40	7,540
○ H4704W	 AXOLUTE AIR Plastik Kaide, 4M	10	8,410
○ H4706W	 AXOLUTE AIR Plastik Kaide, 6M	10	11,680
○ H4726W	 AXOLUTE AIR Plastik Kaide, 3+3M	10	10,310

REF.	KAİDELER	AMB.	AD/€
○ H4702G	 Eliptik ve Dikdörtgen Çerçeveler İçin Plastik Kaide, Tırnaklı, 2M	10	9,060
○ H4702	 Plastik Kaide, Vidalı, 2M	10	3,850
○ H4703	 Plastik Kaide, Vidalı, 3M	10	4,530
○ H4704	 Plastik Kaide, Vidalı, 4M	5	4,710
○ H4706	 Plastik Kaide, Vidalı, 6M	1	11,030
○ H4726	 Plastik Kaide, Vidalı, 3+3M	10	7,240

AIR ÇERÇEVELER

REF.	AIR ÇERÇEVELER	AMB.	AD/€
HW4819HD	 Çerçeve, Axolute Beyazı, 2M	1	43,830
HW4803HD	 Çerçeve, Axolute Beyazı, 3M	1	43,830
HW4804HD	 Çerçeve, Axolute Beyazı, 4M	1	59,900
HW4806HD	 Çerçeve, Axolute Beyazı, 6M	1	84,340
HW4826HDN	 Çerçeve, Axolute Beyazı, 3+3M	1	69,550
HW4819HC	 Çerçeve, Alüminyum, 2M	1	44,580
HW4803HC	 Çerçeve, Alüminyum, 3M	1	44,580
HW4804HC	 Çerçeve, Alüminyum, 4M	1	60,650
HW4806HC	 Çerçeve, Alüminyum, 6M	1	72,550
HW4826HCN	 Çerçeve, Alüminyum, 3+3M	1	58,190
HW4819HS	 Çerçeve, Antrasit, 2M	1	53,150
HW4803HS	 Çerçeve, Antrasit, 3M	1	53,150
HW4804HS	 Çerçeve, Antrasit, 4M	1	55,510
HW4806HS	 Çerçeve, Antrasit, 6M	1	85,840
HW4826HSN	 Çerçeve, Antrasit, 3+3M	1	57,220
HW4819AW	 Çerçeve, Parlak Beyaz, 2M	1	53,800
HW4803AW	 Çerçeve, Parlak Beyaz, 3M	1	53,800
HW4804AW	 Çerçeve, Parlak Beyaz, 4M	1	46,400
HW4806AW	 Çerçeve, Parlak Beyaz, 6M	1	89,480
HW4826AWN	 Çerçeve, Parlak Beyaz, 3+3M	1	69,550

LIVING
n o w®

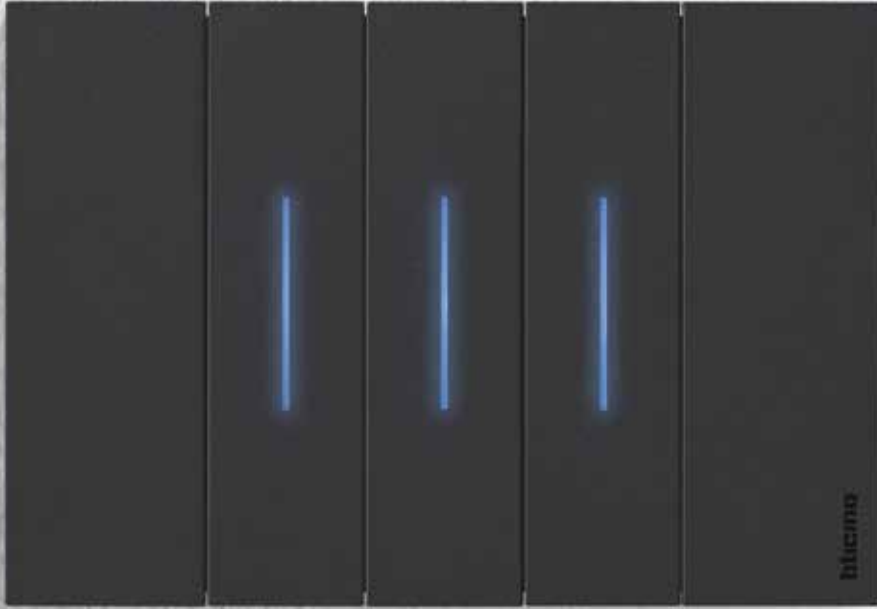

Zamansız tasarım, akıllı çözümler

Living ailesinin en yeni üyesi olan Living Now, zamansız tasarımının yanı sıra sunmuş olduğu akıllı çözümler ile sektörde bir devrime öncülük ediyor.

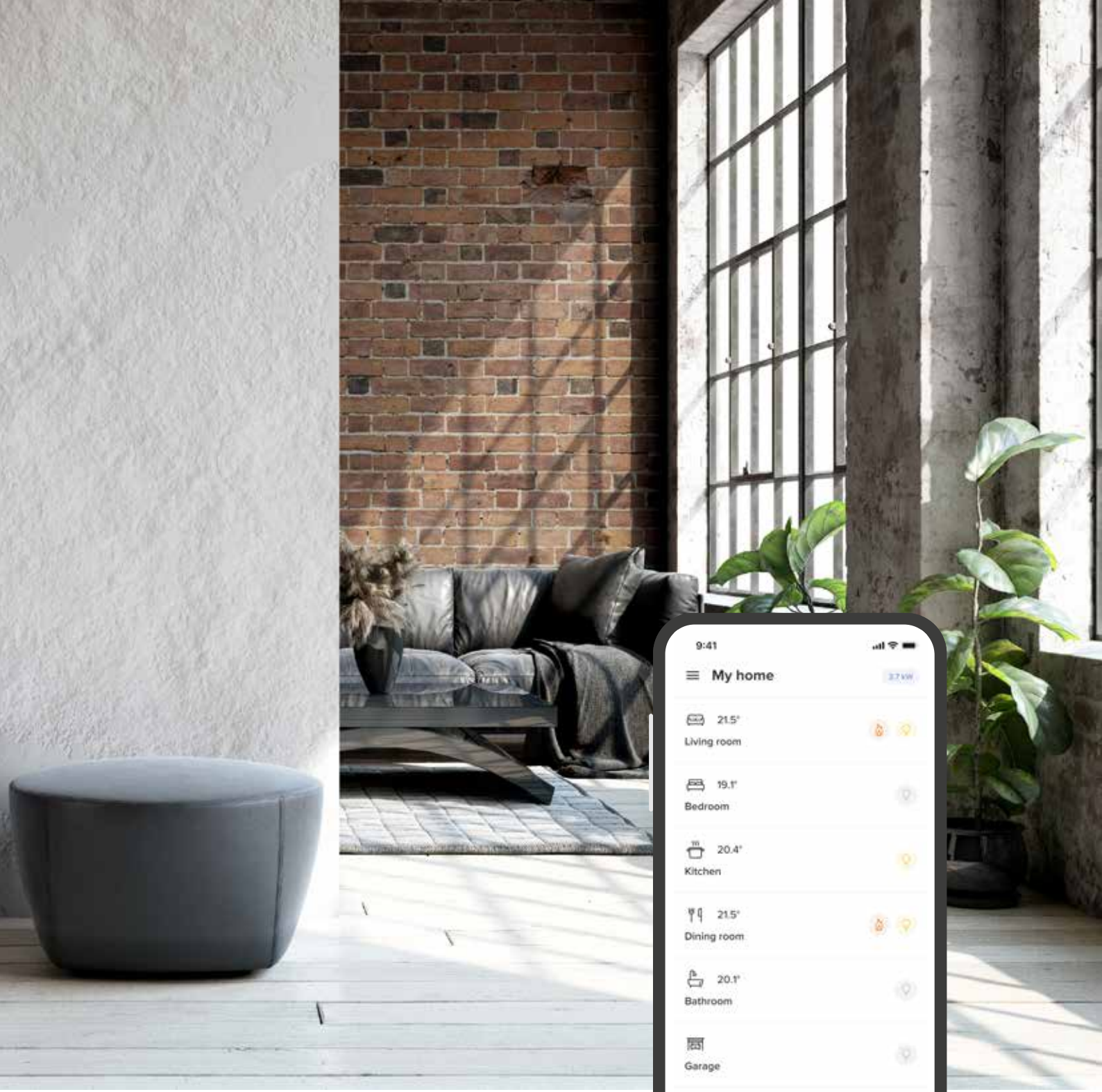

- **Yenilikçi tasarım:** mükemmel düzlemsellik ve zarif detaylar
- **Akıllı çözümler:** anahtar - priz ürün gamında ilk bağlı cihazlar!



- **Mükemmel uygulamalar** için en iyi çözümler bir arada

Yenilikçi tasarım

Mükemmel düzlemsellik ve zarif detaylar



Teknoloji ve tasarımın en iyi şekilde birleřtirilmesi ile doęan Living Now, dünyanın en prestijli ödölü olan IF Design Award' u almaya hak kazanmıştır.

Dokunarak kontrol

Aydınlatmalarınızı tuş kapağı üzerinde herhangi bir noktaya basarak açıp kapatabilirsiniz. Tuş kapağı üzerine basıp çektikten sonra tuş kapağı konumu orijinal pozisyonuna geri döner.



ANAHTARLAR





REF.	ANAHTARLAR	AMB.	AD/€	REF.	ANAHTARLAR	AMB.	AD/€				
MEKANİZMA	<input type="radio"/> K4001		Anahtar, 10AX, 250V~, Vidalı Bağlantı, Mekanizma, 1M	10	10,960	KAPAK	<input type="checkbox"/> KW01		Anahtar Grubu İçin Kapak, 1M	20	3,320
	<input type="radio"/> K4003		Vavien, 10AX, 250V~, Vidalı Bağlantı, Mekanizma, 1M	10	13,970		<input type="checkbox"/> KW01M2		Anahtar Grubu Kapak, 2M	10	5,340
	<input type="radio"/> K4005		Liht Butonu, 10A, 250V~, Vidalı Bağlantı, NA Kontak, Mekanizma, 1M	10	10,960		<input checked="" type="checkbox"/> KG01				
	<input type="radio"/> K4004		Permütatör, 10AX, 250V~, Vidalı Bağlantı, Mekanizma, 1M	10	27,180		<input type="checkbox"/> KM01				
	<input type="radio"/> K4004L		Permütatör, 10AX, 250V~, Vidalı Bağlantı, Mekanizma, 1M	10	36,470						
	<input type="radio"/> K4004LB		Permütatör, 10AX, 250V~, Vidalı Bağlantı, Mekanizma, 1M	10	36,470						

* Mekanizmalar aşağıdaki tabloda yer alan kapaklar ile tamamlanmalıdır.

REF.	KAPAK GÖRSELİ	KAPAK REFERANSLARI		
		BEYAZ	SİYAH	KUM BEJİ
K4001				
K4003		KW01	KG01	KM01
K4005				
K4004				
K4004L		KW01M2	KG01M2	KM01M2
K4004LB				

DİĞER ANAHTARLAR (DEVAM)



REF.	2 KUTUPLU ANAHTARLAR	AMB.	AD/€	REF.	2 KUTUPLU ANAHTARLAR	AMB.	AD/€
<input type="checkbox"/> KW4002	 İki Kutuplu Anahtar, 16AX, 250V-, Vidalı Bağlantı, Mekanizma, 1M	10	21,240	KAPAK <input type="checkbox"/> KW02 <input checked="" type="checkbox"/> KG02 <input type="checkbox"/> KM02	 KW4033 - KW4113 - KW4180 - K4381 için Kapak, 1M	20	3,320
<input checked="" type="checkbox"/> KG4002	 İki Kutuplu Anahtar, 16AX, 250V-, Vidalı Bağlantı, Mekanizma, 1M	10	21,240				
<input type="checkbox"/> KM4002	 İki Kutuplu Anahtar, 16AX, 250V-, Vidalı Bağlantı, Mekanizma, 1M	10	21,240				

* Mekanizmalar aşağıdaki tabloda yer alan kapaklar ile tamamlanmalıdır.

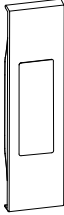
REF.	KAPAK GÖRSELİ	KAPAK REFERANSLARI		
		BEYAZ	SİYAH	KUM BEJİ
KW4002		KW02	-	-
KG4002		-	KG02	-
KM4002		-	-	KG02

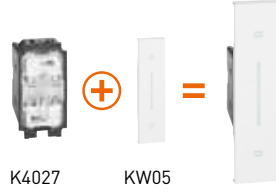
DiĞER ANAHTARLAR (DEVAM)





REF.	JALUZİ KUMANDA ANAHTARLARI	AMB.	AD/€	REF.	JALUZİ KUMANDA ANAHTARLARI	AMB.	AD/€		
MEKANİZMA	<input type="radio"/> K4027		Jaluzi Kumanda Anahtarı, 10A, 250V~, Vidalı Bağlantı, Enversör Tip (1-0-2), Mekanizma, 1M	10	31,910	<input type="checkbox"/> KW06 <input checked="" type="checkbox"/> KG06 <input type="checkbox"/> KM06	Enversör Tipi Jaluzi Kumanda Anahtarı İçin Kapak, 1M	10	3,390
	<input type="radio"/> K4037N		Mekanik Kilitlemeli Jaluzi Kumanda Anahtarı, 10A, 250V~, Vidalı Bağlantı, NA+NA Kontak, Mekanizma, 1M	10	39,490	<input type="checkbox"/> KW06V <input checked="" type="checkbox"/> KG06V <input type="checkbox"/> KM06V	Enversör Tipi Jaluzi Kumanda Anahtarı İçin Kapak, Dikey Kullanım, 1M	5	8,310
KAPAK	<input type="checkbox"/> KW06M2V <input checked="" type="checkbox"/> KG06M2V <input type="checkbox"/> KM06M2V		Enversör Tipi Jaluzi Kumanda Anahtarı İçin Kapak, Dikey Kullanım, 2M	5	12,610	<input type="checkbox"/> KW05L <input checked="" type="checkbox"/> KG05L <input type="checkbox"/> KM05L	İkili Liht Butonu İçin Kapak, 1M	5	3,320
	<input type="checkbox"/> KW05 <input checked="" type="checkbox"/> KG05 <input type="checkbox"/> KM05		Jaluzi Kumanda Anahtarı İçin Kapak, 1M	10	3,320	<input type="checkbox"/> KW05M2 <input checked="" type="checkbox"/> KG05M2 <input type="checkbox"/> KM05M2	Jaluzi Kumanda Anahtarı İçin Kapak, 2M	10	12,610
	<input type="checkbox"/> KW05V <input checked="" type="checkbox"/> KG05V <input type="checkbox"/> KM05V		Jaluzi Kumanda Anahtarı İçin Kapak, Dikey Kullanım, 1M	5	8,310	<input type="checkbox"/> KW05M2V <input checked="" type="checkbox"/> KG05M2V <input type="checkbox"/> KM05M2V	Jaluzi Kumanda Anahtarı İçin Kapak, Dikey Kullanım, 2M	5	12,610

* Mekanizmalar aşağıdaki tabloda yer alan kapaklar ile tamamlanmalıdır.

REF.	KAPAK GÖRSELİ	KAPAK REFERANSLARI		
		BEYAZ	SİYAH	KUM BEJİ
K4027		KW06	KG06	KM06
		KW06V	KG06V	KM06V
		KW06M2V	KG06M2V	KM06M2V
K4037N		KW05	KG05	KM05
		KW05M2	KG05M2	KM05M2
		KW05V	KG05V	KM05V
		KW05M2V	KG05M2V	KM05M2V

DİĞER ANAHTARLAR (DEVAM)









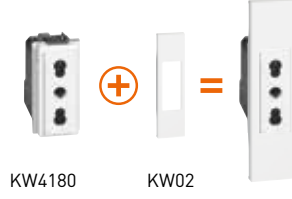

REF.	LİHT BUTONLARI	AMB.	AD/€	REF.	LİHT BUTONLARI	AMB.	AD/€
<input type="radio"/> K4034	 Liht Butonu, 10A, 250V~, Vidalı Bağlantı, NA+NK Kontak, Mekanizma, 1M	10	15,520	<input type="checkbox"/> KW01 <input checked="" type="checkbox"/> KG01 <input type="checkbox"/> KM01	 Anahtar Grubu için Kapak, 1M	20	3,320
<input type="checkbox"/> KW4033 <input checked="" type="checkbox"/> KG4033 <input type="checkbox"/> KM4033	 Liht Butonu, 10A, 250V~, Vidalı Bağlantı, NA Kontak, Kordonlu, 1M	1	25,220	<input type="checkbox"/> KW02 <input checked="" type="checkbox"/> KG02 <input type="checkbox"/> KM02	 KW4033 - KW4113 - KW4180 - K4381 için Kapak, 1M	20	3,320

* Mekanizmalar aşağıdaki tabloda yer alan kapaklar ile tamamlanmalıdır.



REF.	KAPAK GÖRSELİ	KAPAK REFERANSLARI		
		BEYAZ	SİYAH	KUM BEJİ
K4034		KW01	KG01	KM01
KW4033		KW02	-	-
KG4033		-	KG02	-
KM4033		-	-	KM02

PRİZLER

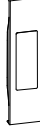

REF.	İTALYAN STANDARTI	AMB.	AD/€	REF.	İTALYAN STANDARTI	AMB.	AD/€
<input type="checkbox"/> KW4113 <input checked="" type="checkbox"/> KG4113 <input type="checkbox"/> KM4113	 İtalyan Standardı Topraklı Priz, 10A, 250V-, Vidalı Bağlantı, Çocuk Korumalı, 1M	10	7,890	<input type="checkbox"/> KW02 <input checked="" type="checkbox"/> KG02 <input type="checkbox"/> KM02 <input checked="" type="checkbox"/> KR02	 K*4033 - K*4113 - K*4180 - K4381 için Kapak, 1M	20	3,320
<input type="checkbox"/> KW4180 <input checked="" type="checkbox"/> KG4180 <input type="checkbox"/> KM4180	 İtalyan Standardı Topraklı Priz, 10/16A, 250V-, Vidalı Bağlantı, Çocuk Korumalı, 1M	10	12,410	<input type="checkbox"/> KW03 <input checked="" type="checkbox"/> KG03 <input type="checkbox"/> KM03 <input checked="" type="checkbox"/> KR03	 K*4140A16 - K*4140A16F için Kapak, 2M	20	5,100
<input type="checkbox"/> KW4140A16 <input checked="" type="checkbox"/> KG4140A16 <input type="checkbox"/> KM4140A16	 Düz Yüzeyle İtalyan/Alman Standardı Topraklı Priz, 10/16A, 250V-, Vidalı Bağlantı, Çocuk Korumalı, 2M	10	26,670	<input type="checkbox"/> KW03M3 <input checked="" type="checkbox"/> KG03M3 <input type="checkbox"/> KM03M3	 K*4140A16 - K*4140A16F için Kapak, 3M	10	6,350
<input type="checkbox"/> KW4140A16F <input checked="" type="checkbox"/> KG4140A16F <input type="checkbox"/> KM4140A16F	 Düz Yüzeyle İtalyan/Alman Standardı Topraklı Priz, 10/16A, 250V-, Vidalı Bağlantı, Çocuk Korumalı, 2M	10	26,670				

* Mekanizmalar aşağıdaki tabloda yer alan kapaklar ile tamamlanmalıdır.

REF.	KAPAK GÖRSELİ	KAPAK REFERANSLARI			
		BEYAZ	SİYAH	KUM BEJİ	KIRMIZI
KW4113		KW02	—	—	—
KG4113		—	KG02	—	—
KM4113		—	—	KM02	—
KR4113		—	—	—	KR02
KW4180		KW02	—	—	—
KG4180		—	KG02	—	—
KM4180		—	—	KM02	—
KR4180		—	—	—	KR02
KW4140A16		KW03/KW03M3	—	—	—
KG4140A16		—	KG03/KG03M3	—	—
KM4140A16		—	—	KM03/KM03M3	—
KR4140A16		—	—	—	KR03
KW4140A16F		KW03/KW03M3	—	—	—
KG4140A16F		—	KG03/KG03M3	—	—
KM4140A16F		—	—	KM03/KM03M3	—
KR4140A16F		—	—	—	KR03

PRİZLER

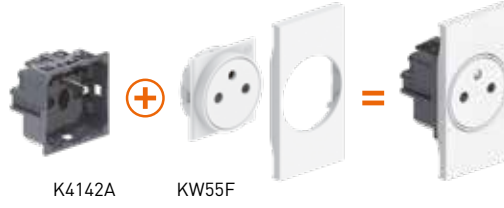

REF.	FRANSIZ STANDARDI	AMB.	AD/€	REF.	FRANSIZ STANDARDI	AMB.	AD/€
MEKANİZMA	<input type="radio"/> K4142A		Fransız Standardı Topraklı Priz, 16A, 250V~, Otomatik Bağlantı, Çocuk Korumalı, Mekanizma, 2M	10	8,790		
	<input type="checkbox"/> KW4142USB <input checked="" type="checkbox"/> KG4142USB <input type="checkbox"/> KM4142USB		Fransız Standardı Topraklı Priz, 16A, 250V~+ C Tipi USB Priz 1.5 A, Otomatik Bağlantı, Çocuk Korumalı, Mekanizma, 2M	1	48,600		
KAPAK	<input type="checkbox"/> KW55F <input checked="" type="checkbox"/> KG55F <input type="checkbox"/> KM55F <input type="checkbox"/> KR55F <input type="checkbox"/> KV55F		Düz Yüzeyle Fransız Standardı Topraklı Priz için Kapak, 2M	5	13,210		
	<input type="checkbox"/> KW55M3F <input checked="" type="checkbox"/> KG55M3F <input type="checkbox"/> KM55M3F		Düz Yüzeyle Fransız Standardı Topraklı Priz için Kapak, 3M	5	14,340		
	<input type="checkbox"/> KW55P <input checked="" type="checkbox"/> KG55P <input type="checkbox"/> KM55P		Düz Yüzeyle Fransız Standardı Topraklı Priz için Kapaklı Kapak, 2M	1	16,990		
	<input type="checkbox"/> KW62 <input checked="" type="checkbox"/> KG62 <input type="checkbox"/> KM62		K*4142USB için Kapak, 2M	5	4,480		

* Mekanizmalar aşağıdaki tabloda yer alan kapaklar ile tamamlanmalıdır.

REF.	KAPAK GÖRSELİ	KAPAK REFERANSLARI				
		BEYAZ	SİYAH	KUM BEJİ	KIRMIZI	YEŞİL
K4142A		KW55F/KW55M3F	-	-	-	-
		-	KG55F/KG55M3F	-	-	-
		-	-	KM55F/KM55M3F	-	-
		-	-	-	KR55F	-
		-	-	-	-	KV55F
SEÇİM TABLOSU	KAPAK SEÇİMİ	KW55P	-	-	-	-
		-	KG55P	-	-	-
		-	-	KM55P	-	-
KW4142USB		KW62	-	-	-	-
KG4142USB		-	KG62	-	-	-
KM4142USB		-	-	KM62	-	-

PRİZLER (DEVAM)



MEKANİZMA	REF.	AVRUPA / AMERİKA STANDARDI	AMB.	AD/€	REF.	AVRUPA / AMERİKA STANDARDI	AMB.	AD/€									
<input type="checkbox"/> KW4126 <input checked="" type="checkbox"/> KG4126 <input type="checkbox"/> KM4126		Avrupa/Amerika Standardı Priz, 16A, 127/250V~, Vidalı Bağlantı, 2M	10	11,730	<input type="checkbox"/> KW51 <input checked="" type="checkbox"/> KG51 <input type="checkbox"/> KM51		1	5,220									
									<input type="checkbox"/> KW4185 <input checked="" type="checkbox"/> KG4185 <input type="checkbox"/> KM4185		İkili Avrupa/Amerika Standardı Priz, 16A, 127/250V~, Vidalı Bağlantı, 3M	5	24,730	<input type="checkbox"/> KW52 <input checked="" type="checkbox"/> KG52 <input type="checkbox"/> KM52		10	4,180

* Mekanizmalar aşağıdaki tabloda yer alan kapaklar ile tamamlanmalıdır.

SEÇİM TABLOSU	REF.	KAPAK GÖRSELİ	KAPAK REFERANSLARI		
			BEYAZ	SİYAH	KUM BEJİ
<input type="checkbox"/> KW4126 <input checked="" type="checkbox"/> KG4126 <input type="checkbox"/> KM4126 <input type="checkbox"/> KW4185 <input checked="" type="checkbox"/> KG4185 <input type="checkbox"/> KM4185			KW51	—	—
			—	KG51	—
			—	—	KM51
			KW52	—	—
			—	KG52	—
			—	—	KM52

PRİZLER (DEVAM)



REF.	ALMAN STANDARTI	AMB.	AD/€	REF.	ALMAN STANDARTI	AMB.	AD/€
<input type="checkbox"/> KW4141TR <input type="checkbox"/> KG4141TR <input type="checkbox"/> KM4141TR <input type="checkbox"/> KR4141 <input type="checkbox"/> KV4141	Alman Standardı Topraklı Priz, 16A, 250V~, Vidalı Bağlantı, Çocuk Korumalı, 2M	10	8,480	<input type="checkbox"/> KW04 <input type="checkbox"/> KG04 <input type="checkbox"/> KM04 <input type="checkbox"/> KR04 <input type="checkbox"/> KV04	K4380 - K*4141TR için Kapak, 2M	10	4,740
<input type="checkbox"/> KW4141USB <input type="checkbox"/> KG4141USB <input type="checkbox"/> KM4141USB	Alman Standardı Topraklı Priz, 16A, 250V~+ C Tipi USB Priz 1.5 A, Otomatik Bağlantı, Çocuk Korumalı, Mekanizma, 2M	1	48,600	<input type="checkbox"/> KW04M3 <input type="checkbox"/> KG04M3 <input type="checkbox"/> KM04M3	K4380 - K*4141TR için Kapak, 3M	1	6,720
				<input type="checkbox"/> KW04P <input type="checkbox"/> KG04P <input type="checkbox"/> KM04P	K*4141TR için Kapaklı Kapak, 2M	1	7,840
				<input type="checkbox"/> KW63 <input type="checkbox"/> KG63 <input type="checkbox"/> KM63	K*4141USB için Kapak, 2M	5	6,790

* Mekanizmalar aşağıdaki tabloda yer alan kapaklar ile tamamlanmalıdır.

REF.	KAPAK GÖRSELİ	KAPAK REFERANSLARI				
		BEYAZ	SİYAH	KUM BEJİ	KIRMIZI	YEŞİL
KW4141TR		KW04/ KW04M3		-	-	-
KG4141TR		-	KG04/ KG04M3	-	-	-
KM4141TR		-	-	KM04/ KM04M3	-	-
KR4141		-	-	-	KR04	-
KV4141		-	-	-	-	KV04
KW4141TR		KW04P		-	-	-
KG4141TR		-	KG04P	-	-	-
KM4141TR		-	-	KM04P	-	-
KW4141USB		KW63		-	-	-
KG4141USB		-	KG63	-	-	-
KM4141USB		-	-	KM63	-	-

TV PRİZLER











REF.	TV PRİZLERİ	AMB.	AD/€	REF.	TV PRİZLERİ	AMB.	AD/€
○ K4202D	TV Prizi, Yıldız Bağlantı, Mekanizma, 1M	1	32,500	<input type="checkbox"/> KW08 <input checked="" type="checkbox"/> KG08 <input type="checkbox"/> KM08	TV Prizi ve Kablo Çıkış Modülü İçin Kapak, 1M	10	6,660
○ K4202P14	TV Prizi, 14 dB, Geçişli, Mekanizma, 1M	1	47,340	<input type="checkbox"/> KW09 <input checked="" type="checkbox"/> KG09 <input type="checkbox"/> KM09	TV-SAT Prizi İçin Kapak, 1M	10	6,660
○ K4202P10	TV Prizi, 10 dB, Sonlu, Mekanizma, 1M	1	47,340	<input type="checkbox"/> KW08M2 <input checked="" type="checkbox"/> KG08M2 <input type="checkbox"/> KM08M2	TV Prizi için Kapak, 2M	10	7,880
○ K4202F	TV Prizi, F Tipi, Mekanizma, 1M	1	18,720	<input type="checkbox"/> KW25M2 <input checked="" type="checkbox"/> KG25M2 <input type="checkbox"/> KM25M2	İki Delikli TV Priz Kapağı, 2M	10	4,480
○ K4214D	TV-SAT Prizi, Mekanizma, 1M	1	48,310	<input type="checkbox"/> KW26M2 <input checked="" type="checkbox"/> KG26M2 <input type="checkbox"/> KM26M2	TV-R-SAT Prizi İçin Kapak, 2M	10	5,000
○ K4211M2C	TV-Radyo Priz, Mekanizma, 2M	1	46,760				
○ K4210M2D	TV-R-SAT Prizi, 2M	1	46,760				



* Mekanizmalar aşağıdaki tabloda yer alan kapaklar ile tamamlanmalıdır.

REF.	KAPAK GÖRSELİ	KAPAK REFERANSLARI		
		BEYAZ	SIYAH	KUM BEJİ
K4202D		KW08	KG08	KM08
K4202P14				
K4202P10				
K4202F		KW08M2	KG08M2	KM08M2
KW08M2				
K4214D				
K4211M2C				
K4210M2D		KW26M2	KW26M2	KW26M2

DATA VE TELEFON PRİZLER



REF.	DATA VE TELEFON PRİZLER	AMB.	AD/€	REF.	DATA VE TELEFON PRİZLER	AMB.	AD/€
<input type="checkbox"/> KW4279C5E <input checked="" type="checkbox"/> KG4279C5E <input type="checkbox"/> KM4279C5E	 Data Prizi, CAT5e UTP, Aletsiz, 1M	10	9,410	<input type="checkbox"/> KW07 <input checked="" type="checkbox"/> KG07 <input type="checkbox"/> KM07	 Data, Telefon ve Audio/Video Prizleri İçin Kapak, 1M	10	6,360
<input type="checkbox"/> KW4279C6 <input checked="" type="checkbox"/> KG4279C6 <input type="checkbox"/> KM4279C6	 Data Prizi, CAT6 UTP, Aletsiz, 1M	10	14,840	<input type="checkbox"/> KW07M2 <input checked="" type="checkbox"/> KG07M2 <input type="checkbox"/> KM07M2	 Data, Telefon ve Audio/Video Prizleri İçin Kapak, 2M	10	6,360
<input type="checkbox"/> KW4279C6S <input checked="" type="checkbox"/> KG4279C6S <input type="checkbox"/> KM4279C6S	 Data Prizi, CAT6 STP, Aletsiz, 1M	1	20,370				
<input type="checkbox"/> KW4279C6A <input checked="" type="checkbox"/> KG4279C6A <input type="checkbox"/> KM4279C6A	 Data Prizi, CAT6A UTP, Aletsiz, 1M	10	29,490				
<input type="checkbox"/> KW4279C6AS <input checked="" type="checkbox"/> KG4279C6AS <input type="checkbox"/> KM4279C6AS	 Data Prizi, CAT6A STP, Aletsiz, 1M	1	35,500				
<input type="checkbox"/> KW4258RJ11 <input checked="" type="checkbox"/> KG4258RJ11 <input type="checkbox"/> KM4258RJ11	 Telefon Prizi, RJ11, 1M	1	22,210				
<input type="checkbox"/> KW07K <input checked="" type="checkbox"/> KG07K <input type="checkbox"/> KM07K	 Data Prizi, Jacksız (Keystone), 1M	10	6,360				

REF.	KAPAK GÖRSELİ	KAPAK REFERANSLARI		
		BEYAZ	SİYAH	KUM BEJİ
KW4279C5E	 	KW07/KW07M2	—	—
KG4279C5E		—	KG07/KG07M2	—
KM4279C5E		—	—	KM07/KM07M2
KW4279C6		KW07/KW07M2	—	—
KG4279C6		—	KG07/KG07M2	—
KM4279C6		—	—	KM07/KM07M2
KW4279C6S		KW07/KW07M2	—	—
KG4279C6S		—	KG07/KG07M2	—
KM4279C6S		—	—	KM07/KM07M2
KW4279C6A		KW07/KW07M2	—	—
KG4279C6A		—	KG07/KG07M2	—
KM4279C6A		—	—	KM07/KM07M2
KW4279C6AS		KW07/KW07M2	—	—
KG4279C6AS		—	KG07/KG07M2	—
KM4279C6AS		—	—	KM07/KM07M2
KW4258RJ11		KW07/KW07M2	—	—
KG4258RJ11		—	KG07/KG07M2	—
KM4258RJ11		—	—	KM07/KM07M2





ELEKTRONİK PRİZLER



K4191A



KW11C

REF.	ELEKTRONİK PRİZLER	AMB.	AD/€	REF.	ELEKTRONİK PRİZLER	AMB.	AD/€
○ K4192C	 C tipi USB Şarj Prizi, 3A, 100-240 V-, 1M	1	36,430	<input type="checkbox"/> KW11C	USB Şarj Prizi İçin Kapak, 1M	5	6,590
○ K4191A	 A tipi USB Şarj Prizi, 3A, 100-240 V-, 1M	1	30,360	<input checked="" type="checkbox"/> KG11C		5	6,590
○ K4191AC	 A+C tipi USB Şarj Prizi, 3A, 100-240 V-, 1M	1	61,830	<input type="checkbox"/> KM11C	2xUSB Şarj Prizi İçin Kapak, 1M	5	6,660
○ K4191CC	 C+C tipi USB Şarj Prizi, 3A, 100-240 V-, 1M	1	71,130	<input type="checkbox"/> KW13C		5	6,660
○ K4191AA	 A+A tipi USB Şarj Prizi, 3A, 100-240 V-, 1M	1	54,710	<input checked="" type="checkbox"/> KG13C	5	6,660	
				<input type="checkbox"/> KM13C			6,590

MEKANİZMA

KAPAK

AUDIO VIDEO PRİZLER

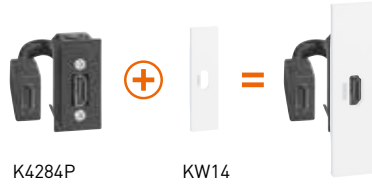

K4284P



KW14

REF.	AUDIO / VIDEO PRİZLER	AMB.	AD/€	REF.	AUDIO / VIDEO PRİZLER	AMB.	AD/€
<input type="checkbox"/> KW4269R <input checked="" type="checkbox"/> KG4269R <input type="checkbox"/> KM4269R	İki RCA Konnektör, Beyaz - Kırmızı Kontak, 1M	1	18,530	<input type="checkbox"/> KW07 <input checked="" type="checkbox"/> KG07 <input type="checkbox"/> KM07	Data, Telefon ve Audio/Video Prizleri İçin Kapak, 1M	10	6,360
<input type="checkbox"/> KW4294 <input checked="" type="checkbox"/> KG4294 <input type="checkbox"/> KM4294	Hoparlör Konnektörü, 1M	1	15,230	<input type="checkbox"/> KW14 <input checked="" type="checkbox"/> KG14 <input type="checkbox"/> KM14	HDMI Konnektör İçin Kapak, 1M	5	6,360
<input type="radio"/> K4284P	HDMI Konnektör, Mekanizma, 1M	1	49,080	<input type="checkbox"/> KW10P <input checked="" type="checkbox"/> KG10P <input type="checkbox"/> KM10P	USB Konnektör İçin Kapak, 1M	5	6,360
<input type="radio"/> K4285P	USB Konnektör, Mekanizma, 1M	1	37,750				

* Mekanizmalar aşağıdaki tabloda yer alan kapaklar ile tamamlanmalıdır.

REF.	KAPAK GÖRSELİ	KAPAK REFERANSLARI		
		BEYAZ	SİYAH	KUM BEJİ
KW4269R		KW07	—	—
KG4269R		—	KG07	—
KM4269R		—	—	KM07
KW4294		KW07	—	—
KG4294		—	KG07	—
KM4294		—	—	KM07
K4284P			KW14	KG14
K4285P		KW10P	KG10P	KM10P

DİMMERLER

REF.	DİMMERLER	AMB.	AD/€	REF.	DİMMERLER	AMB.	AD/€		
MEKANİZMA	<input type="radio"/> K4419M2 	Universal Dimmer, 240V~, Mekanizma, 2M	1	148,820	KAPAK	<input type="checkbox"/> KW01M2P	Dimmer İçin Kapak, 2M	5	7,330
	<input type="radio"/> K4410 	0-10V Dokunmatik Dimmer, 240V~, 40-600W, Mekanizma, 2M	1	148,820		<input type="checkbox"/> KW19			
					<input checked="" type="checkbox"/> KG19	Dimmer İçin Kapak, 2M	10	7,330	
					<input type="checkbox"/> KM19 				

* Mekanizmalar aşağıdaki tabloda yer alan kapaklar ile tamamlanmalıdır.

REF.	KAPAK GÖRSELİ	KAPAK REFERANSLARI			
		BEYAZ	SİYAH	KUM BEJİ	
SEÇİM TABLOSU	K4410 	KAPAK SEÇİMİ	KW19	KG19	KM19
			K4419M2	KW01M2P	KG01M2P

Not: Dimmer seçimi konusunda ayrıntılı bilgi için ürün kataloğunu inceleyiniz.







TERMOSTATLAR

KG4441

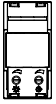
REF.	TERMOSTATLAR	AMB.	AD/€
<input type="checkbox"/> KW4441		1	161,050
<input checked="" type="checkbox"/> KG4441			
<input type="checkbox"/> KM4441			

HAREKET SENSÖRLERİ











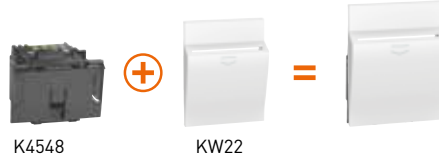

REF.	HAREKET SENSÖRLERİ	AMB.	AD/€	REF.	HAREKET SENSÖRLERİ	AMB.	AD/€			
MEKANİZMA	<input type="radio"/> K4431		PIR Hareket Sensörü, 2A, 230V~, 460W, 6m, 105°, Mekanizma, 1M	1	118,460	<input type="checkbox"/> KW16 <input checked="" type="checkbox"/> KG16 <input type="checkbox"/> KM16		Hareket Dedektörü İçin Kapak, 1M	10	6,660
	<input type="radio"/> K4432		PIR Hareket Sensörü, 1.8A, 240V~, 400W, 8m, 120°, Mekanizma, 2M	1	118,460	<input type="checkbox"/> KW17 <input checked="" type="checkbox"/> KG17 <input type="checkbox"/> KM17		Hareket Dedektörü İçin Kapak, 2M	1	9,120
	<input type="radio"/> K4430		Hareket Dedektörü, 1A, 240V~, 3-250W, 2 Kablolu, Mekanizma, 2M	1	160,950	<input type="checkbox"/> KW17SL <input checked="" type="checkbox"/> KG17SL <input type="checkbox"/> KM17SL		Hareket Dedektörü İçin Anahtar Çıkışlı Kapak, 2M	1	9,120

* Mekanizmalar aşağıdaki tabloda yer alan kapaklar ile tamamlanmalıdır.





REF.	KAPAK GÖRSELİ	KAPAK REFERANSLARI		
		BEYAZ	SİYAH	KUM BEJİ
K4431		KW16	KG16	KM16
K4432		KW17	KG17	KM17
K4430		KW17SL çalışma durum anahtarı gözükür	KG17SL çalışma durum anahtarı gözükür	KM17SL çalışma durum anahtarı gözükür

Not: Hareket sensörü seçimi konusunda ayrıntılı bilgi için ürün kataloğunu inceleyiniz.

OTEL ÇÖZÜMLERİ

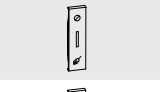
REF.	OTEL ÇÖZÜMLERİ	AMB.	AD/€	REF.	OTEL ÇÖZÜMLERİ	AMB.	AD/€
○ K4549	 Mekanik Anahtarlı Energy Saver, 230V~, Mekanizma, 2M	1	142,810	<input type="checkbox"/> KW22M2 <input checked="" type="checkbox"/> KG22M2 <input type="checkbox"/> KM22M2	 Energy Saver Kapak, 2M	5	23,180
○ K4548	 RFID Energy Saver, 230V~, Mekanizma, 2M	1	153,290	<input type="checkbox"/> KW22 <input checked="" type="checkbox"/> KG22 <input type="checkbox"/> KM22	 Energy Saver Kapak, 3M	5	27,060
○ K4027H	 Otel Çağrı Butonu, 10Ax, 250V~, DND/MUR Sembollü, Mekanizma, 1M	1	36,770	<input type="checkbox"/> KW06H <input checked="" type="checkbox"/> KG06H <input type="checkbox"/> KM06H	 Otel Çağrı Gösterge Butonu İçin Kapak, 1M	5	5,100
○ K4373	 Otel Çağrı Göstergesi, Mekanizma, 1M	1	56,630	<input type="checkbox"/> KW11H <input checked="" type="checkbox"/> KG11H <input type="checkbox"/> KM11H	 Otel Çağrı Gösterge Lambası İçin Kapak, 1M	5	5,100
<input type="checkbox"/> KW4177 <input checked="" type="checkbox"/> KG4177 <input type="checkbox"/> KM4177	 Tıraş Prizi, 230V~, 20VA, 3M	1	200,440	<input type="checkbox"/> KW02 <input checked="" type="checkbox"/> KG02 <input type="checkbox"/> KM02	 K*4362 İçin Kapak, 1M	20	3,320
<input type="checkbox"/> KW4362 <input checked="" type="checkbox"/> KG4362 <input type="checkbox"/> KM4362	 Dim edilebilir Okuma Lambası, 1M	1	192,580				

* Mekanizmalar aşağıdaki tabloda yer alan kapaklar ile tamamlanmalıdır.

REF.	KAPAK GÖRSELİ	KAPAK REFERANSLARI		
		BEYAZ	SİYAH	KUM BEJİ
K4549		KW22/KW22M2	KG22/KG22M2	KM22/KM22M2
K4548				
K4027H		KW06H	KG06H	KM06H
K4373		KW11H	KG11H	KM11H
KW4177		KAPAĞA İHTİYAÇ YOKTUR		
KG4177				
KM4177				
KW4362		KW02		
KG4362			KG02	
KM4362				KM02

İKAZ VE SİNYAL MEKANİZMALARI

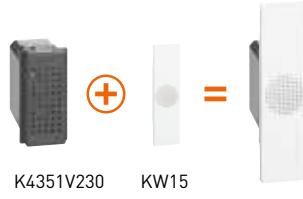

REF.	İKAZ VE SİNYAL MEKANİZMALARI	AMB.	AD/€	REF.	İKAZ VE SİNYAL MEKANİZMALARI	AMB.	AD/€
○ K4351V230	Zil, 230V~, 12VA, 80 dB, Mekanizma, 1M	10	55,000	<input type="checkbox"/> KW15	Zil/Buzzer için Kapak, 1M	10	6,660
○ K4351V12	Zil, 12V~, Mekanizma, 1M	10	55,000	<input checked="" type="checkbox"/> KG15			
				<input type="checkbox"/> KM15			
○ K4355V12	Elektronik Zil, 12V~/12VDC, 2M	1	142,810	<input type="checkbox"/> KW15M2	Elektronik Zil için Kapak, 2M	10	6,660
				<input checked="" type="checkbox"/> KG15M2			
				<input type="checkbox"/> KM15M2			
○ K4356V230	Buzzer, 230V~, 12VA, 80 dB, Mekanizma, 1M	10	42,780	<input type="checkbox"/> KW04	K4380 - KW4141TR için Kapak, 2M	10	4,740
				<input checked="" type="checkbox"/> KG04			
				<input type="checkbox"/> KM04			
○ K4356V12	Zil, 12V~, Mekanizma, 1M	10	42,780	<input type="checkbox"/> KW02	KW4033 - KW4113 - KW4180 - K4381 için Kapak, 1M	20	3,320
				<input checked="" type="checkbox"/> KG02			
				<input type="checkbox"/> KM02			
○ K4380	Taşınabilir Lamba, 230V~, Mekanizma, 2M	1	121,460	<input type="checkbox"/> KW08	K4371 için Kapak, Tek Lamba Kullanımı için, 1M	10	6,660
				<input checked="" type="checkbox"/> KG08			
				<input type="checkbox"/> KM08			
○ 4380NB	K4380N için Batarya	1	11,810	<input type="checkbox"/> KW09	K4371 için Kapak, İki Lamba Kullanımı için, 1M	10	6,660
				<input checked="" type="checkbox"/> KG09			
				<input type="checkbox"/> KM09			
○ K4381	Acil Aydınlatma Lambası, 230V~, 5VA, Mekanizma, 1M	1	109,340	<input type="checkbox"/> KW71	Merdiven Basamağı Aydınlatması için Kapak, 2M	5	11,540
				<input checked="" type="checkbox"/> KG71			
				<input type="checkbox"/> KM71			
○ K4371	Sinyal Lambası, LED ile donatılabilir, 1M	1	11,540				
○ K4382	Merdiven Basamağı Aydınlatması, 127/230V AC, 2M	10	76,640				

* Mekanizmalar aşağıdaki tabloda yer alan kapaklar ile tamamlanmalıdır.

REF.	KAPAK GÖRSELİ	KAPAK REFERANSLARI		
		BEYAZ	SİYAH	KUM BEJİ
K4351V230		KW15	KG15	KM15
K4351V12		KW15M2	KG15M2	KM15M2
K4355V12		KW15	KG15	KM15
K4356V230		KW08/KW09	—	—
K4356V12		—	KG08/KG09	—
K4371		—	—	KM08/KM09
K4382		KW71	—	—
		—	KG71	—
		—	—	KM71

LED LAMBALAR

K4743V230T



LN4743/230T



H4743/12B



LN4743/12T



H4743/230B



K4743V230RG

REF.	LED LAMBALAR	AMB.	AD/€
○ K4743V230T	Yüksek Işıklı Beyaz LED Lamba, 230V~	10	9,700
○ LN4743/230T	Beyaz LED Lamba, 230V~	10	3,600
○ LN4743/12T	Beyaz LED Lamba, 12V~	10	3,600
○ H4743/230B	Mavi LED Lamba, 230V~	10	3,520
○ H4743/12B	Mavi LED Lamba, 12V~	10	3,520
○ K4743V230RG	Kırmızı/Yeşil LED Lamba, 230V~	10	10,570

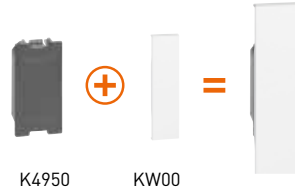
BOŞLUK KAPAKLARI

REF.	BOŞLUK KAPAKLARI	AMB.	AD/€	REF.	BOŞLUK KAPAKLARI	AMB.	AD/€
○ K4949	Boşluk Kapağı, Mekanizma, 0,5M	10	1,210	<input type="checkbox"/> KW00 <input checked="" type="checkbox"/> KG00 <input type="checkbox"/> KM00	Boşluk Kapağı, 1M	20	3,320
○ K4950	Boşluk Kapağı, Mekanizma, 1M	10	0,530	<input type="checkbox"/> KW00M2 <input checked="" type="checkbox"/> KG00M2 <input type="checkbox"/> KM00M2	Boşluk Kapağı, 2M	20	4,900
○ K4953	Kablo Çıkış Kapağı, Mekanizma, 1M	1	4,370	<input type="checkbox"/> KW08 <input checked="" type="checkbox"/> KG08 <input type="checkbox"/> KM08	TV Prizi ve Kablo Çıkış Modülü İçin Kapak, 1M	10	6,660

* Mekanizmalar aşağıdaki tabloda yer alan kapaklar ile tamamlanmalıdır.

REF.	KAPAK GÖRSELİ	KAPAK REFERANSLARI		
		BEYAZ	SİYAH	KUM BEJİ
K4949	—	KAPAĞA İHTİYAÇ YOKTUR		
K4950		KW00/KW00M2	KG00/KG00M2	KM00/KM00M2
K4953		KW08	KG08	KM08

SEMBOLLÜ TUŞ KAPAKLARI



KW01PN

KG01RN

KM01SN

KW01M2PN

KG01M2RN

KG01M2RN



KW01X

KG01A

KM01D

KW01F

KW01M2X

KG01M2A

KM01M2D

KW01M2F

REF.	SEMBOLLÜ TUŞ KAPAKLARI	AMB.	AD/€
<input type="checkbox"/> KW01PN <input checked="" type="checkbox"/> KG01PN <input type="checkbox"/> KM01PN	Isıtma Sembollü Tuş Kapağı, 1M	5	7,700
<input type="checkbox"/> KW01RN <input checked="" type="checkbox"/> KG01RN <input type="checkbox"/> KM01RN	Fan Sembollü Tuş Kapağı, 1M	5	7,700
<input type="checkbox"/> KW01SN <input checked="" type="checkbox"/> KG01SN <input type="checkbox"/> KM01SN	Boiler Sembollü Tuş Kapağı, 1M	5	7,700
<input type="checkbox"/> KW01X <input checked="" type="checkbox"/> KG01X <input type="checkbox"/> KM01X	Şeffaf Pencerele Tuş Kapağı, 1M	5	4,990
<input type="checkbox"/> KW01A <input checked="" type="checkbox"/> KG01A <input type="checkbox"/> KM01A	Lamba Sembollü Tuş Kapağı, 1M	10	4,990
<input type="checkbox"/> KW01D <input checked="" type="checkbox"/> KG01D <input type="checkbox"/> KM01D	Zil Sembollü Tuş Kapağı, 1M	10	4,990
<input type="checkbox"/> KW01F <input checked="" type="checkbox"/> KG01F <input type="checkbox"/> KM01F	Anahtar Sembollü Tuş Kapağı, 1M	10	4,990

REF.	SEMBOLLÜ TUŞ KAPAKLARI	AMB.	AD/€
<input type="checkbox"/> KW01M2PN <input checked="" type="checkbox"/> KG01M2PN <input type="checkbox"/> KM01M2PN	Isıtma Sembollü Tuş Kapağı, 2M	5	9,810
<input type="checkbox"/> KW01M2RN <input checked="" type="checkbox"/> KG01M2RN <input type="checkbox"/> KM01M2RN	Fan Sembollü Tuş Kapağı, 2M	5	9,810
<input type="checkbox"/> KW01M2SN <input checked="" type="checkbox"/> KG01M2SN <input type="checkbox"/> KM01M2SN	Boiler Sembollü Tuş Kapağı, 2M	5	9,810
<input type="checkbox"/> KW01M2X <input checked="" type="checkbox"/> KG01M2X <input type="checkbox"/> KM01M2X	Şeffaf Pencerele Tuş Kapağı, 2M	5	6,630
<input type="checkbox"/> KW01M2A <input checked="" type="checkbox"/> KG01M2A <input type="checkbox"/> KM01M2A	Lamba Sembollü Tuş Kapağı, 2M	10	6,630
<input type="checkbox"/> KW01M2D <input checked="" type="checkbox"/> KG01M2D <input type="checkbox"/> KM01M2D	Zil Sembollü Tuş Kapağı, 2M	5	6,630
<input type="checkbox"/> KW01M2F <input checked="" type="checkbox"/> KG01M2F <input type="checkbox"/> KM01M2F	Anahtar Sembollü Tuş Kapağı, 2M	5	6,630

KAİDELER



K4702



K4704

REF.	KAİDELER	AMB.	AD/€
<input type="radio"/> K4702	 Plastik Kaide, Vidalı, 2M	10	3,020
<input type="radio"/> K4703	 Plastik Kaide, 3M	10	3,020
<input type="radio"/> K4704	 Plastik Kaide, 4M	5	6,660
<input type="radio"/> K4706	 Plastik Kaide, 6M	1	13,970

POLİMER PLASTİK ÇERÇEVELER

REF.	POLİMER PLASTİK ÇERÇEVELER	AMB.	AD/€	REF.	POLİMER PLASTİK ÇERÇEVELER	AMB.	AD/€
KA4802KW	Çerçeve, Beyaz, 2M	1	8,350	KA4802DM	Çerçeve, Atmosfer, 2M	1	12,700
KA4802M2KW	Çerçeve, 2+2M, Beyaz	1	14,060	KA4802M2DM	Çerçeve, 2+2M, Atmosfer	1	20,950
KA4802M3KW	Çerçeve, 2+2+2M, Beyaz	1	19,880	KA4802M3DM	Çerçeve, 2+2+2M, Atmosfer	1	29,880
KA4802M4KW	Çerçeve, 2+2+2+2M, Beyaz	1	25,800	KA4802M4DM	Çerçeve, 2+2+2+2M, Atmosfer	1	38,900
KA4803KW	Çerçeve, Beyaz, 3M	1	8,350	KA4803DM	Çerçeve, Atmosfer, 3M	1	12,700
KA4804KW	Çerçeve, Beyaz, 4M	1	11,060	KA4804DM	Çerçeve, Atmosfer, 4M	1	17,170
KA4806KW	Çerçeve, Beyaz, 6M	1	16,970	KA4806DM	Çerçeve, Atmosfer, 6M	1	26,380
KA4802KG	Çerçeve, Siyah, 2M	1	8,350	KA4802DA	Çerçeve, Gökyüzü, 2M	1	12,700
KA4802M2KG	Çerçeve, 2+2M, Siyah	1	14,060	KA4802M2DA	Çerçeve, 2+2M, Gökyüzü	1	20,950
KA4802M3KG	Çerçeve, 2+2+2M, Siyah	1	19,880	KA4802M3DA	Çerçeve, 2+2+2M, Gökyüzü	1	29,880
KA4802M4KG	Çerçeve, 2+2+2+2M, Siyah	1	25,800	KA4802M4DA	Çerçeve, 2+2+2+2M, Gökyüzü	1	38,900
KA4803KG	Çerçeve, Siyah, 3M	1	8,350	KA4803DA	Çerçeve, Gökyüzü, 3M	1	12,700
KA4804KG	Çerçeve, Siyah, 4M	1	11,060	KA4804DA	Çerçeve, Gökyüzü, 4M	1	17,170
KA4806KG	Çerçeve, Siyah, 6M	1	16,970	KA4806DA	Çerçeve, Gökyüzü, 6M	1	26,380
KA4802KM	Çerçeve, Kum Beji, 2M	1	8,350	KA4802MM	Çerçeve, Optik, 2M	1	19,980
KA4802M2KM	Çerçeve, 2+2M, Kum Beji	1	14,060	KA4802M2MM	Çerçeve, 2+2M, Optik	1	32,010
KA4802M3KM	Çerçeve, 2+2+2M, Kum Beji	1	19,880	KA4802M3MM	Çerçeve, 2+2+2M, Optik	1	45,980
KA4802M4KM	Çerçeve, 2+2+2+2M, Kum Beji	1	25,800	KA4802M4MM	Çerçeve, 2+2+2+2M, Optik	1	59,470
KA4803KM	Çerçeve, Kum Beji, 3M	1	8,350	KA4803MM	Çerçeve, Optik, 3M	1	19,980
KA4804KM	Çerçeve, Kum Beji, 4M	1	11,060	KA4804MM	Çerçeve, Optik, 4M	1	27,060
KA4806KM	Çerçeve, Kum Beji, 6M	1	16,970	KA4806MM	Çerçeve, Optik, 6M	1	41,620
KA4802DW	Çerçeve, Buz, 2M	1	12,700	KA4802MW	Çerçeve, Piksel, 2M	1	19,980
KA4802M2DW	Çerçeve, 2+2M, Buz	1	20,950	KA4802M2MW	Çerçeve, 2+2M, Piksel	1	32,010
KA4802M3DW	Çerçeve, 2+2+2M, Buz	1	29,880	KA4802M3MW	Çerçeve, 2+2+2M, Piksel	1	45,980
KA4802M4DW	Çerçeve, 2+2+2+2M, Buz	1	38,900	KA4802M4MW	Çerçeve, 2+2+2+2M, Piksel	1	59,470
KA4803DW	Çerçeve, Buz, 3M	1	12,700	KA4803MW	Çerçeve, Piksel, 3M	1	19,980
KA4804DW	Çerçeve, Buz, 4M	1	17,170	KA4804MW	Çerçeve, Piksel, 4M	1	27,060
KA4806DW	Çerçeve, Buz, 6M	1	26,380	KA4806MW	Çerçeve, Piksel, 6M	1	41,620
KA4802DG	Çerçeve, Gece, 2M	1	12,700				
KA4802M2DG	Çerçeve, 2+2M, Gece	1	20,950				
KA4802M3DG	Çerçeve, 2+2+2M, Gece	1	29,880				
KA4802M4DG	Çerçeve, 2+2+2+2M, Gece	1	38,900				
KA4803DG	Çerçeve, Gece, 3M	1	12,700				
KA4804DG	Çerçeve, Gece, 4M	1	17,170				
KA4806DG	Çerçeve, Gece, 6M	1	26,380				

METAL ÇERÇEVELER
AHŞAP ÇERÇEVELER

REF.	METAL ÇERÇEVELER	AMB.	AD/€	REF.	AHŞAP ÇERÇEVELER	AMB.	AD/€
KA4802M2NW	Çerçeve, Ayışığı, 2M	1	31,270	KA4802LG	Çerçeve, Ceviz, 2M	1	62,290
KA4802M3NW	Çerçeve, 2+2M, Ay Işığı	1	51,030	KA4802M2LG	Çerçeve, 2+2M, Ceviz	1	90,610
KA4802M4NW	Çerçeve, 2+2+2M, Ay Işığı	1	73,040	KA4802M3LG	Çerçeve, 2+2+2M, Ceviz	1	124,590
KA4803NW	Çerçeve, 2+2+2+2M, Ay Işığı	1	95,040	KA4802M4LG	Çerçeve, 2+2+2+2M, Ceviz	1	158,580
KA4804NW	Çerçeve, Ayışığı, 3M	1	31,270	KA4803LG	Çerçeve, Ceviz, 3M	1	68,710
KA4806NW	Çerçeve, Ayışığı, 4M	1	42,070	KA4804LG	Çerçeve, Ceviz, 4M	1	74,380
KA4802NG	Çerçeve, Ayışığı, 6M	1	65,400	KA4806LG	Çerçeve, Ceviz, 6M	1	102,930
KA4802M2NG	Çerçeve, Sis, 2M	1	31,270	KA4802LM	Çerçeve, Meşe, 2M	1	62,290
KA4802M3NG	Çerçeve, 2+2M, Sis	1	51,030	KA4802M2LM	Çerçeve, 2+2M, Meşe	1	90,610
KA4802M4NG	Çerçeve, 2+2+2M, Sis	1	73,040	KA4802M3LM	Çerçeve, 2+2+2M, Meşe	1	124,590
KA4803NG	Çerçeve, 2+2+2+2M, Sis	1	95,040	KA4802M4LM	Çerçeve, 2+2+2+2M, Meşe	1	158,580
KA4804NG	Çerçeve, Sis, 3M	1	31,270	KA4803LM	Çerçeve, Meşe, 3M	1	68,710
KA4806NG	Çerçeve, Sis, 4M	1	42,070	KA4804LM	Çerçeve, Meşe, 4M	1	74,380
KA4802ZG	Çerçeve, Sis, 6M	1	65,400	KA4806LM	Çerçeve, Meşe, 6M	1	102,930
KA4802M2ZG	Çerçeve, Çelik, 2M	1	31,270				
KA4802M3ZG	Çerçeve, 2+2M, Çelik	1	51,030				
KA4802M4ZG	Çerçeve, 2+2+2M, Çelik	1	73,040				
KA4803ZG	Çerçeve, 2+2+2+2M, Çelik	1	95,040				
KA4804ZG	Çerçeve, Çelik, 3M	1	31,270				
KA4806ZG	Çerçeve, Çelik, 4M	1	42,070				
KA4802ZM	Çerçeve, Çelik, 6M	1	65,400				
KA4802M2ZM	Çerçeve, Bakır, 2M	1	31,270				
KA4802M3ZM	Çerçeve, 2+2M, Bakır	1	51,030				
KA4802M4ZM	Çerçeve, 2+2+2M, Bakır	1	73,040				
KA4803ZM	Çerçeve, 2+2+2+2M, Bakır	1	95,040				
KA4804ZM	Çerçeve, Bakır, 3M	1	31,270				
KA4806ZM	Çerçeve, Bakır, 4M	1	42,070				
KA4802ZW	Çerçeve, Bakır, 6M	1	65,400				
KA4802M2ZW	Çerçeve, Altın, 2M	1	31,270				
KA4802M3ZW	Çerçeve, 2+2M, Altın	1	51,030				
KA4802M4ZW	Çerçeve, 2+2+2M, Altın	1	73,040				
KA4803ZW	Çerçeve, 2+2+2+2M, Altın	1	95,040				
KA4804ZW	Çerçeve, Altın, 3M	1	31,270				
KA4806ZW	Çerçeve, Altın, 4M	1	42,070				
KA4806ZW	Çerçeve, Altın, 6M	1	65,400				



- Yenilikçi tasarım: mükemmel düzlemsellik ve zarif detaylar.
- Akıllı Çözümler: anahtar-priz ürün gamında ilk bağlı cihazlar!
- Mükemmel uygulamalar için en iyi çözümler bir arada



Home + Control

Living Now ^{WITH} Netatmo

AKILLI ELEKTRİK SİSTEMİ

Evinizi, e-mail hesabınızı ya da banka hesabınızı kontrol eder gibi kontrol edin. Tüm bu kontroller tamamen güvenli ve kolay kullanım ile parmağınızın ucunda.



HOME + CONTROL

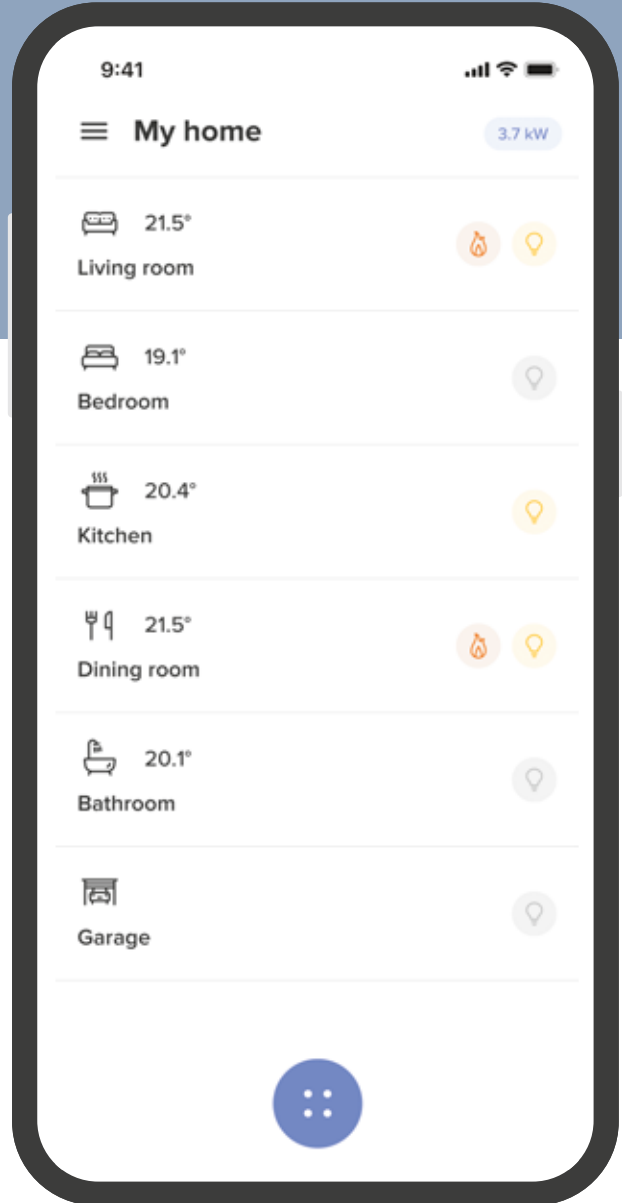

GENEL KONTROL

Sadece tek bir tıkla evden çıkacağınız zaman tüm ışıkları kapatabilir ve panjurları indirebilirsiniz ya da isterseniz daha önceden belirlediğiniz senaryonuzu çalıştırabilirsiniz.



AKILLI TELEFON İLE KONTROL

Akıllı telefonunuzdan nerede olursanız olun aydınlatma, perde-panjur, priz gibi cihazların durumlarını görebilir ya da kontrol edebilirsiniz.



SESLİ KOMUT

Sisteminizi sesli asistanız ile kontrol edebilirsiniz.

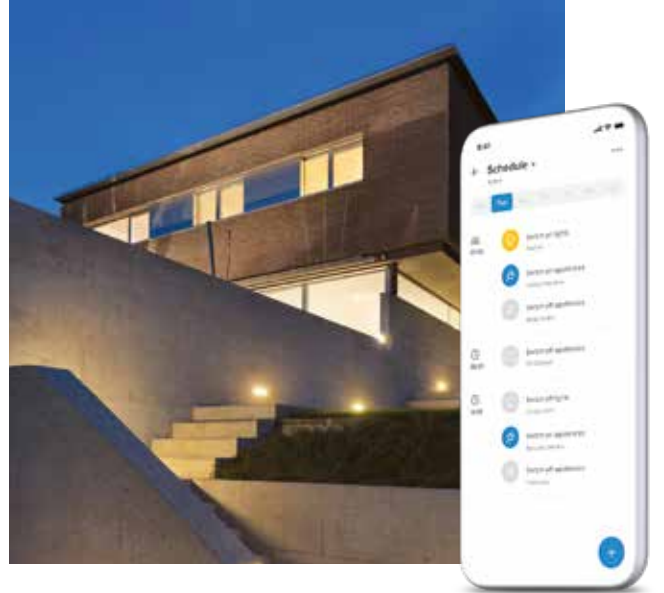

PLANLANABİLİR PROGRAMLAR

İhtiyaçlarınıza göre aydınlatmaların, perde panjurların ve bağlı prizlere bağlı yüklerin aktivasyonunu programlayınız.

Örneğin:

- Gün batımında bahçe aydınlatmalarının otomatik olarak açılması, gün doğumunda kapanması
- Tatiliniz sırasında güvenliğinizi için evdeymiş gibi bazı aydınlatmaları ve perde/panjurları aktif edin

BAĞLI AYDINLATMA KONTROL CİHAZLARI

REF.	BAĞLI AYDINLATMA KONTROL CİHAZLARI	AMB.	AD/€	REF.	KAPAKLAR	AMB.	AD/€			
MEKANİZMA	<input type="radio"/> K4001C	Bağlı Anahtar, 1M	1	74,00	KAPAK	<input type="checkbox"/> KW01 <input checked="" type="checkbox"/> KG01 <input type="checkbox"/> KM01		K4001C, K4003C ve K4411C için Kapak, 1M	20	3,32
	<input type="radio"/> K4003C	Bağlı Vavien Anahtar, 1M	1	74,00		<input type="checkbox"/> KW01M2 <input checked="" type="checkbox"/> KG01M2 <input type="checkbox"/> KM01M2		K4001C, K4003C ve K4411C için Kapak, 2M	10	5,34
	<input type="radio"/> 3584C	Bağlı Aydınlatma Kontrol Rölesi	1	88,00		<input type="checkbox"/> KW33M2 <input checked="" type="checkbox"/> KG33M2 <input type="checkbox"/> KM33M2		K4413CM2 için Kapak, 2M	20	6,00
	<input type="radio"/> 412170	Aydınlatma için Bağlı DIN Rölesi, 1M DIN	1	133,00						
REF.	BAĞLI DİMMER/ANAHTAR	AMB.	AD/€							
MEKANİZMA	<input type="radio"/> K4411C	Bağlı Universal Dimmer/Anahtar, 1M	1	84,00						
	<input type="radio"/> K4413CM2	Bağlı Nötrsüz Dimmer/Anahtar, 2M	1	125,00						
	<input type="radio"/> 4411C	Bağlı Dimmer	1	138,00						

* Mekanizmalar aşağıdaki tabloda yer alan kapaklar ile tamamlanmalıdır.

REF.	KAPAK GÖRSELİ	KAPAK REFERANSLARI		
		BEYAZ	SİYAH	KUM BEJİ
K4001C		KW01/KW01M2	KG01/KG01M2	KM01/KM01M2
K4003C		KW01/KW01M2	KG01/KG01M2	KM01/KM01M2
K4411C		KW01/KW01M2	KG01/KG01M2	KM01/KM01M2
K4413CM2		KW33M2	KG33M2	KM33M2

KABLOSUZ AYDINLATMA KONTROL CİHAZLARI



REF.	KABLOSUZ AYDINLATMA KONTROL CİHAZLARI	AMB.	AD/€	REF.	KAPAKLAR	AMB.	AD/€				
MEKANİZMA	<input type="radio"/> K4003CWI		Kablosuz Aydınlatma Kontrol Cihazı, 1M	1	100,00	KAPAK	<input type="checkbox"/> KW01 <input checked="" type="checkbox"/> KG01 <input type="checkbox"/> KM01		K4003CWI için Kapak, 1M	20	3,32
	<input type="radio"/> K4003CW		Kablosuz Aydınlatma Kontrol Cihazı, 2M	1	91,00		<input type="checkbox"/> KW42M2 <input checked="" type="checkbox"/> KG42M2 <input type="checkbox"/> KM42M2		K4003CW için Kapak, 2M	5	6,00
	<input type="radio"/> K4003DCW		Kablosuz İkili Aydınlatma Kontrol Cihazı, 2M	1	135,00		<input type="checkbox"/> KW36M2 <input checked="" type="checkbox"/> KG36M2 <input type="checkbox"/> KM36M2		K4003DCW için Kapak, 1+1M	5	8,00
	<input type="radio"/> 3577C		Mekanik Anahtarlar için Kablosuz Modül	1	91,00						

* Mekanizmalar aşağıdaki tabloda yer alan kapaklar ile tamamlanmalıdır.

REF.	KAPAK GÖRSELİ	KAPAK REFERANSLARI			
		BEYAZ	SİYAH	KUM BEJİ	
SEÇİM TABLOSU	KAPAK SEÇİMİ		KW01	KG01	KM01
			KW42M2	KG42M2	KM42M2
			KW36M2	KG36M2	KM36M2

KABLOSUZ HAREKET SENSÖRÜ



3585C

REF.	KABLOSUZ HAREKET SENSÖRÜ	AMB.	AD/€
<input type="checkbox"/> 3585C		Kablosuz Hareket Sensörü	1 166,00

BAĞLI PERDE/PANJUR KONTROL CİHAZLARI





REF.	BAĞLI PERDE/PANJUR KONTROL CİHAZLARI	AMB.	AD/€	REF.	KAPAKLAR	AMB.	AD/€				
MEKANİZMA	<input type="radio"/> K4027C		Bağlı Perde/Panjur Kontrol Cihazı, 1M	1	102,00	<input type="checkbox"/> KW32 <input checked="" type="checkbox"/> KG32 <input type="checkbox"/> KM32		K4027C ve K4027CIL için Kapak, 1M	10	4,00	
	<input type="radio"/> K4027CIL		Bağlı Mekanik Kilitli Perde/Panjur Kontrol Cihazı, 1M	1	102,00		<input type="checkbox"/> KW32M2 <input checked="" type="checkbox"/> KG32M2 <input type="checkbox"/> KM32M2		K4027C, K4027CIL ve K4027CM2 için Kapak, 2M	10	6,00
	<input type="radio"/> K4027CM2		Bağlı Perde/Panjur Kontrol Cihazı, 2M	1	135,00						
	<input type="radio"/> 4027C		Bağlı Perde/Panjur Kontrol Modülü	1	163,00						
	<input type="radio"/> 3586C		Bağlı Garaj /Kapı Modülü	1	200,00						

* Mekanizmalar aşağıdaki tabloda yer alan kapaklar ile tamamlanmalıdır.

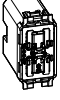

REF.	KAPAK GÖRSELİ	KAPAK REFERANSLARI			
		BEYAZ	SİYAH	KUM BEJİ	
SEÇİM TABLOSU		K4027C	KW32/KW32M2	KG32/KG32M2	KM32/KM32M2
		K4027CIL	KW32/KW32M2	KG32/KG32M2	KM32/KM32M2
	K4027CM2		KW32M2	KW32M2	KW32M2

KABLOSUZ PERDE/PANJUR KONTROL CİHAZLARI









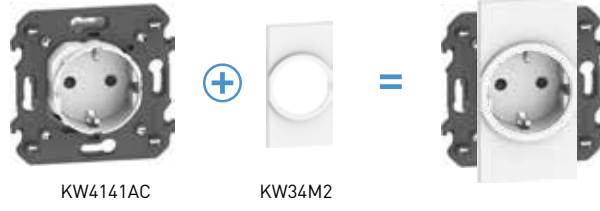

REF.	KABLOSUZ PERDE/PANJUR KONTROL CİHAZLARI	AMB.	AD/€	REF.	KAPAKLAR	AMB.	AD/€				
MEKANİZMA	<input type="radio"/> K4027CWI		Kablosuz Perde/Panjur Kontrol Cihazı, 1M	1	100,00	KAPAK	<input type="checkbox"/> KW32 <input checked="" type="checkbox"/> KG32 <input type="checkbox"/> KM32		K4027CWI için Kapak, 1M	10	4,00
	<input type="radio"/> K4027CW		Kablosuz Perde/Panjur Kontrol Cihazı, 2M	1	110,00		<input type="checkbox"/> KW43M2 <input checked="" type="checkbox"/> KG43M2 <input type="checkbox"/> KM43M2		K4027CW için Kapak, 2M	5	6,00



* Mekanizmalar aşağıdaki tabloda yer alan kapaklar ile tamamlanmalıdır.

REF.	KAPAK GÖRSELİ	KAPAK REFERANSLARI			
		BEYAZ	SİYAH	KUM BEJİ	
SEÇİM TABLOSU	KAPAK SEÇİMİ		KW32	KG32	KM32
			KW43M2	KG43M2	KM43M2



BAĞLI ENERJİ YÖNETİMİ CİHAZLARI

REF.	BAĞLI ENERJİ YÖNETİMİ CİHAZLARI	AMB.	AD/€	REF.	KAPAKLAR	AMB.	AD/€
<input type="radio"/> K4531C	 Bağlı Priz Modülü, 1M	1	74,00	<input type="checkbox"/> KW31 <input checked="" type="checkbox"/> KG31 <input type="checkbox"/> KM31	 K4531C için Kapak, 1M	10	4,00
<input type="checkbox"/> KW4141AC <input checked="" type="checkbox"/> KG4141AC <input type="checkbox"/> KM4141AC	 Bağlı Alman Tipi Çocuk Korumalı Topraklı Priz, Monoblok, 2M	1	106,00	<input type="checkbox"/> KW34M2 <input checked="" type="checkbox"/> KG34M2 <input type="checkbox"/> KM34M2	 K*4141AC için Kapak, 2M	5	6,00
<input type="checkbox"/> KW4142AC <input checked="" type="checkbox"/> KG4142AC <input type="checkbox"/> KM4142AC	 Bağlı Fransız Tipi Çocuk Korumalı Topraklı Priz, Monoblok, 2M	1	106,00	<input type="checkbox"/> KW35M2 <input checked="" type="checkbox"/> KG35M2 <input type="checkbox"/> KM35M2	 K*4142AC için Kapak, 2M	5	6,00
<input type="radio"/> 412171	 Bağlı Kontaktör, 20A, 1M DIN	1	200,00				
<input type="radio"/> 412015	 Bağlı DIN Enerji Analizörü, 1M DIN	1	138,00				
<input type="radio"/> 412173	 Bağlı Kuru Kontak Modülü, 1M DIN	1	179,00				

* Mekanizmalar aşağıdaki tabloda yer alan kapaklar ile tamamlanmalıdır.

REF.	KAPAK GÖRSELİ	KAPAK REFERANSLARI		
		BEYAZ	SİYAH	KUM BEJİ
K4531C		KW31	KG31	KM31
KW4141AC KG4141AC KM4141AC		KW34M2	KG34M2	KM34M2
KW4142AC KG4142AC KM4142AC		KW35M2	KG35M2	KM35M2

BAĞLI FİŞ/PRİZLER

REF.	BAĞLI FİŞ/PRİZLER	AMB.	AD/€
<input checked="" type="checkbox"/> 4141PC	 Bağlı Alman Tipi Çocuk Korumalı Topraklı Fiş/Priz	1	146,00
<input checked="" type="checkbox"/> 4142PC	 Bağlı Fransız Tipi Çocuk Korumalı Topraklı Fiş/Priz	1	146,00

PRİZLİ AĞ GEÇİDİ MODÜLÜ

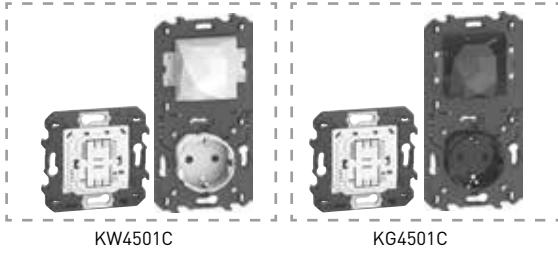

KW4501C

KG4501C



KM51



KW34M2



KG35M2







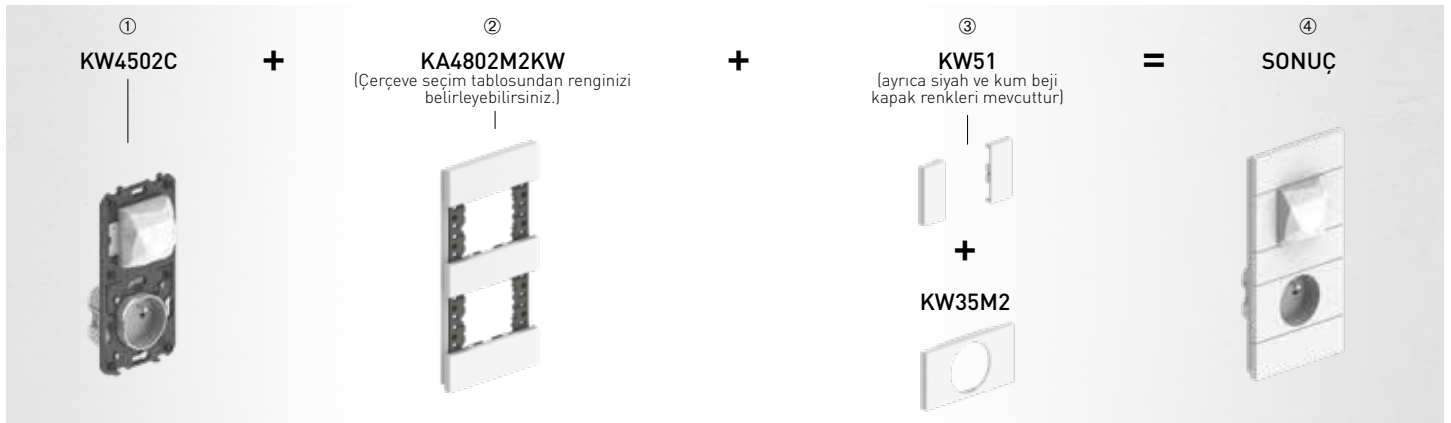

REF.	PRİZLİ AĞ GEÇİDİ MODÜLÜ	AMB. AD/€	REF.	KAPAKLAR	AMB. AD/€
<input type="checkbox"/> KW4501C <input checked="" type="checkbox"/> KG4501C <input type="checkbox"/> KM4501C	Ağ Geçidi Modülü + Alman Std. Çocuk Korumalı Topraklı Priz, 2+2M Kablosuz Giriş/Çıkış Senaryo Kontrol, 2M	1 259,00	<input type="checkbox"/> KW51 <input checked="" type="checkbox"/> KG51 <input type="checkbox"/> KM51	Ağ Geçidi Modülü için Kapak, 2M	10 5,22
<input type="checkbox"/> KW4502C <input checked="" type="checkbox"/> KG4502C <input type="checkbox"/> KM4502C	Ağ Geçidi Mod. + Fransız Std. Çocuk Korumalı Topraklı Priz, 2+2M Kablosuz Giriş/Çıkış Senaryo Kontrol, 2M	1 294,00	<input type="checkbox"/> KW34M2 <input checked="" type="checkbox"/> KG34M2 <input type="checkbox"/> KM34M2	K*4501C için Kapak, 2M	5 6,00
			<input type="checkbox"/> KW35M2 <input checked="" type="checkbox"/> KG35M2 <input type="checkbox"/> KM35M2	K*4502C için Kapak, 2M	5 6,00
			<input type="checkbox"/> KW40M2 <input checked="" type="checkbox"/> KG40M2 <input type="checkbox"/> KM40M2	K4570CW için Kapak, 2M	5 6,00

* Mekanizmalar aşağıdaki tabloda yer alan kapaklar ile tamamlanmalıdır.

REF.	KAPAK GÖRSELİ	KAPAK REFERANSLARI		
		BEYAZ	SİYAH	KUM BEJİ
KW4501C		KW51+KW34M2+KW40M2		
KG4501C		KG51+KG34M2+KG40M2		
KM4501C		KM51+KM34M2+KM40M2		
KW4502C		KW51+KW35M2+KW40M2		
KG4502C		KG51+KG35M2+KG40M2		
KM4502C		KM51+KM35M2+KM40M2		



AĞ GEÇİDİ MODÜLLERİ

REF.	AĞ GEÇİDİ MODÜLLERİ	AMB.	AD/€	REF.	KAPAKLAR	AMB.	AD/€
<input type="radio"/> K4500C	 Ağ Geçidi Modülü, 2M + Kablosuz Giriş/Çıkış Senaryo Cihazı, 2M	1	242,00	<input type="checkbox"/> KW30M2 <input checked="" type="checkbox"/> KG30M2 <input type="checkbox"/> KM30M2	 Ağ Geçidi Modülü için Kapak, 2M	5	6,00
<input type="radio"/> K4510C	 Ağ Geçidi Modülü, 2M+ Kablosuz Giriş/Çıkış Senaryo Cihazı, 1M	1	247,00	<input type="checkbox"/> KW40 <input checked="" type="checkbox"/> KG40 <input type="checkbox"/> KM40	 K4570CWI için Kapak, 1M	10	4,00
<input type="radio"/> 412181	 Pano Tipi Ağ Geçidi Modülü, 2.5M DIN	1	155,00	<input type="checkbox"/> KW40M2 <input checked="" type="checkbox"/> KG40M2 <input type="checkbox"/> KM40M2	 K4570CW için Kapak, 2M	5	6,00
<input checked="" type="checkbox"/> S36GWGC	 Bağlı Tak Çalıştır Ağ Geçidi Modülü	1	170,00				
<input type="checkbox"/> S36GWDC	 Bağlı Tak Çalıştır Ağ Geçidi Modülü	1	170,00				

* Mekanizmalar aşağıdaki tabloda yer alan kapaklar ile tamamlanmalıdır.

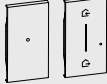
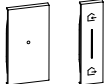
REF.	KAPAK GÖRSELİ	KAPAK REFERANSLARI		
		BEYAZ	SİYAH	KUM BEJİ
K4500C		KW30M2 + KW40M2	KG30M2 + KG40M2	KM30M2 + KM40M2
K4510C		KW30M2 + KW40	KG30M2 + KG40	KM30M2 + KM40

BAĞLI TERMOSTATLAR

XG8002

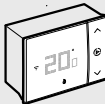

XW8002W

REF.	BAĞLI TERMOSTATLAR	AMB.	AD/€
<input type="checkbox"/> XW8002 <input checked="" type="checkbox"/> XG8002 <input type="checkbox"/> XM8002	 Smarter with Netatmo Termostat	1	398,00
<input type="checkbox"/> XW8002W	 Smarter with Netatmo Termostat, Sıva Üstü	1	398,00

KABLOSUZ SENARYO KONTROL CİHAZLARI



REF.	KABLOSUZ SENARYO KONTROL CİHAZLARI	AMB.	AD/€	REF.	KAPAKLAR	AMB.	AD/€				
MEKANIZMA	<input type="radio"/> K4570CWI		Kablosuz Giriş/Çıkış Senaryo Kontrol Cihazı, 1M	1	100,00	<input type="checkbox"/> KW40 <input checked="" type="checkbox"/> KG40 <input type="checkbox"/> KM40		K4570CWI için Kapak, 1M	10	4,00	
	<input type="radio"/> K4570CW		Kablosuz Giriş/Çıkış Senaryo Kontrol Cihazı, 2M	1	100,00	<input type="checkbox"/> KW41 <input checked="" type="checkbox"/> KG41 <input type="checkbox"/> KM41		K4574CWI için Kapak, 1M	10	4,00	
	<input type="radio"/> K4574CWI		Kablosuz Gece/Gündüz Senaryo Kontrol Cihazı, 1M	1	100,00	KAPAK	<input type="checkbox"/> KW40M2 <input checked="" type="checkbox"/> KG40M2 <input type="checkbox"/> KM40M2		K4570CW için Kapak, 2M	5	6,00
	<input type="radio"/> K4574CW		Kablosuz Gece/Gündüz Senaryo Kontrol Cihazı, 2M	1	110,00		<input type="checkbox"/> KW41M2 <input checked="" type="checkbox"/> KG41M2 <input type="checkbox"/> KM41M2		K4574CW için Kapak, 2M	5	6,00
	<input type="radio"/> K4575CW		Kablosuz Dörtlü Senaryo Kontrol Cihazı, 2M	1	123,00	<input type="checkbox"/> KW37M2 <input checked="" type="checkbox"/> KG37M2 <input type="checkbox"/> KM37M2		K4575CW için Kapak, 1+1M	5	8,00	
	<input type="radio"/> 3528C		Kablosuz Anahtarlık tipi Dörtlü Senaryo Kontrol Cihazı	1	147,00						

* Mekanizmalar aşağıdaki tabloda yer alan kapaklar ile tamamlanmalıdır.

REF.	KAPAK GÖRSELİ	KAPAK REFERANSLARI		
		BEYAZ	SİYAH	KUM BEJİ
K4570CWI		KW40	KG40	KM40
K4570CW		KW40M2	KG40M2	KM40M2
K4574CWI		KW41	KG41	KM41
K4574CW		KW41M2	KG41M2	KM41M2
K4575CW		KW37M2	KG37M2	KM37M2

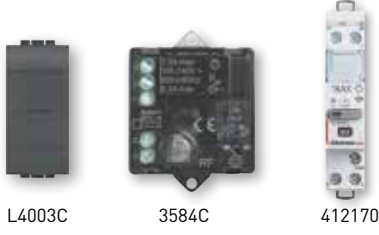
BAĞLI AYDINLATMA KONTROL CİHAZLARI

L4003C

3584C

412170

REF.	BAĞLI AYDINLATMA KONTROL CİHAZLARI	AMB.	AD/€
<input type="checkbox"/> N4003C <input type="checkbox"/> NT4003C <input checked="" type="checkbox"/> L4003C	Bağlı Vavien Anahtar, 1M	1	74,00
<input type="radio"/> 3584C	Bağlı Aydınlatma Kontrol Rölesi	1	88,00
<input type="radio"/> 412170	Aydınlatma için Bağlı DIN Rölesi, 1M DIN	1	133,00

BAĞLI DİMMER/ANAHTAR

L4411C

4411C

N4413CM2

REF.	BAĞLI DİMMER/ANAHTAR	AMB.	AD/€
<input type="checkbox"/> N4411C <input type="checkbox"/> NT4411C <input checked="" type="checkbox"/> L4411C	Bağlı Universal Dimmer/Anahtar, 1M	1	89,00
<input type="checkbox"/> N4412CM2 <input type="checkbox"/> NT4412CM2 <input checked="" type="checkbox"/> L4412CM2	Bağlı Dimmer/Anahtar, 2M	1	120,00
<input type="checkbox"/> N4413CM2 <input type="checkbox"/> NT4413CM2 <input checked="" type="checkbox"/> L4413CM2	Bağlı Dimmer/Anahtar, Nötrsüz, 2M	1	125,00
<input type="radio"/> 4411C	Bağlı Dimmer	1	138,00

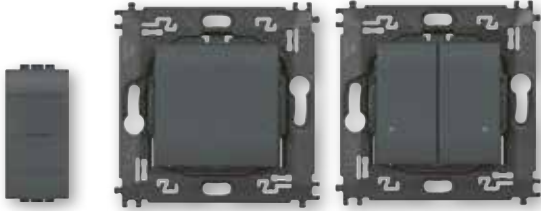
KABLOSUZ AYDINLATMA KONTROL CİHAZLARI

LN4003CWI

L4003CW

L4003DCW

REF.	KABLOSUZ AYDINLATMA KONTROL CİHAZLARI	AMB.	AD/€
<input type="radio"/> LN4003CWI (*)	Kablosuz Aydınlatma Kontrol Cihazı, 1M	1	95,00
<input type="checkbox"/> N4003CW <input type="checkbox"/> NT4003CW <input checked="" type="checkbox"/> L4003CW	Kablosuz Aydınlatma Kontrol Cihazı, 2M	1	81,00
<input type="checkbox"/> N4003DCW <input type="checkbox"/> NT4003DCW <input checked="" type="checkbox"/> L4003DCW	Kablosuz İkili Aydınlatma Kontrol Cihazı, 2M	1	126,00
<input type="radio"/> 3577C	Mekanik Anahtarlar için Kablosuz Modül	1	91,00

KABLOSUZ HAREKET SENSÖRÜ

3585C

REF.	KABLOSUZ HAREKET SENSÖRÜ	AMB.	AD/€
<input type="checkbox"/> 3585C	Kablosuz Hareket Sensörü	1	166,00

(*) Ürün ambalajında beyaz, alüminyum ve antrasit olmak üzere üç farklı tuş kapağı mevcuttur.

BAĞLI PERDE/PANJUR KONTROL CİHAZLARI



L4027C

4027C

L4027CM2

REF.	BAĞLI PERDE/PANJUR KONTROL CİHAZLARI	AMB.	AD/€
<input type="checkbox"/> N4027C <input type="checkbox"/> NT4027C <input type="checkbox"/> L4027C	Bağlı Anahtar Mekanizmalı Perde/Panjur Kontrol Cihazı, 1M	1	95,00
<input type="checkbox"/> N4027CIL <input type="checkbox"/> NT4027CIL <input type="checkbox"/> L4027CIL	Bağlı Liht Mekanizmalı Perde/Panjur Kontrol Cihazı, 1M	1	95,00
<input type="checkbox"/> N4027CM2 <input type="checkbox"/> NT4027CM2 <input type="checkbox"/> L4027CM2	Bağlı Perde/Panjur Kontrol Cihazı, 2M	1	126,00
<input type="radio"/> 4027C	Bağlı Perde/Panjur Kontrol Modülü	1	163,00
<input type="radio"/> 3586C	Bağlı Garaj /Kapı Modülü	1	200,00

PRİZLİ AĞ GEÇİDİ MODÜLÜ

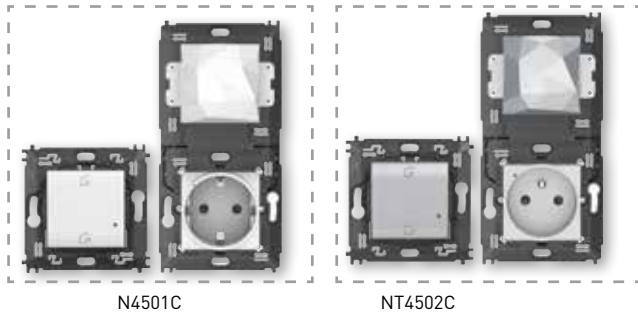

N4501C

NT4502C

REF.	PRİZLİ AĞ GEÇİDİ MODÜLÜ	AMB.	AD/€
<input type="checkbox"/> N4501C <input type="checkbox"/> NT4501C <input type="checkbox"/> L4501C	Ağ Geçidi Modülü + Alman Std. Çocuk Korumalı Topraklı Priz, 2+2M Kablosuz Giriş/Çıkış Senaryo Kontrol, 2M	1	268,00 284,00 268,00
<input type="checkbox"/> N4502C <input type="checkbox"/> NT4502C <input type="checkbox"/> L4502C	Ağ Geçidi Mod. + Fransız Std. Çocuk Korumalı Topraklı Priz, 2+2M Kablosuz Giriş/Çıkış Senaryo Kontrol, 2M	1	303,00 321,00 268,00

KABLOSUZ PERDE/PANJUR KONTROL CİHAZLARI



LN4027CWI

L4027CW

REF.	KABLOSUZ PERDE/PANJUR KONTROL CİHAZLARI	AMB.	AD/€
<input type="radio"/> LN4027CWI (*)	Kablosuz Perde/Panjur Kontrol Cihazı, 1M	1	89,00
<input type="checkbox"/> N4027CW <input type="checkbox"/> NT4027CW <input type="checkbox"/> L4027CW	Kablosuz Perde/Panjur Kontrol Cihazı, 2M	1	100,00

(*) Ürün ambalajında beyaz, alüminyum ve antrasit olmak üzere üç farklı tuş kapağı mevcuttur.

BAĞLI ENERJİ YÖNETİMİ CİHAZLARI

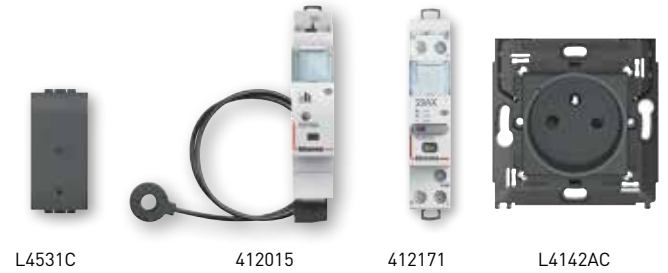

L4531C

412015

412171

L4142AC

REF.	BAĞLI ENERJİ YÖNETİMİ CİHAZLARI	AMB.	AD/€
<input type="checkbox"/> N4531C <input type="checkbox"/> NT4531C <input type="checkbox"/> L4531C	Bağlı Priz Modülü, 1M	1	74,00
<input type="checkbox"/> N4141AC <input type="checkbox"/> NT4141AC <input type="checkbox"/> L4141AC	Bağlı Alman Tipi Çocuk Korumalı Topraklı Priz, Monoblok, 2M	1	106,00
<input type="checkbox"/> N4142AC <input type="checkbox"/> NT4142AC <input type="checkbox"/> L4142AC	Bağlı Fransız Tipi Çocuk Korumalı Topraklı Priz, Monoblok, 2M	1	132,00 135,00 132,00
<input type="radio"/> 412171	Bağlı Kontaktör, 20A, 1M DIN	1	200,00
<input type="radio"/> 412015	Bağlı DIN Enerji Analizörü, 1M DIN	1	138,00
<input type="radio"/> 412173	Bağlı Kuru Kontak Modülü, 1M DIN	1	179,00

AĞ GEÇİDİ MODÜLLERİ



REF.	AĞ GEÇİDİ MODÜLLERİ	AMB.	AD/€
<input type="checkbox"/> N4500C <input type="checkbox"/> NT4500C <input checked="" type="checkbox"/> L4500C		1	231,00
<input type="checkbox"/> N4510C <input type="checkbox"/> NT4510C <input checked="" type="checkbox"/> L4510C		1	236,00
○ 412181		1	155,00
<input type="checkbox"/> S36GWDC <input checked="" type="checkbox"/> S36GWGC		1	170,00

BAĞLI TERMOSTATLAR

REF.	BAĞLI TERMOSTATLAR	AMB.	AD/€
<input type="checkbox"/> XW8002 <input checked="" type="checkbox"/> XG8002		1	398,00
○ XW8002W		1	398,00

BAĞLI FİŞ/PRİZLER

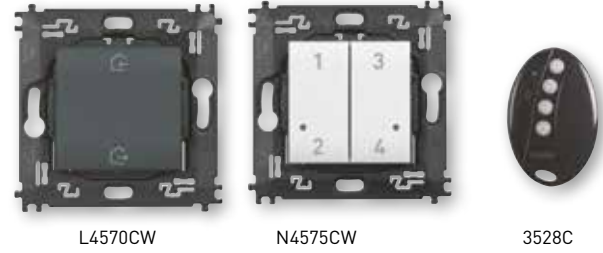
REF.	BAĞLI FİŞ/PRİZLER	AMB.	AD/€
○ 4141PC		1	146,00
○ 4142PC		1	146,00

KABLOSUZ SENARYO KONTROL CİHAZLARI

REF.	KABLOSUZ SENARYO KONTROL CİHAZLARI	AMB.	AD/€
○ LN4570CWI (*)		1	86,00
<input type="checkbox"/> N4570CW <input type="checkbox"/> NT4570CW <input checked="" type="checkbox"/> L4570CW		1	93,00
○ LN4574CWI (*)		1	86,00
<input type="checkbox"/> N4574CW <input type="checkbox"/> NT4574CW <input checked="" type="checkbox"/> L4574CW		1	93,00
<input type="checkbox"/> N4575CW <input type="checkbox"/> NT4575CW <input checked="" type="checkbox"/> L4575CW		1	113,00
○ 3528C		1	147,00

(*) Ürün ambalajında beyaz, alüminyum ve antrasit olmak üzere üç farklı tuş kapağı mevcuttur.

HOME + CONTROL

Tek bir uygulama ile birden fazla cihazı kontrol edin.



Home+Control uygulaması ile Living Now akıllı elektrik sisteminizin tüm fonksiyonlarını iOS veya Android tabanlı mobil cihazlarınızdan evden veya dışardan kontrol edebilirsiniz.

Giriş sayfası tüm sistem bilgilerini göstermektedir.



NELER YAPABİLİRSİNİZ?

1. 8 farklı senaryoyu (giriş, çıkış, gündüz, gece ve özelleştirilebilir 4 farklı senaryo) çalıştırabilir ve düzenleyebilirsiniz.
2. Aydınlatma, perde-panjur, prizlerin ve termostatların durumunu görüntüleyebilir veya kontrol edebilirsiniz.
3. Enerji tüketiminizi anlık olarak görüntüleyebilir, belirlediğiniz limit aşınca sürpriz faturalarla karşılaşmamak için uygulama üzerinden bildirimler alabilirsiniz.
4. Herhangi bir hata durumunda bildirimler alabilirsiniz.
5. Önceliklendirilmiş yük özelliği ile tüm sistemin enerjisinin kesilmesini önleyerek sadece ilgili yükün enerjisini otomatik olarak kesebilirsiniz.



BAĞLI AYDINLATMA KONTROL CİHAZLARI

REF.	BAĞLI AYDINLATMA KONTROL CİHAZLARI	AMB.	AD/€
<input type="checkbox"/> RW4003C <input checked="" type="checkbox"/> RG4003C	Bağlı Vavien Anahtar, 1M	1	71,00
<input type="radio"/> 3584C	Bağlı Aydınlatma Kontrol Rölesi	1	88,00
<input type="radio"/> 412170	Aydınlatma için Bağlı DIN Rölesi, 1M DIN	1	133,00

BAĞLI DİMMER/ANAHTAR

REF.	BAĞLI DİMMER/ANAHTAR	AMB.	AD/€
<input type="checkbox"/> RW4411C <input checked="" type="checkbox"/> RG4411C	Bağlı Universal Dimmer/Anahtar, 1M	1	82,00
<input type="checkbox"/> RW4412CM2 <input checked="" type="checkbox"/> RG4412CM2	Bağlı Dimmer/Anahtar, 2M	1	110,00
<input type="checkbox"/> RW4413CM2 <input checked="" type="checkbox"/> RG4413CM2	Bağlı Dimmer/Anahtar, Nötrsüz, 2M	1	125,00
<input type="radio"/> 4411C	Bağlı Dimmer	1	138,00

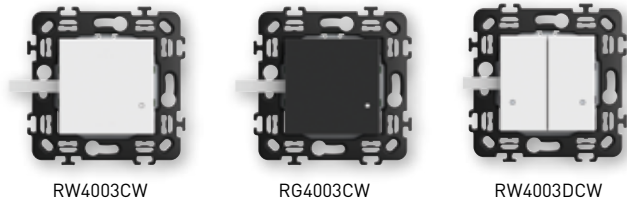
KABLOSUZ AYDINLATMA KONTROL CİHAZLARI

REF.	KABLOSUZ AYDINLATMA KONTROL CİHAZLARI	AMB.	AD/€
<input type="checkbox"/> RW4003CW <input checked="" type="checkbox"/> RG4003CW	Kablosuz Aydınlatma Kontrol Cihazı, 2M	1	75,00
<input type="checkbox"/> RW4003DCW <input checked="" type="checkbox"/> RG4003DCW	Kablosuz İkili Aydınlatma Kontrol Cihazı, 2M	1	121,00
<input type="radio"/> 3577C	Mekanik Anahtarlar için Kablosuz Modül	1	91,00

KABLOSUZ HAREKET SENSÖRÜ

REF.	KABLOSUZ HAREKET SENSÖRÜ	AMB.	AD/€
<input type="checkbox"/> 3585C	Kablosuz Hareket Sensörü	1	166,00

BAĞLI PERDE/PANJUR KONTROL CİHAZLARI



RW4027C RG4027C RW4027CM2 RG4027CM2

REF.	BAĞLI PERDE/PANJUR KONTROL CİHAZLARI	AMB.	AD/€
<input type="checkbox"/> RW4027C <input checked="" type="checkbox"/> RG4027C	Bağlı Perde/Panjur Kontrol Cihazı, 1M	1	89,00
<input type="checkbox"/> RW4027CM2 <input checked="" type="checkbox"/> RG4027CM2	Bağlı Perde/Panjur Kontrol Cihazı, 2M	1	116,00
<input type="radio"/> 4027C	Bağlı Perde/Panjur Kontrol Modülü	1	163,00
<input type="radio"/> 3586C	Bağlı Garaj /Kapı Modülü	1	200,00

BAĞLI ENERJİ YÖNETİMİ CİHAZLARI



RW4531C RG4531C 412171 RW4141AC

REF.	BAĞLI ENERJİ YÖNETİMİ CİHAZLARI	AMB.	AD/€
<input type="checkbox"/> RW4531C <input checked="" type="checkbox"/> RG4531C	Bağlı Priz Modülü, 1M	1	74,00
<input type="checkbox"/> RW4141AC <input checked="" type="checkbox"/> RG4141AC	Bağlı Alman Tipi Çocuk Korumalı Topraklı Priz, Monoblok, 2M	1	119,00
<input type="radio"/> 412171	Bağlı Kontaktör, 20A, 1M DIN	1	200,00
<input type="radio"/> 412015	Bağlı DIN Enerji Analizörü, 1M DIN	1	138,00
<input type="radio"/> 412173	Bağlı Kuru Kontak Modülü, 1M DIN	1	179,00

KABLOSUZ PERDE/PANJUR KONTROL CİHAZLARI

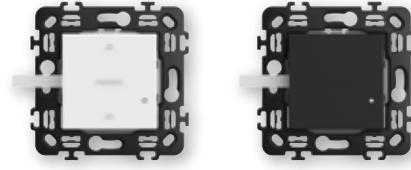

RW4027CW RG4027CW

REF.	KABLOSUZ PERDE/PANJUR KONTROL CİHAZLARI	AMB.	AD/€
<input type="checkbox"/> RW4027CW <input checked="" type="checkbox"/> RG4027CW	Kablosuz Perde/Panjur Kontrol Cihazı, 2M	1	89,00

PRİZLİ AĞ GEÇİDİ MODÜLÜ



RW4501C RG4501C

REF.	PRİZLİ AĞ GEÇİDİ MODÜLÜ	AMB.	AD/€
<input type="checkbox"/> RW4501C <input checked="" type="checkbox"/> RG4501C	Ağ Geçidi Modülü + Alman Std. Çocuk Korumalı Topraklı Priz, 2+2M Kablosuz Giriş/Çıkış Senaryo Kontrol, 2M	1	305,00

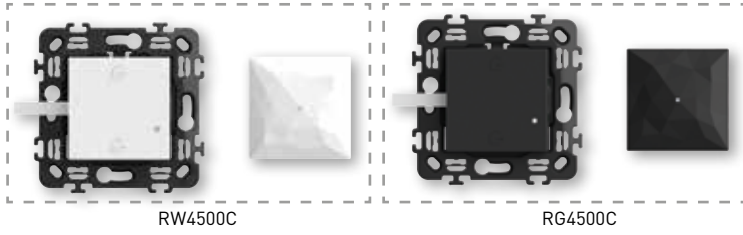
AĞ GEÇİDİ MODÜLLERİ

RW4500C

RG4500C

REF.	AĞ GEÇİDİ MODÜLLERİ	AMB.	AD/€
<input type="checkbox"/> RW4500C <input checked="" type="checkbox"/> RG4500C	Ağ Geçidi Modülü, 2M + Kablosuz Giriş/Çıkış Senaryo Cihazı, 2M	1	221,00
<input type="radio"/> 412181	Pano Tipi Ağ Geçidi Modülü, 2.5M DIN	1	155,00
<input type="checkbox"/> S36GWDC <input checked="" type="checkbox"/> S36GWGC	Bağlı Tak Çalıştır Ağ Geçidi Modülü	1	170,00

BAĞLI FİŞ/PRİZLER

4141PC

4142PC

REF.	BAĞLI FİŞ/PRİZLER	AMB.	AD/€
<input type="radio"/> 4141PC	Bağlı Alman Tipi Çocuk Korumalı Topraklı Fiş/Priz	1	146,00
<input type="radio"/> 4142PC	Bağlı Fransız Tipi Çocuk Korumalı Topraklı Fiş/Priz	1	146,00

BAĞLI TERMOSTATLAR

XG8002

XW8002W

REF.	BAĞLI TERMOSTATLAR	AMB.	AD/€
<input type="checkbox"/> XW8002 <input checked="" type="checkbox"/> XG8002	Smarter with Netatmo Termostat	1	398,00
<input type="checkbox"/> XW8002W	Smarter with Netatmo Termostat, Sıva Üstü	1	398,00

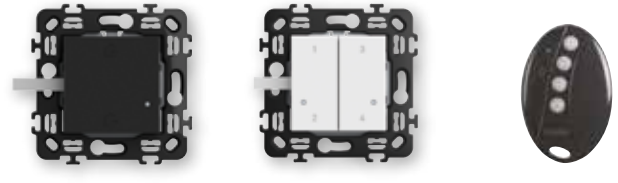
KABLOSUZ SENARYO KONTROL CİHAZLARI

RG4570CW

RW4575CW

3528C

REF.	KABLOSUZ SENARYO KONTROL CİHAZLARI	AMB.	AD/€
<input type="checkbox"/> RW4570CW <input checked="" type="checkbox"/> RG4570CW	Kablosuz Giriş/Çıkış Senaryo Kontrol Cihazı, 2M	1	87,00
<input type="checkbox"/> RW4574CW <input checked="" type="checkbox"/> RG4574CW	Kablosuz Gece/Gündüz Senaryo Kontrol Cihazı, 2M	1	87,00
<input type="checkbox"/> RW4575CW <input checked="" type="checkbox"/> RG4575CW	Kablosuz Dörtlü Senaryo Kontrol Cihazı, 2M	1	106,00
<input type="radio"/> 3528C	Kablosuz Anahtarlık tipi Dörtlü Senaryo Kontrol Cihazı	1	147,00



Gelenekselden Akıllıya

- Sadece birkaç kablolama müdahalesi ile mevcut geleneksel sistemleri Akıllı sistemlere dönüştürmek için,
- Aydınlatmaların, perde-panjurların ve tüketim kontrolü içeren yeni Akıllı sistemler oluşturmak için,
- Çalışma alışkanlıklarınızı değiştirmeden kolayca kontrol için,

İDEAL BİR ÇÖZÜMDÜR.

Classia

WITH

Netatmo

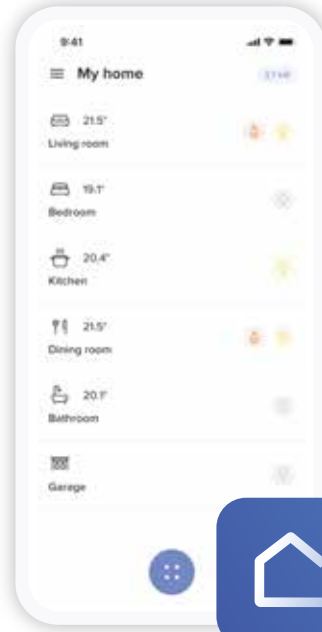

Home + Control



UZAKTAN
KONTROL



SENARYO
KONTROLÜ



SESLE
KONTROL



PLANLANABİLİR
PROGRAMLAR



Classia

by **bticino**

HER ZAMANKİNDEN

DAHA YALIN
AKILLI















EKİM 2024 ₺
FİYAT LİSTESİ

















ANAHTARLAR

REF.	ANAHTARLAR	AMB.	AD/₺	REF.	ANAHTARLAR	AMB.	AD/₺
<input type="checkbox"/> RW4001P* <input checked="" type="checkbox"/> RG4001P*	 Anahtar, 10AX, 250V~, Vidalı Bağlantı, 1M	240	164,00	<input type="checkbox"/> RW4001M2P* <input checked="" type="checkbox"/> RG4001M2P*	 Anahtar, 10AX, 250V~, Vidalı Bağlantı, 2M	40	243,00
<input type="checkbox"/> RW4001L <input checked="" type="checkbox"/> RG4001L	 Işıklı Anahtar, 10AX, 250V~, Vidalı Bağlantı, 1M	20	394,00	<input type="checkbox"/> RW4001M2L <input checked="" type="checkbox"/> RG4001M2L	 Işıklı Anahtar, 10AX, 250V~, Vidalı Bağlantı, 2M	10	454,00
<input type="checkbox"/> RW4001LS <input checked="" type="checkbox"/> RG4001LS	 Işıklı Anahtar, 16AX, 250V~, Boiler Sembollü, Vidalı Bağlantı, 1M	10	512,00	<input type="checkbox"/> RW4001LP <input checked="" type="checkbox"/> RG4001LP	 Işıklı Anahtar, 16AX, 250V~, Isıtıcı Sembollü, Vidalı Bağlantı, 1M	10	512,00
<input type="checkbox"/> RW4001LR <input checked="" type="checkbox"/> RG4001LR	 Işıklı Anahtar, 16AX, 250V~, Fan Sembollü, Vidalı Bağlantı, 1M	10	512,00	<input type="checkbox"/> RW4001LA <input checked="" type="checkbox"/> RG4001LA	 Işıklı Anahtar, 16AX, 250V~, Lamba Sembollü, Vidalı Bağlantı, 1M	10	512,00
<input type="checkbox"/> RW4002L <input checked="" type="checkbox"/> RG4002L	 Işıklı İki Kutuplu Anahtar, 16AX, 250V~, Vidalı Bağlantı, 1M	20	529,00				

REF.	VAVİEN ANAHTARLAR	AMB.	AD/₺	REF.	VAVİEN ANAHTARLAR	AMB.	AD/₺
<input type="checkbox"/> RW4003P* <input checked="" type="checkbox"/> RG4003P*	 Vavien, 10AX, 250V~, Vidalı Bağlantı, 1M	240	171,00	<input type="checkbox"/> RW4003M2P* <input checked="" type="checkbox"/> RG4003M2P*	 Vavien, 10AX, 250V~, Vidalı Bağlantı, 2M	40	243,00
<input type="checkbox"/> RW4003L <input checked="" type="checkbox"/> RG4003L	 Işıklı Vavien, 10AX, 250V~, Vidalı Bağlantı, 1M	20	417,00	<input type="checkbox"/> RW4003M2L <input checked="" type="checkbox"/> RG4003M2L	 Işıklı Vavien, 10AX, 250V~, Vidalı Bağlantı, 2M	10	469,00

REF.	PERMÜTATÖR ANAHTARLAR	AMB.	AD/₺	REF.	PERMÜTATÖR ANAHTARLAR	AMB.	AD/₺
<input type="checkbox"/> RW4004P* <input checked="" type="checkbox"/> RG4004P*	 Permütatör, 10AX, 250V~, Vidalı Bağlantı, 1M	60	422,00	<input type="checkbox"/> RW4004M2P* <input checked="" type="checkbox"/> RG4004M2P*	 Permütatör, 10AX, 250V~, Vidalı Bağlantı, 2M	40	486,00
<input type="checkbox"/> RW4004L <input checked="" type="checkbox"/> RG4004L	 Işıklı Permütatör, 10AX, 250V~, Vidalı Bağlantı, 1M	10	711,00	<input type="checkbox"/> RW4004M2L <input checked="" type="checkbox"/> RG4004M2L	 Işıklı Permütatör, 10AX, 250V~, Vidalı Bağlantı, 2M	10	722,00

REF.	LİHT BUTONLARI	AMB.	AD/₺	REF.	LİHT BUTONLARI	AMB.	AD/₺
<input type="checkbox"/> RW4005P* <input checked="" type="checkbox"/> RG4005P*	 Liht Butonu, 10A, 250V~, Vidalı Bağlantı, 1M	60	171,00	<input type="checkbox"/> RW4005M2P* <input checked="" type="checkbox"/> RG4005M2P*	 Işıklı Liht Butonu, 10A, 250V~, Vidalı Bağlantı, 2M	40	243,00
<input type="checkbox"/> RW4005L <input checked="" type="checkbox"/> RG4005L	 Işıklı Liht Butonu, 10A, 250V~, Vidalı Bağlantı, 1M	20	417,00	<input type="checkbox"/> RW4005M2L <input checked="" type="checkbox"/> RG4005M2L	 Işıklı Liht Butonu, 10A, 250V~, Vidalı Bağlantı, 2M	10	469,00
<input type="checkbox"/> RW4042V230 <input checked="" type="checkbox"/> RG4042V230	 Işıklı Liht Butonu, 10A, 250V~, Zil Sembollü, Vidalı Bağlantı, 1M	10	533,00	<input type="checkbox"/> RW4042V12 <input checked="" type="checkbox"/> RG4042V12	 Işıklı Liht Butonu, 10A, 250V~, Zil Sembollü, Vidalı Bağlantı, 1M	10	533,00
<input type="checkbox"/> RW4043 <input checked="" type="checkbox"/> RG4043	 Işıklı Liht Butonu, 10A, 250V~, Lamba Sembollü, Vidalı Bağlantı, 1M	10	533,00	<input type="checkbox"/> R4040	 Etiketli Liht Butonu, 10A, 250V~, Vidalı Bağlantı, 2M	10	601,00

* Ambalaj tipi farklılık göstermektedir. İlgili değişikliğe sayfa 96'dan ulaşabilirsiniz.



ANAHTARLAR (DEVAM)

REF.	DİĞER ANAHTARLAR	AMB.	AD/₺	REF.	JALUZİ KUMANDA ANAHTARLARI	AMB.	AD/₺
<input type="checkbox"/> RW4001B3	Banyo Anahtarı, 10/2X16AX, 250V~, Vidalı Bağlantı, 3M	10	1.750,00	<input type="checkbox"/> RW4037N <input checked="" type="checkbox"/> RG4037N	Mekanik Kilitlemeli Jaluzi Kumanda Anahtarı, 10A, 250V~, Vidalı Bağlantı, 1M	10	797,00
<input type="checkbox"/> RW4001B4	Banyo Anahtarı, 2X10/2X16AX 250V~, Vidalı Bağlantı, 4M	10	2.130,00	<input type="checkbox"/> RW4027N <input checked="" type="checkbox"/> RG4027N	Jaluzi Kumanda Anahtarı, 10A, 250V~, Vidalı Bağlantı, 1M	10	746,00

HAREKET SENSÖRLERİ





REF.	HAREKET SENSÖRLERİ	AMB.	AD/₺
<input type="checkbox"/> RW4431 <input checked="" type="checkbox"/> RG4431	 Hareket Sensörü, 230V~, Vidalı Bağlantı, 2M	1	4.240,00

DİMMERLER









REF.	DİMMERLER	AMB.	AD/₺
<input type="checkbox"/> RW4402 <input checked="" type="checkbox"/> RG4402	 Rotatif Dimmer, 40-400W, 230V~, Vidalı Bağlantı, 2M	1	2.150,00
<input type="checkbox"/> RW4418M2 <input checked="" type="checkbox"/> RG4418M2	 Universal Dimmer, 230V~, Vidalı Bağlantı, 2M	1	4.900,00

PRİZLER

REF.	ALMAN STANDARDI	AMB.	AD/₺	REF.	İTALYAN STANDARDI	AMB.	AD/₺
<input type="checkbox"/> RW4141P* <input checked="" type="checkbox"/> RG4141P*	 Alman Standardı Topraklı Priz, 16A, 250V~, Vidalı Bağlantı, 2M	40	229,00	<input type="checkbox"/> RW4180P* <input checked="" type="checkbox"/> RG4180P*	 İtalyan Standardı Topraklı Priz, 10/16A, 250V~, Vidalı Bağlantı, 1M	240	229,00
<input type="checkbox"/> RW4141C <input checked="" type="checkbox"/> RG4141C	 Alman Standardı Kapaklı Topraklı Priz, 16A, 250V~, Vidalı Bağlantı, 2M	20	352,00	<input type="checkbox"/> R4180R	 İtalyan Standardı Topraklı Priz, 10/16A, 250V~, Vidalı Bağlantı, 1M, Kırmızı	10	383,00
<input type="checkbox"/> R4141A	 Alman Standardı Topraklı Priz, 16A, 250V~, Vidalı Bağlantı, 2M, Turuncu	10	293,00	<input type="checkbox"/> RW4113 <input checked="" type="checkbox"/> RG4113	 İtalyan Standardı Topraklı Priz, 10A, 250V~, Vidalı Bağlantı, 1M	60	240,00
<input type="checkbox"/> R4141R	 Alman Standardı Topraklı Priz, 16A, 250V~, Vidalı Bağlantı, 2M, Kırmızı	10	293,00	<input type="checkbox"/> RW4140A16P* <input checked="" type="checkbox"/> RG4140A16P*	 İtalyan/Alman Standardı Topraklı Priz, 16A, 250V~, Vidalı Bağlantı, 2M	40	315,00
<input type="checkbox"/> R4141V	 Alman Standardı Topraklı Priz, 16A, 250V~, Vidalı Bağlantı, 2M, Yeşil	10	293,00	<input type="checkbox"/> R4140A16R	 İtalyan/Alman Standardı Topraklı Priz, 16A, 250V~, Vidalı Bağlantı, 2M, Kırmızı	10	383,00





REF.	USB ŞARJ PRİZİ	AMB.	AD/₺	REF.	AVRUPA/AMERİKA STANDARDI	AMB.	AD/₺
<input type="checkbox"/> RW4287C2 <input checked="" type="checkbox"/> RG4287C2	 A+C tipi USB Şarj Prizi, 3A, 230V~, Vidalı Bağlantı, 2M	10	2.290,00	<input type="checkbox"/> RW4125P* <input checked="" type="checkbox"/> RG4125P*	 Avrupa/Amerika Standardı Priz, 16A, 127/250V~, Vidalı Bağlantı, 1M	100	449,00
<input type="checkbox"/> RW4286C2 <input checked="" type="checkbox"/> RG4286C2	 C tipi USB Şarj Prizi, 3A, 230V~, Vidalı Bağlantı, 2M	10	2.760,00				
<input type="checkbox"/> RW4191AC <input checked="" type="checkbox"/> RG4191AC	 A+C tipi USB Şarj Prizi, 3A, 100-240 V~, 1M	10	2.680,00				
<input type="checkbox"/> RW4191AA <input checked="" type="checkbox"/> RG4191AA	 A+A tipi USB Şarj Prizi, 3A, 100-240 V~, 1M	10	2.410,00				

TV PRİZLERİ

REF.	TV PRİZLERİ	AMB.	AD/₺	REF.	TV / SAT PRİZLERİ	AMB.	AD/₺
<input type="checkbox"/> RW4202D <input checked="" type="checkbox"/> RG4202D	 TV Prizi, Yıldız Bağlantı, 1M	10	412,00	<input type="checkbox"/> RW4217M2D <input checked="" type="checkbox"/> RG4217M2D	 TV-SAT Prizi, Yıldız Bağlantı, 2M	10	1.310,00
<input type="checkbox"/> RW4202P14 <input checked="" type="checkbox"/> RG4202P14	 TV Prizi, Sonlu, 10 dB, 1M	10	817,00	<input type="checkbox"/> RW4217M2P14 <input checked="" type="checkbox"/> RG4217M2P14	 TV-SAT Prizi, Geçisli, 14 dB, 2M	10	1.310,00
<input type="checkbox"/> RW4202P10 <input checked="" type="checkbox"/> RG4202P10	 TV Prizi, Geçisli, 14 dB, 1M	10	616,00	<input type="checkbox"/> RW4217M2P10 <input checked="" type="checkbox"/> RG4217M2P10	 TV-SAT Prizi, Sonlu, 10 dB, 2M	10	1.310,00
<input type="checkbox"/> RW4202F <input checked="" type="checkbox"/> RG4202F	 TV Prizi, F Tipi, 1M	10	549,00	<input type="checkbox"/> RW4210M2D <input checked="" type="checkbox"/> RG4210M2D	 TV-R-SAT Prizi, 2M	10	1.310,00

* Ambalaj tipi farklılık göstermektedir. İlgili değişikliğe sayfa 96'dan ulaşabilirsiniz.



DATA VE TELEFON PRİZLERİ

REF.	DATA PRİZLERİ	AMB.	AD/₺	REF.	TELEFON PRİZİ	AMB.	AD/₺
<input type="checkbox"/> RW4279C5E <input checked="" type="checkbox"/> RG4279C5E	 Data Priz, CAT5e UTP, Aletsiz, 1M	10	543,00	<input type="checkbox"/> RW4258RJ11 <input checked="" type="checkbox"/> RG4258RJ11	 Telefon Priz, RJ11, 1M	10	474,00
<input type="checkbox"/> RW4279C6 <input checked="" type="checkbox"/> RG4279C6	 Data Priz, Cat6 UTP, Aletsiz, 1M	10	718,00				
<input type="checkbox"/> RW4279C6S <input checked="" type="checkbox"/> RG4279C6S	 Data Priz, CAT6 STP, Aletsiz, 1M	10	838,00				
<input type="checkbox"/> RW4279C6AS <input checked="" type="checkbox"/> RG4279C6AS	 Data Priz, CAT6A STP, Aletsiz, 1M	10	968,00				



İKAZ VE SİNYAL MEKANİZMALARI



REF.	ZİLLER	AMB.	AD/₺	REF.	TAŞINABİLİR LAMBA	AMB.	AD/₺
<input type="checkbox"/> RW4351V230 <input checked="" type="checkbox"/> RG4351V230	 Zil, 8VA, 230V~, Vidalı Bağlantı, 1M	1	896,00	<input type="checkbox"/> R4380	 Taşınabilir Lamba, . 127/230V~, Vidalı Bağlantı, 2M	1	3.290,00
<input type="checkbox"/> RW4356V230 <input checked="" type="checkbox"/> RG4356V230	 Buzzer, 8VA, 230V~, Vidalı Bağlantı, 1M	1	896,00				

BOŞLUK KAPAKLARI

REF.	BOŞLUK KAPAKLARI	AMB.	AD/₺
<input type="checkbox"/> RW4950 <input checked="" type="checkbox"/> RG4950	 Boşluk Kapağı, 1M	10	42,40
<input type="checkbox"/> RW4953 <input checked="" type="checkbox"/> RG4953	 Kablo Çıkış Kapağı, 1M	10	373,00





OTEL ÇÖZÜMLERİ

REF.	KORDONLU LİHT BUTONU	AMB.	AD/₺
<input type="checkbox"/> RW4033 <input checked="" type="checkbox"/> RG4033	 Liht Butonu, 10A, 250V~, Vidalı Bağlantı, 1M	1	804,00
REF.	TIRAŞ PRİZİ	AMB.	AD/₺
<input type="checkbox"/> RW4177 <input checked="" type="checkbox"/> RG4177	 Tıraş Prizi, 20VA, 230V~, Vidalı Bağlantı, 3M	1	5.030,00
REF.	TERMOSTAT	AMB.	AD/₺
<input type="checkbox"/> RW4441 <input checked="" type="checkbox"/> RG4441	 Elektronik Ortam Termostatı, 8A, 250V~, Vidalı Bağlantı, 2M	1	7.180,00

REF.	OTEL ÇAĞRI ÜNİTELERİ	AMB.	AD/₺
<input type="checkbox"/> RW4028HN <input checked="" type="checkbox"/> RG4028HN	 Otel Çağrı Butonu, 10A, 250V~, Vidalı Bağlantı, 1M	1	630,00
○ R4373	 Otel Çağrı Göstergesi, 10A, 127/230V~, Vidalı Bağlantı, 1M	1	1.440,00
REF.	ENERGY SAVER	AMB.	AD/₺
<input type="checkbox"/> RW4549 <input checked="" type="checkbox"/> RG4549	 Mekanik Anahtarlı Energy Saver, 230V~, Vidalı Bağlantı, 2M	1	3.290,00









* Farklı energy saver çözümlerimiz için satış ofisimize danışınız.

KAİDELER

REF.	KAİDELER	AMB.	AD/₺
○ R4702GTR	 Kaide, Tırnaklı, 2M	40	67,30
○ R4702P*	 Kaide, Vidalı, 2M	60 75	95,50
○ R4703P*	 Kaide, 3M	100 150	76,50
○ R4704P*	 Kaide, 4M	50	102,00
○ R4707	 Kaide, 7M	10	154,00

* Ambalaj tipi farklılık göstermektedir. İlgili değişikliğe sayfa 96'den ulaşabilirsiniz.

IP KORUMALI BUATLAR VE ÇERÇEVELER

REF.	IP40 IDROBOX S.Ü. BUATLAR	AMB.	AD/₺
○ 27401	 IP40 Sıva Üstü Buat, 1M, Gri	10	234,00
○ 27402	 IP40 Sıva Üstü Buat, 2M, Gri	10	234,00
○ 27403	 IP40 Sıva Üstü Buat, 3M, Gri	5	308,00
○ 27404	 IP40 Sıva Üstü Buat, 4M, Gri	5	496,00
REF.	IP55 IDROBOX S.Ü. BUATLAR	AMB.	AD/₺
○ 27501	 IP55 Sıva Üstü Buat, 1M, Gri	10	398,00
○ 27502	 IP55 Sıva Üstü Buat, 2M, Gri	10	398,00
○ 27503	 IP55 Sıva Üstü Buat, 3M, Gri	5	496,00
○ 27504	 IP55 Sıva Üstü Buat, 4M, Gri	5	745,00
REF.	IP55 IDROBOX ÇERÇEVELER	AMB.	AD/₺
○ 27602	 IP55 Kapak, 2M, Gri	1	496,00
○ 27603	 IP55 Kapak, 3M, Gri	1	496,00
○ 27604	 IP55 Kapak, 4M, Gri	1	830,00
□ 27602B	IP55 Kapak 2M - Beyaz	1	470,00
□ 27603B	IP55 Kapak 3M - Beyaz	1	470,00
□ 27604B	IP55 Kapak 4M - Beyaz	1	787,00
■ 27602G	IP55 Kapak 2M - Siyah	1	965,00
■ 27603G	IP55 Kapak 3M - Siyah	1	965,00
■ 27604G	IP55 Kapak 4M - Siyah	1	1.030,00

ÇERÇEVELER

REF.	YALIN	AMB.	AD/₺	REF.	ÇERÇEVELİ	AMB.	AD/₺
R4801RW	Çerçeve, Beyaz, 2/1M	25	141,00	R4801ES	Çerçeve, Satine Buz Beyazı, 2/1M	25	251,00
R4802RW	Çerçeve, Beyaz, 2M	25	92,30	R4802ES	Çerçeve, Satine Buz Beyazı, 2M	25	165,00
R4802M2RW	Çerçeve, Beyaz, 2+2M	10	210,00	R4802M2ES	Çerçeve, Satine Buz Beyazı, 2+2M	10	361,00
R4802M3RW	Çerçeve, Beyaz, 2+2+2M	10	390,00	R4802M3ES	Çerçeve, Satine Buz Beyazı, 2+2+2M	10	469,00
R4802M4RW	Çerçeve, Beyaz, 2+2+2+2M	10	419,00	R4802M4ES	Çerçeve, Satine Buz Beyazı, 2+2+2+2M	10	622,00
R4802M5RW	Çerçeve, Beyaz, 2+2+2+2+2M	5	524,00	R4802M5ES	Çerçeve, Satine Buz Beyazı, 2+2+2+2+2M	5	728,00
R4803M1RW	Çerçeve, Beyaz, 3/1M	25	117,00	R4803M1ES	Çerçeve, Satine Buz Beyazı, 3/1M	25	206,00
R4819RW	Çerçeve, Beyaz, 3/2M	25	117,00	R4819ES	Çerçeve, Satine Buz Beyazı, 3/2M	25	206,00
R4803RW	Çerçeve, Beyaz, 3M	25	111,00	R4803ES	Çerçeve, Satine Buz Beyazı, 3M	25	181,00
R4804RW	Çerçeve, Beyaz, 4M	10	208,00	R4804ES	Çerçeve, Satine Buz Beyazı, 4M	10	297,00
R4807RW	Çerçeve, Beyaz, 7M	10	224,00	R4807ES	Çerçeve, Satine Buz Beyazı, 7M	10	376,00
R4801BC	Çerçeve, Siyah, 2/1M	25	141,00	R4801CS	Çerçeve, Satine Krem, 2/1M	25	251,00
R4802BC	Çerçeve, Siyah, 2M	25	92,30	R4802CS	Çerçeve, Satine Krem, 2M	25	165,00
R4802M2BC	Çerçeve, Siyah, 2+2M	10	210,00	R4802M2CS	Çerçeve, Satine Krem, 2+2M	10	361,00
R4802M3BC	Çerçeve, Siyah, 2+2+2M	10	390,00	R4802M3CS	Çerçeve, Satine Krem, 2+2+2M	10	469,00
R4802M4BC	Çerçeve, Siyah, 2+2+2+2M	10	419,00	R4802M4CS	Çerçeve, Satine Krem, 2+2+2+2M	10	622,00
R4802M5BC	Çerçeve, Siyah, 2+2+2+2+2M	5	524,00	R4802M5CS	Çerçeve, Satine Krem, 2+2+2+2+2M	5	728,00
R4803M1BC	Çerçeve, Siyah, 3/1M	25	117,00	R4803M1CS	Çerçeve, Satine Krem, 3/1M	25	206,00
R4819BC	Çerçeve, Siyah, 3/2M	25	117,00	R4819CS	Çerçeve, Satine Krem, 3/2M	25	206,00
R4803BC	Çerçeve, Siyah, 3M	25	111,00	R4803CS	Çerçeve, Satine Krem, 3M	25	181,00
R4804BC	Çerçeve, Siyah, 4M	10	208,00	R4804CS	Çerçeve, Satine Krem, 4M	10	297,00
R4807BC	Çerçeve, Siyah, 7M	10	224,00	R4807CS	Çerçeve, Satine Krem, 7M	10	376,00
R4801CR	Çerçeve, Krem, 2/1M	25	141,00	R4801WS	Çerçeve, Satine Beyaz, 2/1M	25	251,00
R4802CR	Çerçeve, Krem, 2M	25	92,30	R4802WS	Çerçeve, Satine Beyaz, 2M	25	165,00
R4802M2CR	Çerçeve, Krem, 2+2M	10	210,00	R4802M2WS	Çerçeve, Satine Beyaz, 2+2M	10	361,00
R4802M3CR	Çerçeve, Krem, 2+2+2M	10	390,00	R4802M3WS	Çerçeve, Satine Beyaz, 2+2+2M	10	469,00
R4802M4CR	Çerçeve, Krem, 2+2+2+2M	10	419,00	R4802M4WS	Çerçeve, Satine Beyaz, 2+2+2+2M	10	622,00
R4802M5CR	Çerçeve, Krem, 2+2+2+2+2M	5	524,00	R4802M5WS	Çerçeve, Satine Beyaz, 2+2+2+2+2M	5	728,00
R4803M1CR	Çerçeve, Krem, 3/1M	25	117,00	R4803M1WS	Çerçeve, Satine Beyaz, 3/1M	25	206,00
R4819CR	Çerçeve, Krem, 3/2M	25	117,00	R4819WS	Çerçeve, Satine Beyaz, 3/2M	25	206,00
R4803CR	Çerçeve, Krem, 3M	25	111,00	R4803WS	Çerçeve, Satine Beyaz, 3M	25	181,00
R4804CR	Çerçeve, Krem, 4M	10	208,00	R4804WS	Çerçeve, Satine Beyaz, 4M	10	297,00
R4807CR	Çerçeve, Krem, 7M	10	224,00	R4807WS	Çerçeve, Satine Beyaz, 7M	10	376,00
R4801MK	Çerçeve, Moka, 2/1M	25	141,00	R4801BG	Çerçeve, Satine Siyah, 2/1M	25	251,00
R4802MK	Çerçeve, Moka, 2M	25	92,30	R4802BG	Çerçeve, Satine Siyah, 2M	25	165,00
R4802M2MK	Çerçeve, Moka, 2+2M	10	210,00	R4802M2BG	Çerçeve, Satine Siyah, 2+2M	10	361,00
R4802M3MK	Çerçeve, Moka, 2+2+2M	10	390,00	R4802M3BG	Çerçeve, Satine Siyah, 2+2+2M	10	469,00
R4802M4MK	Çerçeve, Moka, 2+2+2+2M	10	419,00	R4802M4BG	Çerçeve, Satine Siyah, 2+2+2+2M	10	622,00
R4802M5MK	Çerçeve, Moka, 2+2+2+2+2M	5	524,00	R4802M5BG	Çerçeve, Satine Siyah, 2+2+2+2+2M	5	728,00
R4803M1MK	Çerçeve, Moka, 3/1M	25	117,00	R4803M1BG	Çerçeve, Satine Siyah, 3/1M	25	206,00
R4819MK	Çerçeve, Moka, 3/2M	25	117,00	R4819BG	Çerçeve, Satine Siyah, 3/2M	25	206,00
R4803MK	Çerçeve, Moka, 3M	25	111,00	R4803BG	Çerçeve, Satine Siyah, 3M	25	181,00
R4804MK	Çerçeve, Moka, 4M	10	208,00	R4804BG	Çerçeve, Satine Siyah, 4M	10	297,00
R4807MK	Çerçeve, Moka, 7M	10	224,00	R4807BG	Çerçeve, Satine Siyah, 7M	10	376,00

ÇERÇEVELER (DEVAM)

REF.	RENKLİ	AMB.	AD/₺	REF.	ÇARPICI	AMB.	AD/₺
R4801TM	Çerçeve, Metalik Titanyum, 2/1M	25	293,00	R4801WD	Çerçeve, Beyaz Altın, 2/1M	25	680,00
R4802TM	Çerçeve, Metalik Titanyum, 2M	25	198,00	R4802WD	Çerçeve, Beyaz Altın, 2M	25	606,00
R4802M2TM	Çerçeve, Metalik Titanyum, 2+2M	10	390,00	R4802M2WD	Çerçeve, Beyaz Altın, 2+2M	10	907,00
R4802M3TM	Çerçeve, Metalik Titanyum, 2+2+2M	10	608,00	R4802M3WD	Çerçeve, Beyaz Altın, 2+2+2M	10	1.360,00
R4802M4TM	Çerçeve, Metalik Titanyum, 2+2+2+2M	10	809,00	R4802M4WD	Çerçeve, Beyaz Altın, 2+2+2+2M	10	1.850,00
R4802M5TM	Çerçeve, Metalik Titanyum, 2+2+2+2+2M	5	968,00	R4802M5WD	Çerçeve, Beyaz Altın, 2+2+2+2+2M	5	2.290,00
R4803M1TM	Çerçeve, Metalik Titanyum, 3/1M	25	293,00	R4803M1WD	Çerçeve, Beyaz Altın, 3/1M	25	713,00
R4819TM	Çerçeve, Metalik Titanyum, 3/2M	25	293,00	R4819WD	Çerçeve, Beyaz Altın, 3/2M	25	713,00
R4803TM	Çerçeve, Metalik Titanyum, 3M	25	281,00	R4803WD	Çerçeve, Beyaz Altın, 3M	25	693,00
R4804TM	Çerçeve, Metalik Titanyum, 4M	10	369,00	R4804WD	Çerçeve, Beyaz Altın, 4M	10	858,00
R4807TM	Çerçeve, Metalik Titanyum, 7M	10	554,00	R4807WD	Çerçeve, Beyaz Altın, 7M	10	1.300,00
R4801SF	Çerçeve, Siena Soft, 2/1M	25	293,00	R4801WR	Çerçeve, Beyaz Krom, 2/1M	25	680,00
R4802SF	Çerçeve, Siena Soft, 2M	25	198,00	R4802WR	Çerçeve, Beyaz Krom, 2M	25	606,00
R4802M2SF	Çerçeve, Siena Soft, 2+2M	10	390,00	R4802M2WR	Çerçeve, Beyaz Krom, 2+2M	10	907,00
R4802M3SF	Çerçeve, Siena Soft, 2+2+2M	10	608,00	R4802M3WR	Çerçeve, Beyaz Krom, 2+2+2M	10	1.360,00
R4802M4SF	Çerçeve, Siena Soft, 2+2+2+2M	10	809,00	R4802M4WR	Çerçeve, Beyaz Krom, 2+2+2+2M	10	1.850,00
R4802M5SF	Çerçeve, Siena Soft, 2+2+2+2+2M	5	968,00	R4802M5WR	Çerçeve, Beyaz Krom, 2+2+2+2+2M	5	2.290,00
R4803M1SF	Çerçeve, Siena Soft, 3/1M	25	293,00	R4803M1WR	Çerçeve, Beyaz Krom, 3/1M	25	713,00
R4819SF	Çerçeve, Siena Soft, 3/2M	25	293,00	R4819WR	Çerçeve, Beyaz Krom, 3/2M	25	713,00
R4803SF	Çerçeve, Siena Soft, 3M	25	281,00	R4803WR	Çerçeve, Beyaz Krom, 3M	25	693,00
R4804SF	Çerçeve, Siena Soft, 4M	10	369,00	R4804WR	Çerçeve, Beyaz Krom, 4M	10	858,00
R4807SF	Çerçeve, Siena Soft, 7M	10	554,00	R4807WR	Çerçeve, Beyaz Krom, 7M	10	1.300,00
R4801LM	Çerçeve, Metalik Mavi, 2/1M	25	293,00	R4801BH	Çerçeve, Siyah Nikel, 2/1M	25	680,00
R4802LM	Çerçeve, Metalik Mavi, 2M	25	198,00	R4802BH	Çerçeve, Siyah Nikel, 2M	25	606,00
R4802M2LM	Çerçeve, Metalik Mavi, 2+2M	10	390,00	R4802M2BH	Çerçeve, Siyah Nikel, 2+2M	10	907,00
R4802M3LM	Çerçeve, Metalik Mavi, 2+2+2M	10	608,00	R4802M3BH	Çerçeve, Siyah Nikel, 2+2+2M	10	1.360,00
R4802M4LM	Çerçeve, Metalik Mavi, 2+2+2+2M	10	809,00	R4802M4BH	Çerçeve, Siyah Nikel, 2+2+2+2M	10	1.850,00
R4802M5LM	Çerçeve, Metalik Mavi, 2+2+2+2+2M	5	968,00	R4802M5BH	Çerçeve, Siyah Nikel, 2+2+2+2+2M	5	2.290,00
R4803M1LM	Çerçeve, Metalik Mavi, 3/1M	25	293,00	R4803M1BH	Çerçeve, Siyah Nikel, 3/1M	25	713,00
R4819LM	Çerçeve, Metalik Mavi, 3/2M	25	293,00	R4819BH	Çerçeve, Siyah Nikel, 3/2M	25	713,00
R4803LM	Çerçeve, Metalik Mavi, 3M	25	281,00	R4803BH	Çerçeve, Siyah Nikel, 3M	25	693,00
R4804LM	Çerçeve, Metalik Mavi, 4M	10	369,00	R4804BH	Çerçeve, Siyah Nikel, 4M	10	858,00
R4807LM	Çerçeve, Metalik Mavi, 7M	10	554,00	R4807BH	Çerçeve, Siyah Nikel, 7M	10	1.300,00
R4801TF	Çerçeve, Terra Soft, 2/1M	25	293,00	R4801BD	Çerçeve, Siyah Altın, 2/1M	25	680,00
R4802TF	Çerçeve, Terra Soft, 2M	25	198,00	R4802BD	Çerçeve, Siyah Altın, 2M	25	606,00
R4802M2TF	Çerçeve, Terra Soft, 2+2M	10	390,00	R4802M2BD	Çerçeve, Siyah Altın, 2+2M	10	907,00
R4802M3TF	Çerçeve, Terra Soft, 2+2+2M	10	608,00	R4802M3BD	Çerçeve, Siyah Altın, 2+2+2M	10	1.360,00
R4802M4TF	Çerçeve, Terra Soft, 2+2+2+2M	10	809,00	R4802M4BD	Çerçeve, Siyah Altın, 2+2+2+2M	10	1.850,00
R4802M5TF	Çerçeve, Terra Soft, 2+2+2+2+2M	5	968,00	R4802M5BD	Çerçeve, Siyah Altın, 2+2+2+2+2M	5	2.290,00
R4803M1TF	Çerçeve, Terra Soft, 3/1M	25	293,00	R4803M1BD	Çerçeve, Siyah Altın, 3/1M	25	713,00
R4819TF	Çerçeve, Terra Soft, 3/2M	25	293,00	R4819BD	Çerçeve, Siyah Altın, 3/2M	25	713,00
R4803TF	Çerçeve, Terra Soft, 3M	25	281,00	R4803BD	Çerçeve, Siyah Altın, 3M	25	693,00
R4804TF	Çerçeve, Terra Soft, 4M	10	369,00	R4804BD	Çerçeve, Siyah Altın, 4M	10	858,00
R4807TF	Çerçeve, Terra Soft, 7M	10	554,00	R4807BD	Çerçeve, Siyah Altın, 7M	10	1.300,00

Classia by **bticino**

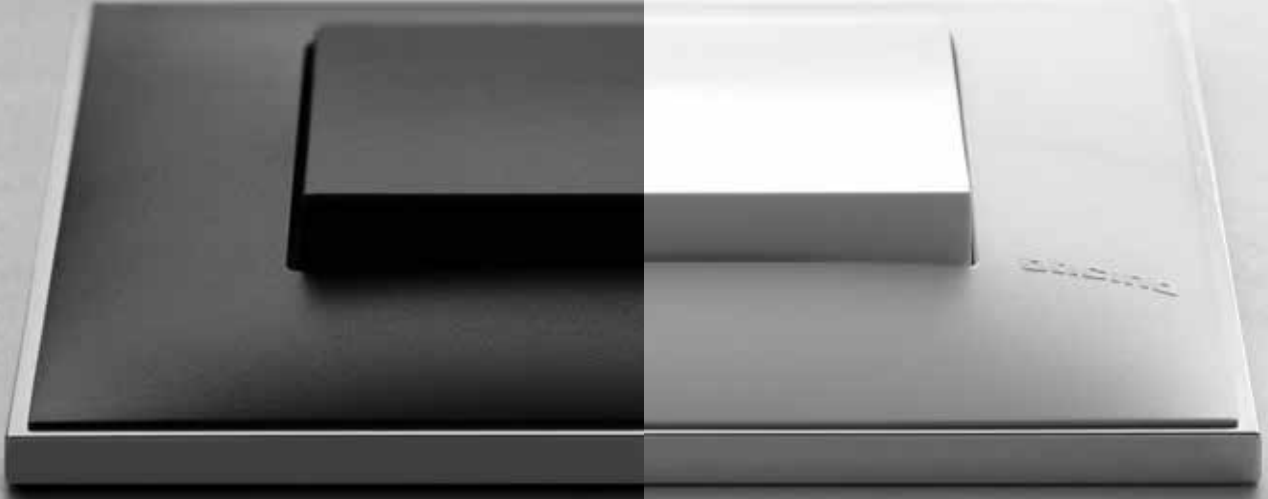

SATİNE SİYAH

PARLAK BEYAZ



Hacim kazandıran hafif kavisli düğme yüzeyi ile kontrast oluşturan modern, sade ve keskin hatlı çerçeveler ile tamamlanan Classia by Bticino kendine özgü stilini duvarlarınıza yansıtıyor. Seçkin tarzı, yenilikçi yaklaşımı, farklı standartlara uygun yapısı ve kolay montaj imkanı ile alışkanlıkları değiştirmeden farkını ortaya koyuyor.

bticino







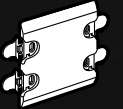
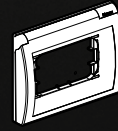
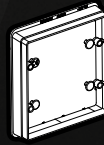
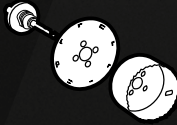
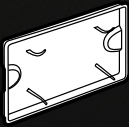
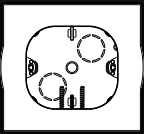

bticino



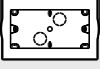





KURULUM AKSESUARLARI

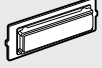

BUATLAR

REF.	BUATLAR	AMB.	AD/€
○ 502E	Beton Duvar İçin Buat, 2M	50	2,300
○ 503E	Beton Duvar İçin Buat, 3M	15	2,430
○ 504E	Beton Duvar İçin Buat, 4M	5	2,590
○ 506E	Beton Duvar İçin Buat, 3+3M	2	3,220
○ 506L	Beton Duvar İçin Buat, 6/7M	1	4,050
○ 502W	Beton Duvar İçin Buat, AIR Serisi Kaide İçin, 2M	1	8,360
○ PB502N	Alçıpan Duvar İçin Buat, 2M	5	2,550
○ PB503N	Alçıpan Duvar İçin Buat, 3M	5	2,550
○ PB504N	Alçıpan Duvar İçin Buat, 4M	5	3,830
○ PB506N	Alçıpan Duvar İçin Buat, 6/7M	5	5,220
○ PB526N	Alçıpan Duvar İçin Buat, 3+3M	5	5,220
○ PB502W	Alçıpan Duvar İçin Buat, AIR Serisi Kaide İçin, 2M	5	8,100
○ PB502A	PB502N İçin Kasa Birleştirici	5	2,800
○ 502BI	 Siva Üstü Kasa, 2M	1	11,010
○ 503BI	 Siva Üstü Kasa, 3M	1	11,010
○ 504BI	 Siva Üstü Kasa, 4M	1	12,600
○ 502LP	 Siva Üstü Kasa, 2M	10	16,180
○ 503LP	 Siva Üstü Kasa, 3M	10	16,180
○ 504LP	 Siva Üstü Kasa, 4M	10	25,010

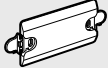
KORUMA KILIFLARI VE AKSESUARLAR





REF.	KAİDE KORUMA KAPAKLARI	AMB.	AD/€
○ LN4782	 2M Kaideler İçin Koruma Kapağı	100	1,260
○ LN4783	 3M Kaideler İçin Koruma Kapağı	100	0,930
○ LN4784	 4M Kaideler İçin Koruma Kapağı	50	1,440
○ LN4787	 7M Kaideler İçin Koruma Kapağı	50	1,480
○ LN4786	 3+3M Kaideler İçin Koruma Kapağı	50	2,620
REF.	BUAT KORUMA KAPAKLARI	AMB.	AD/€
○ 503CG	 3M Modüler Buat (503E) İçin Koruma Kapağı	200	0,610
○ 503EV	 3M Modüler Buat (503E) İçin Bölücü Aparat	50	0,400
○ 503EC	 3M Modüler Buat (503E) İçin Kapak	1	1,850
○ 504EC	 4M Modüler Buat (504E) İçin Kapak	30	8,740
○ 506EC	 6M Modüler Buat (506E) İçin Kapak	1	13,790
○ 503ED	 2M (502E), 3M (503E), 4M (504E) Modüler Buatlar İçin Birleştirici Aparat	100	2,370

IP KORUMALI BUATLAR VE ÇERÇEVELER - LIVING LIGHT

REF.	IP40 IDROBOX S.Ü. BUATLAR	AMB.	AD/€
○ 24401	Idrobox Sıva Üstü Buat, IP40, 1M	1	8,510
○ 24402	Idrobox Sıva Üstü Buat, IP40, 2M	1	8,430
○ 24403	Idrobox Sıva Üstü Buat, IP40, 3M	1	11,210
○ 24404	Idrobox Sıva Üstü Buat, IP40, 4M	1	15,240
○ 24404/2	Idrobox Sıva Üstü Buat, IP40, 2+2M	1	11,210
○ 24406	Idrobox Sıva Üstü Buat, IP40, 6M	1	14,090

REF.	IP55 IDROBOX S.Ü. BUATLAR	AMB.	AD/€
○ 24501	Idrobox Sıva Üstü Buat, IP55, 1M	1	11,610
○ 24502	Idrobox Sıva Üstü Buat, IP55, 2M	1	11,610
○ 24503	Idrobox Sıva Üstü Buat, IP55, 3M	1	13,200
○ 24504	Idrobox Sıva Üstü Buat, IP55, 4M	1	21,840

KURULUM AKSESUARLARI

REF.	BUAT PLAKASI - AIR İÇİN	AMB.	AD/€
○ 503ESC	 AIR Çerçeve Kullanıldığında 3M Modüler Buat (503E) İçin Derinleştirici Aparat	5	4,350
○ 504ESC	 AIR Çerçeve Kullanıldığında 4M Modüler Buat (504E) İçin Derinleştirici Aparat	5	5,060
○ 506LSC	 AIR Çerçeve Kullanıldığında 6M Modüler Buat (503L) İçin Derinleştirici Aparat	3	8,380
○ 506ESC	 AIR Çerçeve Kullanıldığında 3+3M Modüler Buat (506E) İçin Derinleştirici Aparat	3	12,740

REF.	IP55 IDROBOX ÇERÇEVELER	AMB.	AD/€
■ 24602L	Idrobox Çerçeve, IP55, 2M	1	24,540
■ 24602N	Idrobox Çerçeve, IP55, 2M	1	16,990
■ 24602	Idrobox Çerçeve, IP55, 2M	1	16,990
■ 24603	Idrobox Çerçeve, IP55, 3M	1	18,870
■ 24603L	Idrobox Çerçeve, IP55, 3M	1	26,430
■ 24603N	Idrobox Çerçeve, IP55, 3M	1	18,870
■ 24604L	Idrobox Çerçeve, IP55, 4M	1	28,310
■ 24604N	Idrobox Çerçeve, IP55, 4M	1	22,650
■ 24604	Idrobox Çerçeve, IP55, 4M	1	22,650
○ 26603	 Idrobox Çerçeve, IP44, 3M	1	30,200

REF.	IP40 IDROBOX AKSESUARLARI	AMB.	AD/€
○ 25700	 Conta, IP55, Ø5-14-16-20 mm	10	0,410
○ 25700F/16	 Boru Contası, Ø16mm	10	16,870
○ 25700F/20	 Boru Contası, Ø20mm	10	19,750
○ 25701	 IP Korumalı Buatlar İçin Bölümleme Parçası, Yatay	10	2,110
○ 25701V	 IP Korumalı Buatlar İçin Bölümleme Parçası, Dikey	10	2,110

Idrobox ÇERÇEVELER



IP44
KORUMA KAPAK



bticino

TEKNİK ÇİZİMLER

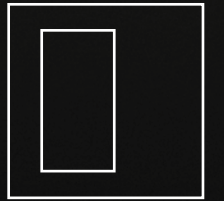
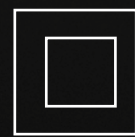
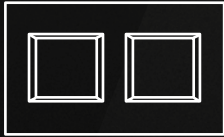

CLASSIA by BTICINO ÇERÇEVELER

Avrupa standardına uygun sistemler için (Geçmeli sistemler için)

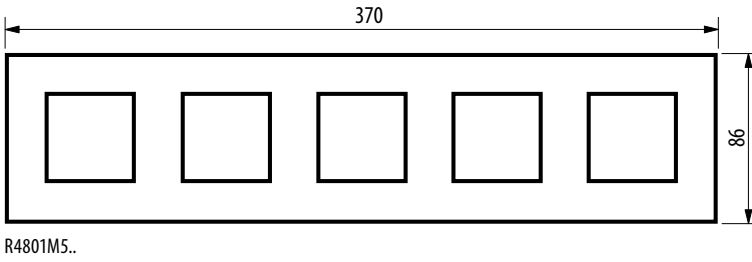
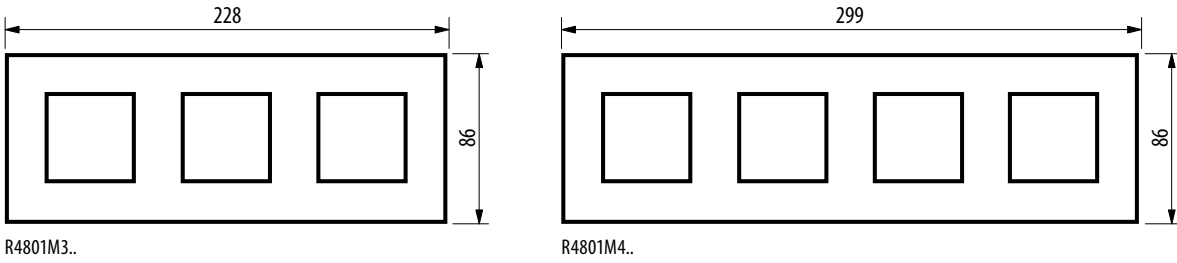
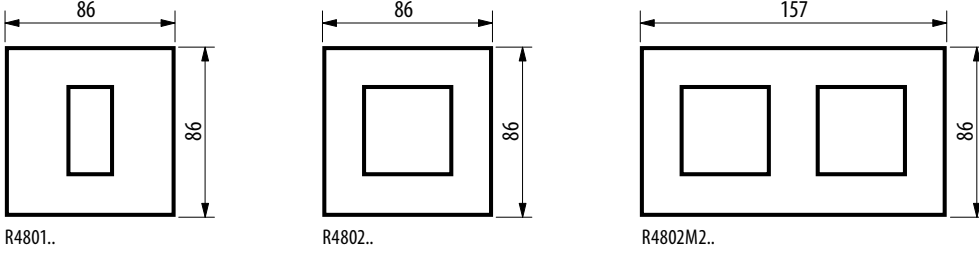

İtalyan standardına uygun sistemler için (Modüler sistemler için)

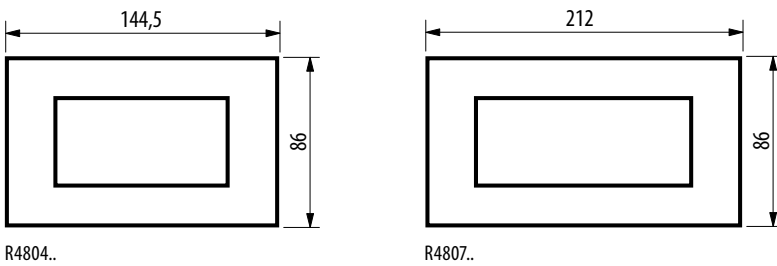
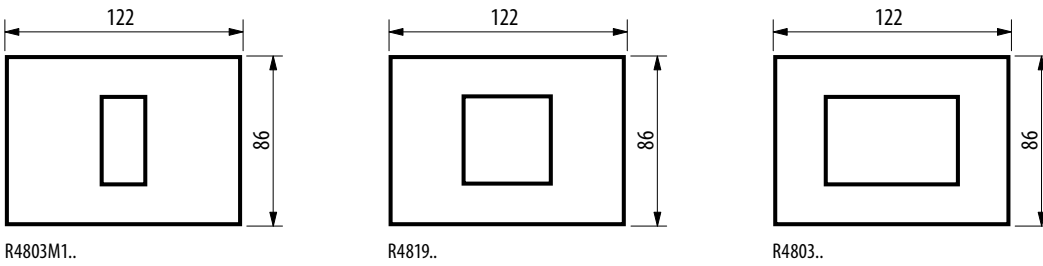

LIVINGLIGHT ÇERÇEVELER

Dikdörtgen çerçeveler

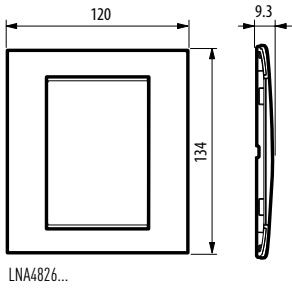
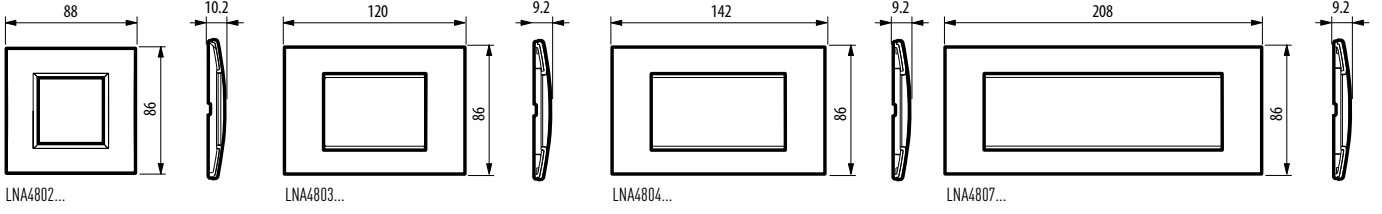

71 mm Merkez aralığı - Yatay/Dikey

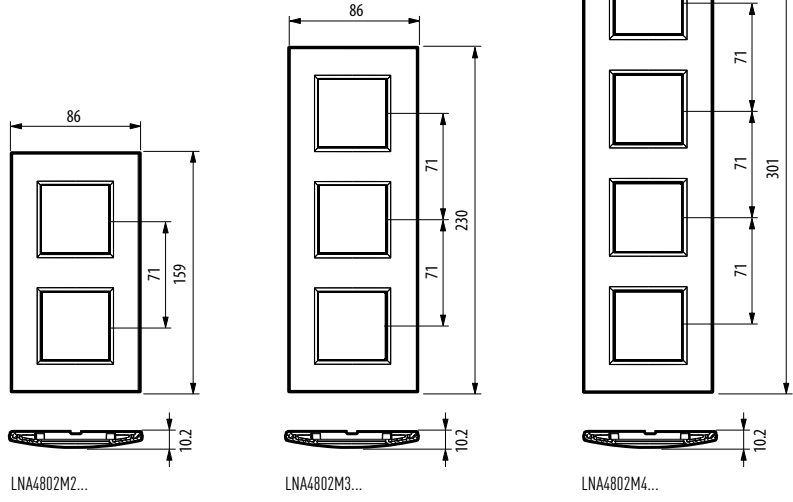

LIVINGLIGHT AIR çerçeveler (Modüler sistem)

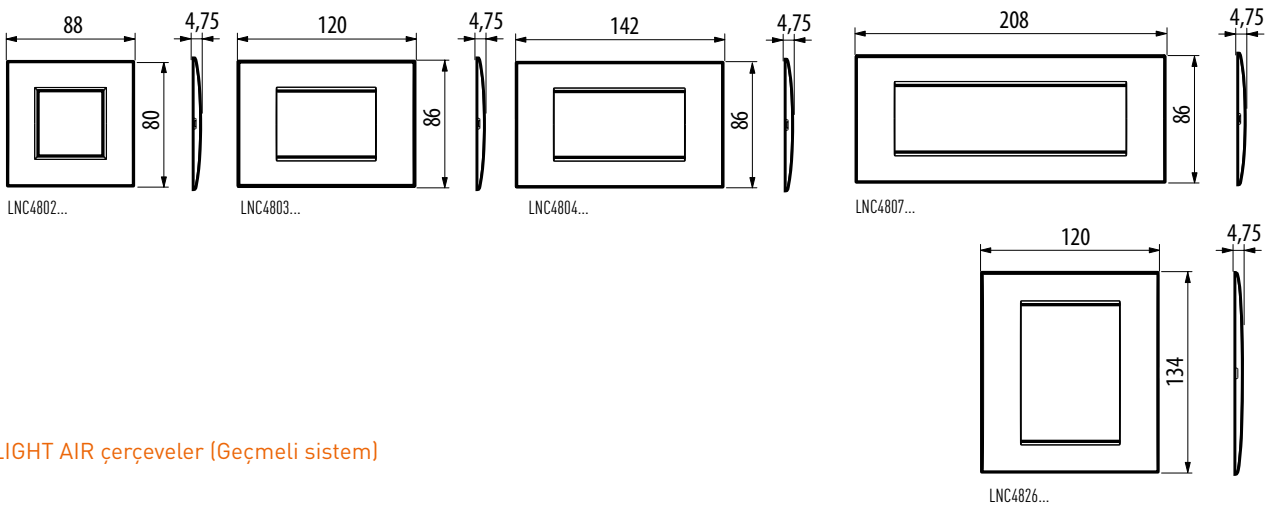

LIVINGLIGHT AIR çerçeveler (Geçmeli sistem)

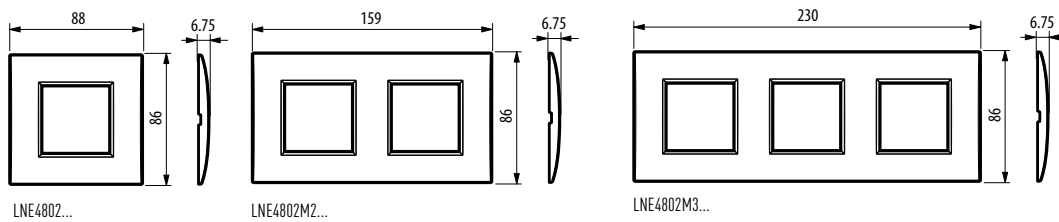

LIVINGLIGHT ÇERÇEVELER

Living international çerçeveler

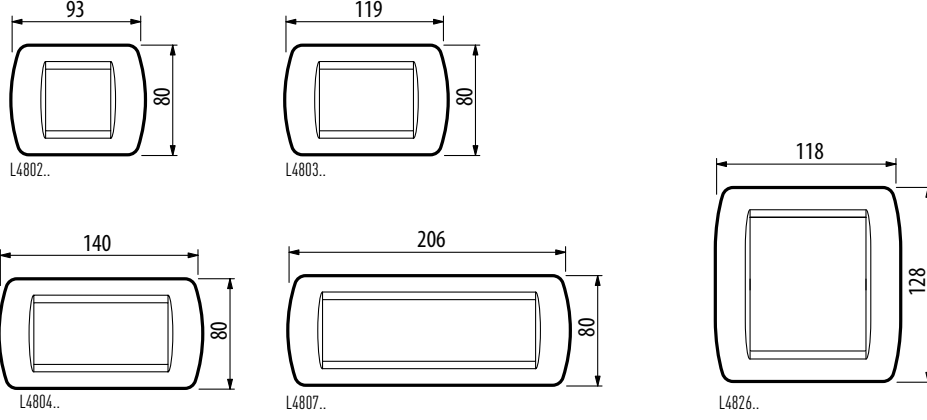

LIVINGLIGHT BUATLAR

Livinglight siva üstü buatlar

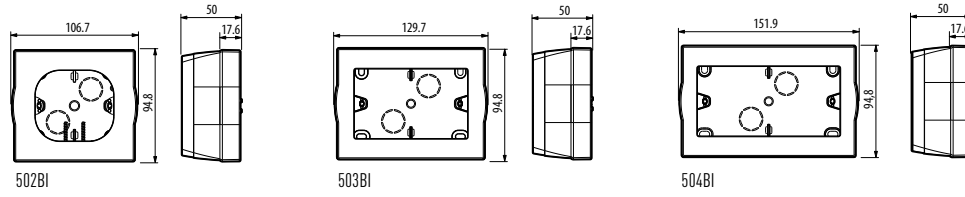

Sıva altı buatlar (2 modül AIR çerçeveler için)

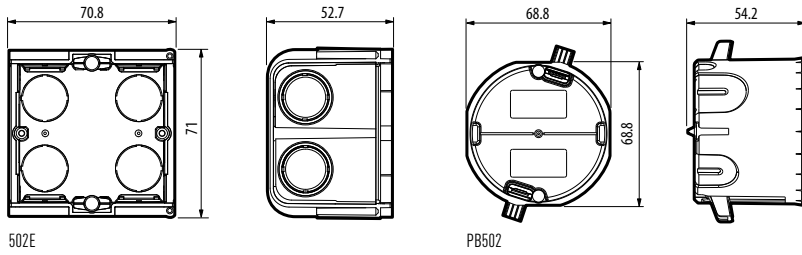

Living international siva üstü buatlar

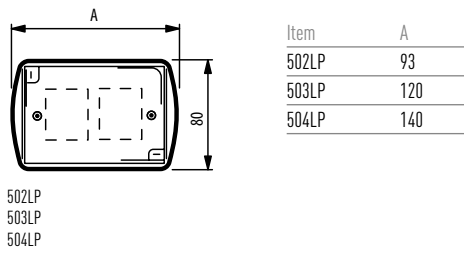

LIVINGLIGHT KAİDELER

LIVINGLIGHT AIR KAİDELER
MODÜLER SİSTEM

2 MODÜL KAİDE

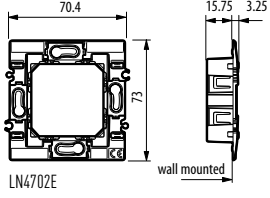

LN4702E

GEÇMELİ SİSTEM

2 MODÜL KAİDE

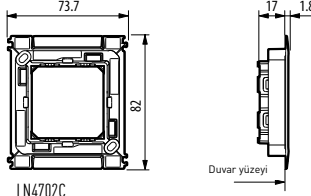

LN4702C

3 MODÜL KAİDE

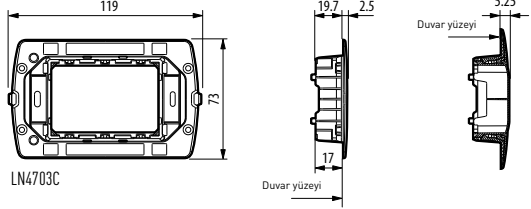

LN4703C

4 MODÜL KAİDE

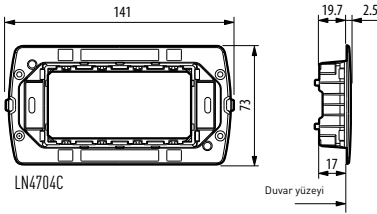

LN4704C

7 MODÜL KAİDE

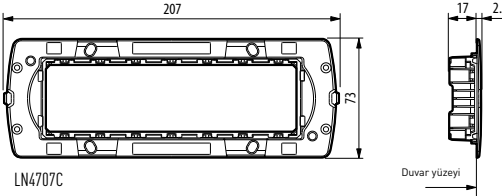

LN4707C

3+3 MODÜL KAİDE

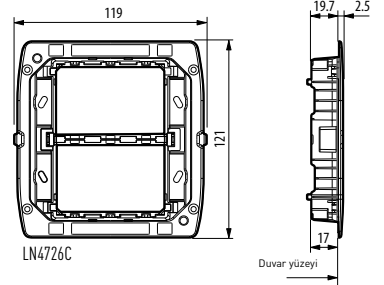

LN4726C

LIVINGLIGHT VE LIVING INTERNATIONAL KAİDELER

2 MODÜL KAİDE

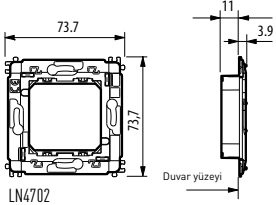

LN4702

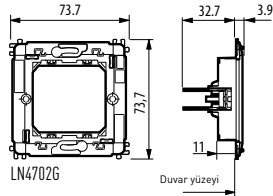

LN4702G

3 MODÜL KAİDE

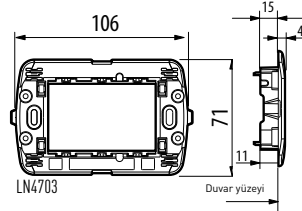

LN4703

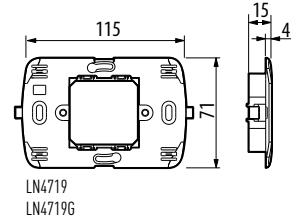

LN4719
LN4719G

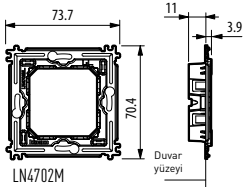

LN4702M

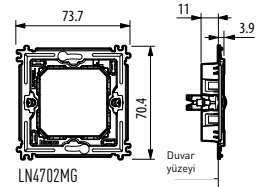

LN4702MG

4 MODÜL KAİDE

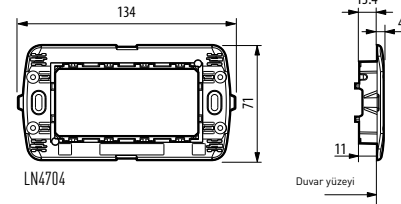

LN4704

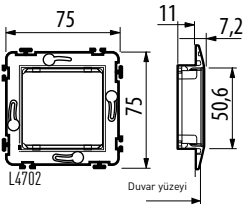

L4702

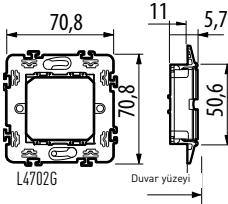

L4702G

3+3 MODÜL KAİDE

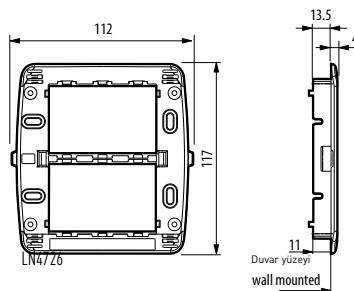

LN4726

7 MODÜL KAİDE

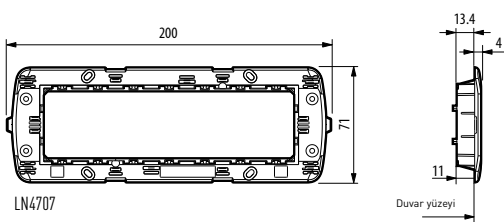

LN4707

AXOLUTE ÇERÇEVELER

AXOLUTE AIR ÇERÇEVELER

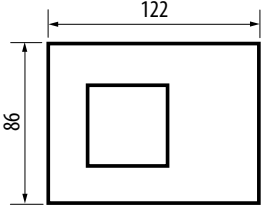

HW4819...

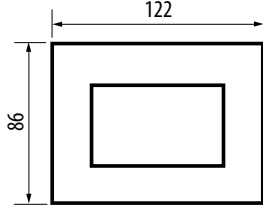

HW4803...

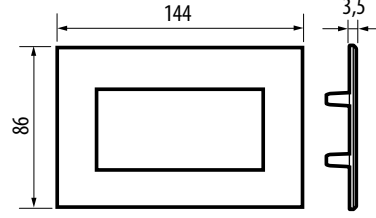

HW4804...

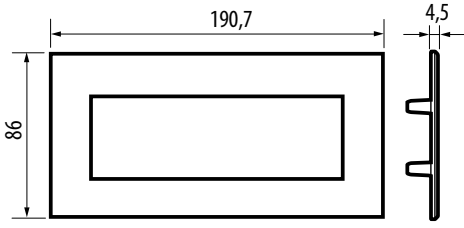

HW4806...

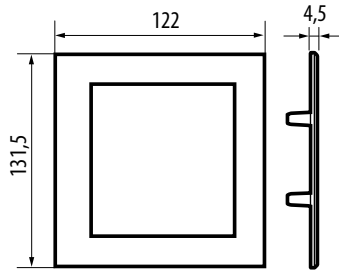

HW4826...

AXOLUTE AIR KAİDELER

2 E 3 MODÜL

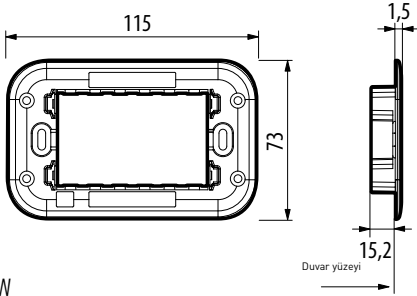

H4703W

4 MODÜL KAİDE

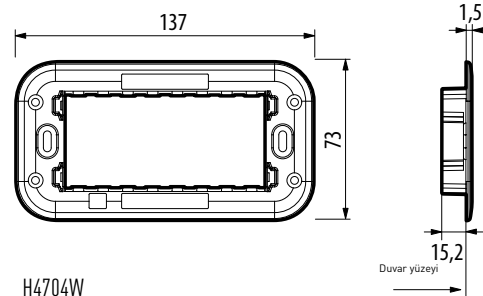

H4704W

6 MODÜL KAİDE

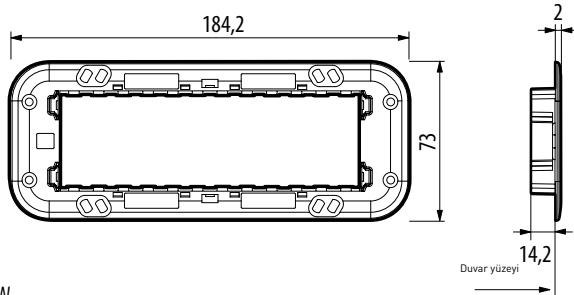

H4706W

3+3 MODÜL KAİDE

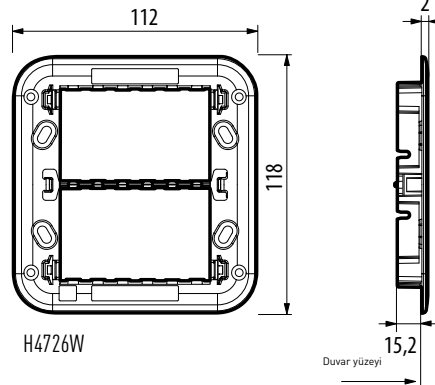

H4726W

LIVING NOW ÇERÇEVELER (MODÜLER SİSTEM)

LIVING NOW KAİDELER (MODÜLER SİSTEM)

2 MODÜL ÇERÇEVE

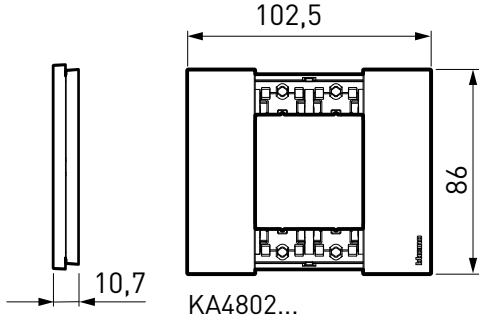

2 MODÜL KAİDE

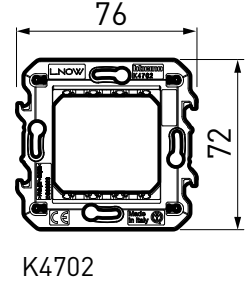

3 MODÜL ÇERÇEVE

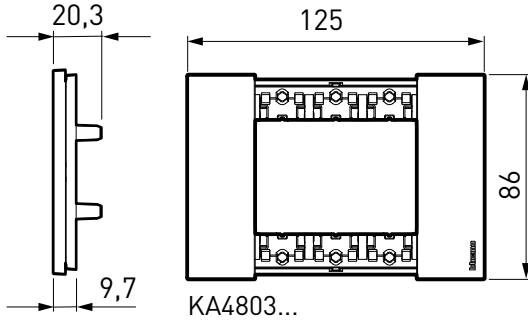

3 MODÜL KAİDE

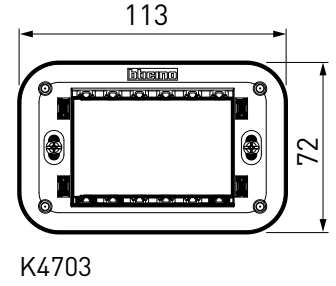

4 MODÜL ÇERÇEVE

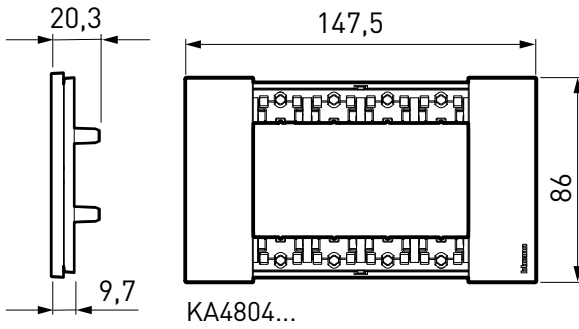

4 MODÜL KAİDE

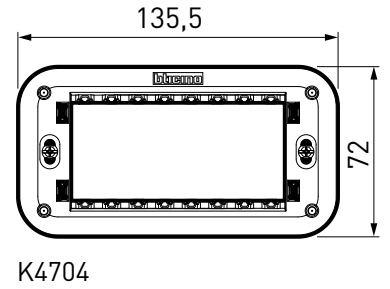

6 MODÜL ÇERÇEVE

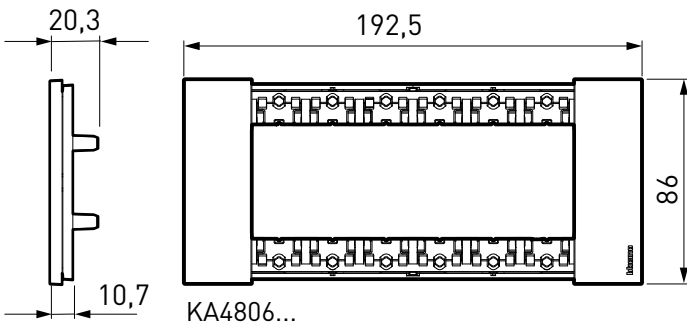

6 MODÜL KAİDE

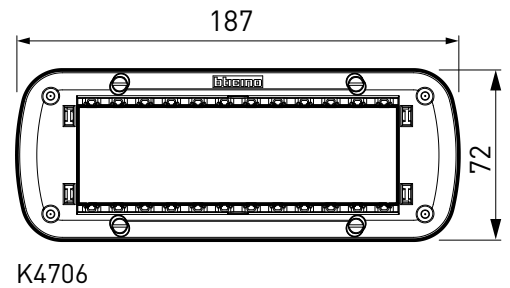

LIVING NOW ÇERÇEVELER (GEÇMELİ SİSTEM)

LIVING NOW KAİDELER (GEÇMELİ SİSTEM)

2 MODÜL ÇERÇEVE

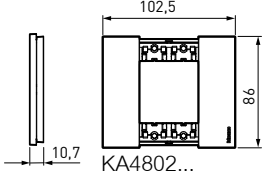

2 MODÜL KAİDE

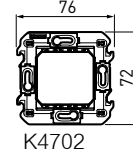

2+2 MODÜL ÇERÇEVE

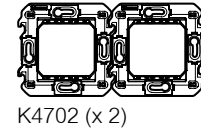
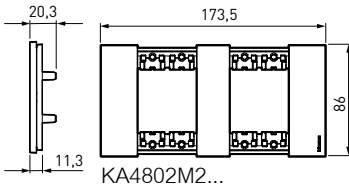

2+2+2 MODÜL ÇERÇEVE

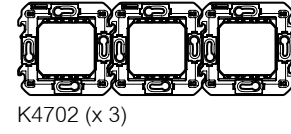
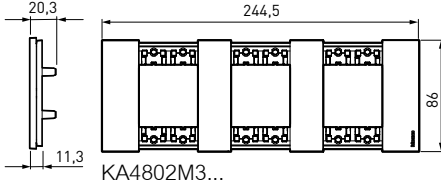

2+2+2+2 MODÜL ÇERÇEVE

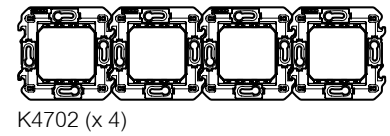
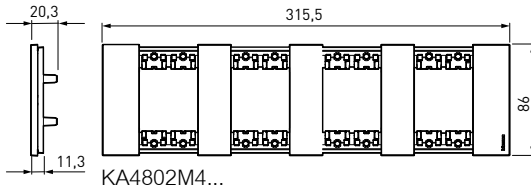

POŞETLİ PAKETLEME

- Birkaç dilde güvenlik bilgisi
- Tek üründe Ean kodu
- Ambalaj geri dönüşümü için bilgi
- Teknik bilgiler için QR kodu

**KUTULU PAKETLEME**

- Birkaç dilde güvenlik bilgisi
- Kutunun üzerinde Ean kodu



bticino.com.tr

Bticino 2024 Satış Şartları

SİPARİŞLER

- Komple ambalaj şeklindedir.
- Malın teslim tarihinden itibaren 4 gün içinde yapılmayan itirazlar dikkate alınmaz.
- Siparişlere, teslim anında yürürlükte olan sirküler ve fiyatlar uygulanır.
- Siparişler doğrudan toptancının fatura adresi veya deposuna sevk edilir.

SATIŞ İSKONTO

- 2024 yılı satış şartları geçerlidir.
- Daha fazla bilgi için satış ofislerimize danışınız.

ÖDEMELER

Ödeme Süresi:

- Fiyatlarımız teslim adresi esasına göre tespit edilmiş olup, KDV dahil değildir.
- Ödemelerde fatura tarihi esas alınır.
- Son fatura tutarı 21 gün içinde ödenmeden yeni verilen siparişler işleme konmaz ve herhangi bir teslimat yapılmaz.

Ödeme Şekli:

- Ödeme şekli konusunda satış bölümünün mutabakatı gereklidir.

NAKİT İSKONTOSU

- Fatura tarihi ile ödeme tarihi arasında kalan zamana bağlı olarak tespit edilen nakit iskonto oranı 2024 yılı satış şartlarında veya daha sonra yayınlanmış duyurularda belirlenmiştir.





SATIŞ İADELERİ

- Satış direktörünün onayı gerekmektedir.
- Navlun masrafı müşteriye aittir.

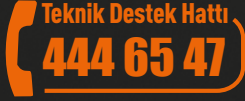
Legrand Elektrik San. A.Ş. önceden haber vermeksizin katalog ve fiyat listesinde bulunan ürünlerin teknik özelliklerinde ve fiyatlarında değişiklik yapma, satıştan çekme hakkını saklı tutar.

Genel Müdürlük
34776 Esenşehir Mah. Hale Sk. No:6/1 Ümraniye - İstanbul
Tel : (212) 368 28 00 (pbx)
: (212) 251 34 30
Faks : (216) 621 66 29
: (216) 622 55 50
e-posta : info.turkiye@legrand.com.tr



-  www.bticino.com.tr
-  instagram.com/bticino_turkiye
-  facebook.com/BticinoTurkey
-  linkedin.com/company/bticinoturkiye

Bölge Müdürlükleri

Genel Müdürlük

Esenşehir Mah. Hale Sk. No:6/1
34776 Ümraniye - İSTANBUL
Tel : (212) 368 28 00 (pbx)
: (212) 251 34 30
Faks : (216) 621 66 29
: (216) 622 55 50

Ankara Bölge Müdürlüğü

Timko İşyerleri Sitesi, Çamlıca
Mahallesi Anadolu Bulvarı No:
20/A-11 Merkez
06560 Yenimahalle - ANKARA
Tel : (312) 310 92 14
: (312) 310 82 15
Faks : (312) 312 28 88

Bursa Bölge Müdürlüğü

Üçevler mah. Bayraktepe sok.
Akay İş Merkezi No: 7 D: 5
16120 Nilüfer - BURSA
Tel : (224) 443 28 00
Faks : (224) 443 01 05

Ege Bölge Müdürlüğü

1203/11 sokak No:5-7 Megapol
Çarşı Kule, K:14 D:149
Halkapınar Mah.
35170 Konak/ İzmir
Tel : (232) 469 23 33
Faks : (232) 469 26 66

Adana irtibat

GSM : (533) 968 16 91

Antalya irtibat

Tel : (232) 469 23 33
GSM : (549) 748 83 54
Faks : (232) 469 26 66

Eskişehir irtibat

GSM : (549) 748 88 05

Diyarbakır irtibat

GSM : (533) 968 16 79

Kayseri-Konya irtibat

GSM : (549) 748 87 92

Trabzon- Samsun irtibat

GSM : (549) 748 83 73

