



Global Leader
Building a better future



HYUNDAI
ELECTRIC



FİYAT LİSTESİ

MART 2023



DANIŞMA
HATTI

0212
221 11 46

www.hyundai-electric.com.tr

TYPE APPROVAL CERTIFICATE

DNV-GL

This is to certify that the undernoted product(s) has/have been tested in accordance with the relevant requirements of the DNV GL Type Approval System.

Certificate No. **13 895 - 15 HH**

Company **Hyundai Heavy Industries Co., Ltd.
Electro-Electric Systems
1000 Bangeojinsanhwan-doro Dong-gu
Ulsan, 682-792, REPUBLIC OF KOREA**

Product Description **Moulded Case Circuit Breaker**

Type **HGM 100E/S/H/L, HGM 60E/S/H/L, HGM 50E/S/H/L, HGM 30E/S/H/L**

Environmental Category **C**

Technical Data / Range of Application
Number of Poles : 2P, 3P and 4P (unprotected N pole)
Protected Pole : 2 or 3
Rated frequency : 50 / 60 Hz
Rated operational Voltage (Ue) : 220 / 240 / 380 / 415 / 440 / 460 VAC
Rated insulation Voltage (Ui) : 1000 VAC
Rated impulse withstand Voltage (Uimp) : 8 kV
Rated short-circuit-capacity : see pages 2
Rated current (In) (40°) 100 series : 15A up to 100A
60 series : 15A up to 63A
50 series : 15A up to 50A
30 series : 15A up to 32A
Rated operational current (Ia) : 0,8 - 1,0 In or fixed
Type of release : Thermo-magnetic
Circuit Breaker for use in IT systems : Suitable
Utilization Category : A
Suitable for Insulation : Suitable
Method of Mounting : Fixed

Test Standard **Guidelines for the Performance of Type Approvals, Chapter 2- Test Requirements for Electrical / Electronic Equipment and Systems (VI-7-2), Edition 2012, IEC60947-2(Ed.4)am1,am2**

Documents **Test report : IECCE CB Scheme NL-29943 dated 2014-01-24
Ontech R142R-029 dated 2014-02-18
Ontech R143R-020 dated 2014-03-11**

Remarks **This certificate is issued on the basis of GL Guidelines for the Performance of Type Approvals, Chapter 1 - Procedure (VI-7-1), Edition 2007.**

Valid until **2020-02-04**
Page **1 of 2**
File No. **I.K.01**
Hamburg, **2015-02-05**

DNV GL

www.dnvgl.com

Type Approval Symbol 

Arne Schaarmann

Harald Amberg

TYPE APPROVAL CERTIFICATE

DNV-GL

This is to certify that the undernoted product(s) has/have been tested in accordance with the relevant requirements of the DNV GL Type Approval System.

Certificate No. **13 897 - 15 HH**

Company **Hyundai Heavy Industries Co., Ltd.
Electro-Electric Systems
1000 Bangeojinsanhwan-doro Dong-gu
Ulsan, 682-792, REPUBLIC OF KOREA**

Product Description **Moulded Case Circuit Breaker**

Type **HGM 250E/S/H/L, HGM 160E/S/H/L**

Environmental Category **C**

Technical Data / Range of Application
Number of Poles : 2P, 3P and 4P (unprotected N pole)
Protected Pole : 2 or 3
Rated frequency : 50 / 60 Hz
Rated operational Voltage (Ue) : 220 / 240 / 380 / 415 / 440 / 460 VAC
Rated insulation Voltage (Ui) : 1000 VAC
Rated impulse withstand Voltage (Uimp) : 8 kV
Rated short-circuit-capacity : see pages 2
Rated current (In) (40°) 250 series : 100A up to 250A
160 series : 100A up to 160A
Rated operational current (Ia) : 0,8 - 1,0 In or fixed
Type of release : Thermo-magnetic
Circuit Breaker for use in IT systems : Suitable
Utilization Category : A
Suitable for Insulation : Suitable
Method of Mounting : Fixed

Test Standard **Guidelines for the Performance of Type Approvals, Chapter 2- Test Requirements for Electrical / Electronic Equipment and Systems (VI-7-2), Edition 2012, IEC60947-2(Ed.4)am1,am2**

Documents **Test report : IECCE CB Scheme NL-26294 dated 2013-05-09
Ontech R142R-032 dated 2014-02-18
Ontech R143R-033 dated 2014-03-11**

Remarks **This certificate is issued on the basis of GL Guidelines for the Performance of Type Approvals, Chapter 1 - Procedure (VI-7-1), Edition 2007.**

Valid until **2020-02-04**
Page **1 of 2**
File No. **I.K.01**
Hamburg, **2015-02-05**

DNV GL

www.dnvgl.com

Type Approval Symbol 

Arne Schaarmann

Harald Amberg

TYPE APPROVAL CERTIFICATE

DNV-GL

This is to certify that the undernoted product(s) has/have been tested in accordance with the relevant requirements of the DNV GL Type Approval System.

Certificate No. **13 899 - 15 HH**

Company **Hyundai Heavy Industries Co., Ltd.
Electro-Electric Systems
1000 Bangeojinsanhwan-doro Dong-gu
Ulsan, 682-792, REPUBLIC OF KOREA**

Product Description **Moulded Case Circuit Breaker**

Type **HGM 630F/N/E/S/H/L, HGM 800F/N/E/S/H/L**

Environmental Category **C**

Technical Data / Range of Application
Number of Poles : 2P, 3P and 4P (unprotected N pole)
Protected Pole : 2 or 3
Rated frequency : 50 / 60 Hz
Rated operational Voltage (Ue) : 220 / 240 / 380 / 415 / 440 / 460 VAC
Rated insulation Voltage (Ui) : 1000 VAC
Rated impulse withstand Voltage (Uimp) : 8 kV
Rated short-circuit-capacity : see pages 2
Rated current (In) (40°) 800 series : 700A, 800A
630 series : 500A, 630A
Rated operational current (Ia) : 0,63 - 1,0 In or fixed
Type of release : Thermo-magnetic
Circuit Breaker for use in IT systems : Suitable
Utilization Category : A
Suitable for Insulation : Suitable
Method of Mounting : Fixed

Test Standard **Guidelines for the Performance of Type Approvals, Chapter 2- Test Requirements for Electrical / Electronic Equipment and Systems (VI-7-2), Edition 2012, IEC60947-2(Ed.4)am1,am2**

Documents **Test report : IECCE CB Scheme NL-32141 dated 2014-08-21
Ontech R149R-037 dated 2014-09-17
Ontech R149R-013 dated 2014-11-11**

Remarks **This certificate is issued on the basis of GL Guidelines for the Performance of Type Approvals, Chapter 1 - Procedure (VI-7-1), Edition 2007.**

Valid until **2020-02-04**
Page **1 of 2**
File No. **I.K.01**
Hamburg, **2015-02-05**

DNV GL

www.dnvgl.com

Type Approval Symbol 

Arne Schaarmann

Harald Amberg

TYPE APPROVAL CERTIFICATE

DNV-GL

This is to certify that the undernoted product(s) has/have been tested in accordance with the relevant requirements of the DNV GL Type Approval System.

Certificate No. **13 900 - 15 HH**

Company **Hyundai Heavy Industries Co., Ltd.
Electro-Electric Systems
1000 Bangeojinsanhwan-doro Dong-gu
Ulsan, 682-792, REPUBLIC OF KOREA**

Product Description **Moulded Case Circuit Breaker**

Type **UPB 160D F/N/S/H/L/X, UPB 125D F/N/S/H/L/X, UPB 50D F/N/S/H/L/X
HGP 160D F/N/S/H/L/X, HGP 125D F/N/S/H/L/X, HGP 50D F/N/S/H/L/X**

Environmental Category **C**

Technical Data / Range of Application
Number of Poles : 2P, 3P and 4P (unprotected N pole)
Protected Pole : 2 or 3
Rated frequency : 50 / 60 Hz
Rated operational Voltage (Ue) : 380 / 415 / 440 / 460 VAC
Rated insulation Voltage (Ui) : 1000 VAC
Rated impulse withstand Voltage (Uimp) : 8 kV
Rated short-circuit-capacity : see pages 2
Rated current (In) (40°) 160 series : 100A up to 160A
125 series : 15A up to 125A
50 series : 15A up to 50A
Rated operational current (Ia) : 0,8 - 1,0 In or fixed
Type of release : Thermo-magnetic
Circuit Breaker for use in IT systems : Suitable
Utilization Category : A
Suitable for Insulation : Suitable
Method of Mounting : Fixed

Test Standard **Guidelines for the Performance of Type Approvals, Chapter 2- Test Requirements for Electrical / Electronic Equipment and Systems (VI-7-2), Edition 2012, IEC60947-2(Ed.4)am1,am2**

Documents **Test report : IECCE CB Scheme NL-32380 dated 2014-09-05
Ontech R149R-034 dated 2014-09-17
Ontech R149R-010 dated 2014-11-11**

Remarks **This certificate is issued on the basis of GL Guidelines for the Performance of Type Approvals, Chapter 1 - Procedure (VI-7-1), Edition 2007.**

Valid until **2020-02-04**
Page **1 of 2**
File No. **I.K.01**
Hamburg, **2015-02-05**

DNV GL

www.dnvgl.com

Type Approval Symbol 

Arne Schaarmann

Harald Amberg

Hyundai Electric Türkiye,

Ruha Elektrik A.Ş. 2003 yılından günümüze Hyundai Electric Türkiye distribütörlüğünü yapmakta ve Türkiye’de elektrik ve enerji sektörüne yön veren firmaların arasında yer almaktadır.

Kuruluşundan bu yana çok hızlı bir büyüme trendine sahip olan Ruha Elektrik A.Ş. 2015 yılında TOBB tarafından belirlenen Türkiye’nin en hızlı büyüyen şirketleri arasında 5. olma başarısını elde etmiştir. Aynı yıl dünyanın en saygın ekonomi dergilerinden Fortune Dergisinin yayımladığı ve Türkiye’nin en büyük 500 şirketinin yer aldığı listede yer alarak sektördeki gücünü ispatlamış durumdadır.

Dünyanın en seçkin ekonomi & finans dergilerinden biri olan Fortune’un yayınladığı “Türkiye’nin En Büyük 500 Şirketi” sıralamasında Ruha Elektrik A.Ş. 2015 yılından bu yana yer almaktadır. 2015 yılında listeye 396. sıradan giren şirketimiz ilerleyen yıllarda sırasıyla 320,317,271,240 ve son olarak geçtiğimiz yılda 230. sıraya yükselmiştir. Bu liste; başarımızın her geçen yıl ivmelenerek arttığını tescilleyen övünç kaynağımız olmuştur. Bu başarılarla karşı kayıtsız kalmayan Hyundai Electric, Türkiye’de Ruha Elektrik ile ortak üretim yapma anlaşması imzalayıp kamuoyuna duyurmuştur.

Bu doğrultuda İstanbul Silivri’de 40.000 m²’lik tesisi üretime hazır hale getiren Ruha Elektrik A.Ş., Hyundai ürünlerini Türkiye’de üretilen başta bölge ülkeleri olmak üzere Rusya, Ortadoğu ve Avrupa’ya satmayı hedefliyor. Ayrıca Hyundai ile olan 20 yıllık birlikteliğin böylesine büyük bir yatırım ile taçlanması da ülkemiz adına ayrı bir övünç kaynağı olmuştur.

“Daha iyi bir gelecek inşa ediyoruz”



Global Leader
Building a better future



HG SERİSİ ürün ailesi.



İÇİNDEKİLER

	Otomatik Sigortalar 05-11		HGM/HGE Serisi Kompakt Şalter Aksesuarları 30
	Kaçak Akım Koruma Şalterleri 12		HGE Serisi Kaçak Akım Korumalı Kompakt Şalterler 31
	Modüler Kontaktörler 13		HGP Serisi, Yüksek Kesme Kapasiteli Kompakt Şalterler 32
	Kontaktörler 15		HGP Serisi, Kompakt Şalter Aksesuarları 33
	DC ve 4 Kutuplu Kontaktörler 16		HGN / HGS Açık Tip Güç Şalterleri 35-37
	Kompanzasyon Kontaktörleri ve Yardımcı Kontaktörler 17		HGN / HGS Açık Tip Şalter Aksesuar ve Yedek Parçalar 38
	Kontaktör Aksesuarları ve Yedek Parçalar 18-19		Vakumlu Kontaktör 40
	Termik Röleler 20		Vakumlu Devre Kesici 41
	Motor Koruma Şalterleri 21		Pratik Seçim Cetvelleri 42
	UCB Serisi Kompakt Şalterler 23-24		Kontaktör Ölçüleri 43-45
	UCB Serisi Kompakt Şalter Aksesuarları 25-26		Kompakt Ölçüleri 46-49
	HGM Serisi Kompakt Şalter 27-29		Sertifikalar 50-52

OTOMATİK SİGORTALAR

3KA - 6KA - 10KA



1 KUTUPLU



2 KUTUPLU



3 KUTUPLU



4 KUTUPLU

KAÇAK AKIM KORUMA ŞALTERLERİ



2 KUTUPLU
30-300 MA



4 KUTUPLU
30-300 MA

1 Kutuplu, 3 kA, B Eğrisi

Ürün Kodu	Anma Akımı (A)	Koruma Tipi	Min. Sip. Adedi	Birim Fiyat (\$)
HİBD 63E 1P/6-B	6	TM	12	3,51
HİBD 63E 1P/10-B	10	TM	12	2,89
HİBD 63E 1P/16-B	16	TM	12	2,89
HİBD 63E 1P/20-B	20	TM	12	2,89
HİBD 63E 1P/25-B	25	TM	12	2,89
HİBD 63E 1P/32-B	32	TM	12	2,89
HİBD 63E 1P/40-B	40	TM	12	3,10
HİBD 63E 1P/50-B	50	TM	12	3,30
HİBD 63E 1P/63-B	63	TM	12	3,92



1 Kutuplu, 3 kA, C Eğrisi

Ürün Kodu	Anma Akımı (A)	Koruma Tipi	Min. Sip. Adedi	Birim Fiyat (\$)
HİBD 63E 1P/1-C	1	TM	12	3,51
HİBD 63E 1P/2-C	2	TM	12	3,51
HİBD 63E 1P/3-C	3	TM	12	3,51
HİBD 63E 1P/4-C	4	TM	12	3,51
HİBD 63E 1P/6-C	6	TM	12	3,51
HİBD 63E 1P/10-C	10	TM	12	2,89
HİBD 63E 1P/16-C	16	TM	12	2,89
HİBD 63E 1P/20-C	20	TM	12	2,89
HİBD 63E 1P/25-C	25	TM	12	2,89
HİBD 63E 1P/32-C	32	TM	12	2,89
HİBD 63E 1P/40-C	40	TM	12	3,10
HİBD 63E 1P/50-C	50	TM	12	3,30
HİBD 63E 1P/63-C	63	TM	12	3,92

3 Kutuplu, 3 kA, C Eğrisi

Ürün Kodu	Anma Akımı (A)	Koruma Tipi	Min. Sip. Adedi	Birim Fiyat (\$)
HİBD 63E 3P/1-C	1	TM	12	11,57
HİBD 63E 3P/2-C	2	TM	12	11,57
HİBD 63E 3P/3-C	3	TM	12	11,57
HİBD 63E 3P/4-C	4	TM	12	11,57
HİBD 63E 3P/6-C	6	TM	12	10,42
HİBD 63E 3P/10-C	10	TM	12	8,69
HİBD 63E 3P/16-C	16	TM	12	8,69
HİBD 63E 3P/20-C	20	TM	12	8,69
HİBD 63E 3P/25-C	25	TM	12	8,69
HİBD 63E 3P/32-C	32	TM	12	9,66
HİBD 63E 3P/40-C	40	TM	12	10,80
HİBD 63E 3P/50-C	50	TM	12	11,57
HİBD 63E 3P/63-C	63	TM	12	12,14





1 Kutuplu, 6 kA, C Eğrisi

Ürün Kodu	Anma Akımı (A)	Koruma Tipi	Min. Sip. Adedi	Birim Fiyat (\$)
HİBD 63N 1P/1A-C	1	TM	12	4,09
HİBD 63N 1P/2A-C	2	TM	12	4,09
HİBD 63N 1P/3A-C	3	TM	12	4,09
HİBD 63N 1P/4A-C	4	TM	12	4,09
HİBD 63N 1P/5A-C	5	TM	12	4,09
HİBD 63N 1P/6A-C	6	TM	12	3,70
HİBD 63N 1P/10A-C	10	TM	12	3,28
HİBD 63N 1P/16A-C	16	TM	12	3,28
HİBD 63N 1P/20A-C	20	TM	12	3,28
HİBD 63N 1P/25A-C	25	TM	12	3,28
HİBD 63N 1P/32A-C	32	TM	12	3,49
HİBD 63N 1P/40A-C	40	TM	12	4,09
HİBD 63N 1P/50A-C	50	TM	12	5,12
HİBD 63N 1P/63A-C	63	TM	12	5,80



2 Kutuplu, 6 kA, C Eğrisi

Ürün Kodu	Anma Akımı (A)	Koruma Tipi	Min. Sip. Adedi	Birim Fiyat (\$)
HİBD 63N 2P/1A-C	1	TM	6	10,80
HİBD 63N 2P/2A-C	2	TM	6	10,80
HİBD 63N 2P/4A-C	4	TM	6	10,80
HİBD 63N 2P/6A-C	6	TM	6	9,26
HİBD 63N 2P/10A-C	10	TM	6	9,26
HİBD 63N 2P/16A-C	16	TM	6	9,26
HİBD 63N 2P/20A-C	20	TM	6	9,26
HİBD 63N 2P/25A-C	25	TM	6	9,26
HİBD 63N 2P/32A-C	32	TM	6	10,60
HİBD 63N 2P/40A-C	40	TM	6	10,80
HİBD 63N 2P/50A-C	50	TM	6	11,57
HİBD 63N 2P/63A-C	63	TM	6	12,34



3 Kutuplu, 6 kA, C Eğrisi

Ürün Kodu	Anma Akımı (A)	Koruma Tipi	Min. Sip. Adedi	Birim Fiyat (\$)
HİBD 63N 3P/1A-C	1	TM	4	13,31
HİBD 63N 3P/2A-C	2	TM	4	13,31
HİBD 63N 3P/4A-C	4	TM	4	13,31
HİBD 63N 3P/5A-C	5	TM	4	13,31
HİBD 63N 3P/6A-C	6	TM	4	11,97
HİBD 63N 3P/10A-C	10	TM	4	12,34
HİBD 63N 3P/16A-C	16	TM	4	12,34
HİBD 63N 3P/20A-C	20	TM	4	12,34
HİBD 63N 3P/25A-C	25	TM	4	12,34
HİBD 63N 3P/32A-C	32	TM	4	13,11
HİBD 63N 3P/40A-C	40	TM	4	14,08
HİBD 63N 3P/50A-C	50	TM	4	15,83
HİBD 63N 3P/63A-C	63	TM	4	17,37



4 Kutuplu, 6 kA, C Eğrisi

Ürün Kodu	Anma Akımı (A)	Koruma Tipi	Min. Sip. Adedi	Birim Fiyat (\$)
HİBD 63N 4P/1A-C	1	TM	3	18,32
HİBD 63N 4P/2A-C	2	TM	3	18,32
HİBD 63N 4P/4A-C	4	TM	3	18,32
HİBD 63N 4P/6A-C	6	TM	3	17,37
HİBD 63N 4P/10A-C	10	TM	3	16,40
HİBD 63N 4P/16A-C	16	TM	3	16,40
HİBD 63N 4P/20A-C	20	TM	3	16,40
HİBD 63N 4P/25A-C	25	TM	3	16,40
HİBD 63N 4P/32A-C	32	TM	3	16,78
HİBD 63N 4P/40A-C	40	TM	3	18,32
HİBD 63N 4P/50A-C	50	TM	3	19,28
HİBD 63N 4P/63A-C	63	TM	3	22,76



1+N Kutuplu, 6 kA, C Eğrisi

Ürün Kodu	Anma Akımı (A)	Koruma Tipi	Min. Sip. Adedi	Birim Fiyat (\$)
HİBD 63N 1NP/1A-C	1	TM	6	9,26
HİBD 63N 1NP/2A-C	2	TM	6	9,26
HİBD 63N 1NP/4A-C	4	TM	6	9,26
HİBD 63N 1NP/6A-C	6	TM	6	7,72
HİBD 63N 1NP/10A-C	10	TM	6	7,72
HİBD 63N 1NP/16A-C	16	TM	6	7,72
HİBD 63N 1NP/20A-C	20	TM	6	7,72
HİBD 63N 1NP/25A-C	25	TM	6	7,72
HİBD 63N 1NP/32A-C	32	TM	6	8,48
HİBD 63N 1NP/40A-C	40	TM	6	9,26
HİBD 63N 1NP/50A-C	50	TM	6	11,57
HİBD 63N 1NP/63A-C	63	TM	6	12,74



3+N Kutuplu, 6 kA, C Eğrisi

Ürün Kodu	Anma Akımı (A)	Koruma Tipi	Min. Sip. Adedi	Birim Fiyat (\$)
HİBD 63N 3NP/1A-C	1	TM	3	19,28
HİBD 63N 3NP/2A-C	2	TM	3	19,28
HİBD 63N 3NP/4A-C	4	TM	3	19,28
HİBD 63N 3NP/6A-C	6	TM	3	16,40
HİBD 63N 3NP/10A-C	10	TM	3	15,05
HİBD 63N 3NP/16A-C	16	TM	3	15,05
HİBD 63N 3NP/20A-C	20	TM	3	15,05
HİBD 63N 3NP/25A-C	25	TM	3	15,05
HİBD 63N 3NP/32A-C	32	TM	3	15,83
HİBD 63N 3NP/40A-C	40	TM	3	17,37
HİBD 63N 3NP/50A-C	50	TM	3	18,71
HİBD 63N 3NP/63A-C	63	TM	3	20,82

1 Kutuplu, 10 kA, C Eğrisi

Ürün Kodu	Anma Akımı (A)	Koruma Tipi	Min. Sip. Adedi	Birim Fiyat (\$)
HİBD 63H 1P/1A-C	1	TM	12	6,30
HİBD 63H 1P/2A-C	2	TM	12	6,30
HİBD 63H 1P/4A-C	4	TM	12	6,30
HİBD 63H 1P/6A-C	6	TM	12	5,49
HİBD 63H 1P/10A-C	10	TM	12	5,49
HİBD 63H 1P/16A-C	16	TM	12	5,49
HİBD 63H 1P/20A-C	20	TM	12	5,49
HİBD 63H 1P/25A-C	25	TM	12	5,49
HİBD 63H 1P/32A-C	32	TM	12	6,12
HİBD 63H 1P/40A-C	40	TM	12	6,52
HİBD 63H 1P/50A-C	50	TM	12	7,12
HİBD 63H 1P/63A-C	63	TM	12	7,73
HİBD 125 1P/80A-C	80	TM	8	19,94
HİBD 125 1P/100A-C	100	TM	8	21,97
HİBD 125 1P/125A-C	125	TM	8	24,42



2 Kutuplu, 10 kA, C Eğrisi

Ürün Kodu	Anma Akımı (A)	Koruma Tipi	Min. Sip. Adedi	Birim Fiyat (\$)
HİBD 63H 2P/1A-C	1	TM	6	13,51
HİBD 63H 2P/2A-C	2	TM	6	13,51
HİBD 63H 2P/4A-C	4	TM	6	13,51
HİBD 63H 2P/6A-C	6	TM	6	13,31
HİBD 63H 2P/10A-C	10	TM	6	12,54
HİBD 63H 2P/16A-C	16	TM	6	12,54
HİBD 63H 2P/20A-C	20	TM	6	12,54
HİBD 63H 2P/25A-C	25	TM	6	12,54
HİBD 63H 2P/32A-C	32	TM	6	13,51
HİBD 63H 2P/40A-C	40	TM	6	14,86
HİBD 63H 2P/50A-C	50	TM	6	15,83
HİBD 63H 2P/63A-C	63	TM	6	18,14
HİBD 125 2P/80A-C	80	TM	4	39,92
HİBD 125 2P/100A-C	100	TM	4	42,43
HİBD 125 2P/125A-C	125	TM	4	46,29



3 Kutuplu, 10 kA, C Eğrisi

Ürün Kodu	Anma Akımı (A)	Koruma Tipi	Min. Sip. Adedi	Birim Fiyat (\$)
HİBD 63H 3P/1A-C	1	TM	4	24,11
HİBD 63H 3P/2A-C	2	TM	4	24,11
HİBD 63H 3P/4A-C	4	TM	4	24,11
HİBD 63H 3P/6A-C	6	TM	4	19,28
HİBD 63H 3P/10A-C	10	TM	4	18,32
HİBD 63H 3P/16A-C	16	TM	4	18,32
HİBD 63H 3P/20A-C	20	TM	4	18,32
HİBD 63H 3P/25A-C	25	TM	4	18,32
HİBD 63H 3P/32A-C	32	TM	4	19,28
HİBD 63H 3P/40A-C	40	TM	4	20,25
HİBD 63H 3P/50A-C	50	TM	4	22,76
HİBD 63H 3P/63A-C	63	TM	4	25,85
HİBD 125 3P/80A-C	80	TM	2	57,48
HİBD 125 3P/100A-C	100	TM	2	62,29
HİBD 125 3P/125A-C	125	TM	2	69,43



4 Kutuplu, 10 kA, C Eğrisi

Ürün Kodu	Anma Akımı (A)	Koruma Tipi	Min. Sip. Adedi	Birim Fiyat (\$)
HİBD 63H 4P/1A-C	1	TM	3	32,20
HİBD 63H 4P/2A-C	2	TM	3	32,20
HİBD 63H 4P/4A-C	4	TM	3	32,20
HİBD 63H 4P/6A-C	6	TM	3	25,65
HİBD 63H 4P/10A-C	10	TM	3	24,49
HİBD 63H 4P/16A-C	16	TM	3	24,49
HİBD 63H 4P/20A-C	20	TM	3	24,49
HİBD 63H 4P/25A-C	25	TM	3	24,49
HİBD 63H 4P/32A-C	32	TM	3	25,65
HİBD 63H 4P/40A-C	40	TM	3	26,99
HİBD 63H 4P/50A-C	50	TM	3	30,28
HİBD 63H 4P/63A-C	63	TM	3	34,52
HİBD 125 4P/80A-C	80	TM	2	80,99
HİBD 125 4P/100A-C	100	TM	2	83,12
HİBD 125 4P/125A-C	125	TM	2	92,57

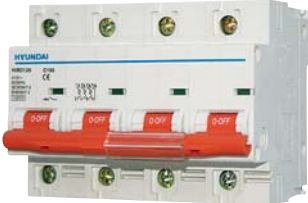

1+N Kutuplu, 10 kA, C Eğrisi



Ürün Kodu	Anma Akımı (A)	Koruma Tipi	Min. Sip. Adedi	Birim Fiyat (\$)
HİBD 63H 1NP/1A-C	1	TM	6	15,43
HİBD 63H 1NP/2A-C	2	TM	6	15,43
HİBD 63H 1NP/4A-C	4	TM	6	15,43
HİBD 63H 1NP/6A-C	6	TM	6	14,65
HİBD 63H 1NP/10A-C	10	TM	6	13,51
HİBD 63H 1NP/16A-C	16	TM	6	13,51
HİBD 63H 1NP/20A-C	20	TM	6	13,51
HİBD 63H 1NP/25A-C	25	TM	6	13,51
HİBD 63H 1NP/32A-C	32	TM	6	14,47
HİBD 63H 1NP/40A-C	40	TM	6	15,43
HİBD 63H 1NP/50A-C	50	TM	6	16,40
HİBD 63H 1NP/63A-C	63	TM	6	17,37
HİBD 125 1NP/80A-C	80	TM	4	40,51
HİBD 125 1NP/100A-C	100	TM	4	41,46
HİBD 125 1NP/125A-C	125	TM	4	44,36

3+N Kutuplu, 10 kA, C Eğrisi



Ürün Kodu	Anma Akımı (A)	Koruma Tipi	Min. Sip. Adedi	Birim Fiyat (\$)
HİBD 63H 3NP/1A-C	1	TM	3	28,93
HİBD 63H 3NP/2A-C	2	TM	3	28,93
HİBD 63H 3NP/4A-C	4	TM	3	28,93
HİBD 63H 3NP/6A-C	6	TM	3	23,14
HİBD 63H 3NP/10A-C	10	TM	3	22,18
HİBD 63H 3NP/16A-C	16	TM	3	22,18
HİBD 63H 3NP/20A-C	20	TM	3	22,18
HİBD 63H 3NP/25A-C	25	TM	3	22,18
HİBD 63H 3NP/32A-C	32	TM	3	23,14
HİBD 63H 3NP/40A-C	40	TM	3	24,31
HİBD 63H 3NP/50A-C	50	TM	3	27,39
HİBD 63H 3NP/63A-C	63	TM	3	31,25
HİBD 125 3NP/80A-C	80	TM	2	73,28
HİBD 125 3NP/100A-C	100	TM	2	75,22
HİBD 125 3NP/125A-C	125	TM	2	82,93

1 Kutuplu Otomat Tipi Anahtar, 415 V

Ürün Kodu	Çalışma Akımı (A)	Min. Sip Adedi	Birim Fiyat (\$)
HİSD 125,1P/16A	16	12	2,52
HİSD 125,1P/32A	32	12	2,52
HİSD 125,1P/63A	63	12	3,49
HİSD 125,1P/100A	100	12	17,37
HİSD 125,1P/125A	125	12	25,27



2 Kutuplu Otomat Tipi Anahtar, 415 V

Ürün Kodu	Çalışma Akımı (A)	Min. Sip Adedi	Birim Fiyat (\$)
HİSD 125,2P/16A	16	6	6,17
HİSD 125,2P/32A	32	6	6,75
HİSD 125,2P/63A	63	6	7,34
HİSD 125,2P/100A	100	6	20,06
HİSD 125,2P/125A	125	6	28,93

3 Kutuplu Otomat Tipi Anahtar, 415 V

Ürün Kodu	Çalışma Akımı (A)	Min. Sip Adedi	Birim Fiyat (\$)
HİSD 125,3P/16A	16	4	9,45
HİSD 125,3P/32A	32	4	10,42
HİSD 125,3P/63A	63	4	11,57
HİSD 125,3P/100A	100	4	30,09
HİSD 125,3P/125A	125	4	39,55



4 Kutuplu Otomat Tipi Anahtar, 415 V

Ürün Kodu	Çalışma Akımı (A)	Min. Sip Adedi	Birim Fiyat (\$)
HİSD 125,4P/16A	16	3	12,34
HİSD 125,4P/32A	32	3	14,86
HİSD 125,4P/63A	63	3	16,01
HİSD 125,4P/100A	100	3	38,96
HİSD 125,4P/125A	125	3	49,95

Otomatik Sigorta Aksesuarları

Yardımcı Kontak	Açıklama	Min. Sip. Adedi	Birim Fiyat (\$)
AUX-M63	HİBD63E-N-125 için yardımcı kontak (1NA+1NK)	12	11,57
AUX-M63H	HİBD63H için ani yardımcı kontak (1NA-1NK)	12	11,57



Alarm Kontakı

Ürün Kodu	Açıklama	Min. Sip. Adedi	Birim Fiyat (\$)
ALT-M63	HİBD63E-N-125 için alarm kontakı (1NA+1NK)	12	14,47
ALT-M63H	HİBD63H için alarm kontakı (1NA-1NK)	12	14,47

Açırma Bobini

Ürün Kodu	Açıklama	Min. Sip. Adedi	Birim Fiyat (\$)
SHT-M63/S5	HİBD63E-N-125 için açırma bobini (DC24)	8	28,93
SHT-M63/S2	HİBD63E-N-125 için açırma bobini (AC240)	8	28,93
SHT-M63/S4	HİBD63E-N-125 için açırma bobini (AC415)	8	28,93
SHT-M63H/S5	HİBD63H için açırma bobini (DC24)	8	28,93
SHT-M63H/S2	HİBD63H için açırma bobini (AC240)	8	28,93
SHT-M63H/S4	HİBD63H için açırma bobini (AC415)	8	28,93



Düşük Gerilim Bobinleri

Ürün Kodu	Açıklama	Min. Sip. Adedi	Birim Fiyat (\$)
UVT-I-M63-U2	HİBD63E-N-125 için düşük gerilim bobini (AC240)	12	32,79
UVT-I-M63H-U2	HİBD63H için düşük gerilim bobini (AC240)	12	32,79

2 Kutup 30 mA AC tip

Ürün Kodu	Anma Akımı (A)	Çalışma Voltajı (VAC)	Kesme Kapasitesi	Min. Sip. Adedi	Birim Fiyat (\$)
HİRC63-2P-030/25A	25	240-415	6	6	23,82
HİRC63-2P-030/32A	32	240-415	6	6	24,43
HİRC63-2P-030/40A	40	240-415	6	6	24,87
HİRC63-2P-030/63A	63	240-415	6	6	25,49
HİRC100-2P-030/80A	80	240-415	10	6	47,80
HİRC100-2P-030/100A	100	240-415	10	6	50,99



2 Kutuplu 300 mA AC tip

Ürün Kodu	Anma Akımı (A)	Çalışma Voltajı (VAC)	Kesme Kapasitesi	Min. Sip. Adedi	Birim Fiyat (\$)
HİRC63-2P-300/25A	25	240-415	6	6	23,82
HİRC63-2P-300/32A	32	240-415	6	6	24,43
HİRC63-2P-300/40A	40	240-415	6	6	24,87
HİRC63-2P-300/63A	63	240-415	6	6	25,49
HİRC100-2P-300/80A	80	240-415	10	6	47,80
HİRC100-2P-300/100A	100	240-415	10	6	50,99

4 Kutuplu 30 mA AC tip

Ürün Kodu	Anma Akımı (A)	Çalışma Voltajı (VAC)	Kesme Kapasitesi	Min. Sip. Adedi	Birim Fiyat (\$)
HİRC63-4P-030/25A	25	240-415	6	3	32,31
HİRC63-4P-030/32A	32	240-415	6	3	32,92
HİRC63-4P-030/40A	40	240-415	6	3	33,56
HİRC63-4P-030/63A	63	240-415	6	3	35,05
HİRC100-4P-030/80A	80	240-415	10	3	63,75
HİRC100-4P-030/100A	100	240-415	10	3	70,10



4 Kutuplu 300 mA AC tip

Ürün Kodu	Anma Akımı (A)	Çalışma Voltajı (VAC)	Kesme Kapasitesi	Min. Sip. Adedi	Birim Fiyat (\$)
HİRC63-4P-300/25A	25	240-415	6	3	32,31
HİRC63-4P-300/32A	32	240-415	6	3	32,92
HİRC63-4P-300/40A	40	240-415	6	3	33,56
HİRC63-4P-300/63A	63	240-415	6	3	35,05
HİRC100-4P-300/80A	80	240-415	10	3	63,75
HİRC100-4P-300/100A	100	240-415	10	3	70,10

Modüler Kontaktör (AC-1)



Ürün Kodu	Kutup Sayısı	Anma Akımı A (A)	Kontak Sayısı	Kontrol Gerilimi (V AC)	Min. Sip. Adedi	Birim Fiyat (\$)
HIC25 10NS X230	1 Kutup	25A	1NA	230V	1	38,36
HIC25 20NS X230	2 Kutup	25A	2NA	230V	1	38,36
HIC40 20NS X230	2 Kutup	40A	2NA	230V	1	63,17
HIC63 20NS X230	2 Kutup	63A	2NA	230V	1	63,17
HIC25 11NS X230	2 Kutup	25A	1NA+1NK	230V	1	38,36
HIC40 11NS X230	2 Kutup	40A	1NA+1NK	230V	1	63,17
HIC63 11NS X230	2 Kutup	63A	1NA+1NK	230V	1	63,17
HIC25 02NS X230	2 Kutup	25A	2NK	230V	1	38,36
HIC40 02NS X230	2 Kutup	40A	2NK	230V	1	63,17
HIC63 02NS X230	2 Kutup	63A	2NK	230V	1	63,17



HIC25 30NS X230	3 Kutup	25A	3NA	230V	1	53,36
HIC40 30NS X230	3 Kutup	40A	3NA	230V	1	78,94
HIC63 30NS X230	3 Kutup	63A	3NA	230V	1	78,94



HIC25 40NS X230	4 Kutup	25A	4NA	230V	1	53,36
HIC40 40NS X230	4 Kutup	40A	4NA	230V	1	78,94
HIC63 40NS X230	4 Kutup	63A	4NA	230V	1	78,94
HIC25 04NS X230	4 Kutup	25A	4NK	230V	1	53,36
HIC40 04NS X230	4 Kutup	40A	4NK	230V	1	78,94
HIC63 04NS X230	4 Kutup	63A	4NK	230V	1	78,94
HIC25 22NS X230	4 Kutup	25A	2NA+2NK	230V	1	53,36
HIC40 22NS X230	4 Kutup	40A	2NA+2NK	230V	1	78,94
HIC63 22NS X230	4 Kutup	63A	2NA+2NK	230V	1	78,94
HIC25 31NS X230	4 Kutup	25A	3NA+1NK	230V	1	53,36
HIC40 31NS X230	4 Kutup	40A	3NA+1NK	230V	1	78,94
HIC63 31NS X230	4 Kutup	63A	3NA+1NK	230V	1	78,94

GÜÇ KONTAKTÖRLERİ HYUNDAI'NIN YENİ GÜÇLERİ

KONTAKTÖRLER



TERMİK RÖLELER



9A - 800A



3 Kutuplu AC Kontrol Bobinli

Ürün Kodu	Anma Gücü 380-440 VAC (kW)	Anma Akımı AC3 (A)	Anma Akımı AC5 (A)	Termik Akımı AC1 (Ith) (A)	Yardımcı Kontaklar NA NK	Min. Sip. Adedi	Birim Fiyat (\$)
HGC9B10NSX220	4	9	12	25	1 0	24	15,90
HGC12B10NSX220	5,5	12	18	25	1 0	24	17,42
HGC18B10NSX220	7,5	18	25	40	1 0	24	22,42
HGC22B10NSX221	11	22	32	45	1 0	24	31,80
HGC911NSX220	4	9	12	25	1 1	24	22,48
HGC922NSX220	4	9	12	25	2 2	24	28,36
HGC1211NSX220	5,5	12	18	25	1 1	24	24,10
HGC1222NSX220	5,5	12	18	25	2 2	24	30,33
HGC1811NSX220	7,5	18	25	40	1 1	24	29,30
HGC1822NSX220	7,5	18	25	40	2 2	24	35,25
HGC2511NSX220	11	25	32	45	1 1	24	41,85
HGC2522NSX220	11	25	32	45	2 2	24	44,60
HGC3211NSX220	15	32	40	55	1 1	21	44,12
HGC3222NSX220	15	32	40	55	2 2	21	46,02
HGC4011NSX220	18,5	40	50	60	1 1	21	49,01
HGC4022NSX220	18,5	40	50	60	2 2	21	57,54
HGC5022NSX220	22	50	65	70	2 2	14	90,99
HGC6522NSX220	30	65	75	100	2 2	14	108,04
HGC7522NSX220	37	75	85	115	2 2	10	124,66
HGC8522NSX220	45	85	100	125	2 2	10	143,42
HGC10022NSX220	55	100	115	145	2 2	10	157,50
* HGC11522NSY220	60	115	130	160	2 2	6	178,12
* HGC13022NSY220	65	130	150	180	2 2	6	202,42
* HGC15022NSY220	75	150	185	210	2 2	6	234,38
* HGC18522NSY220	90	185	225	275	2 2	3	372,88
* HGC22522NSY220	132	225	265	315	2 2	3	499,50
* HGC26522NSY220	147	265	300	350	2 2	3	565,00
* HGC30022NSY220	160	300	360	400	2 2	2	617,93
* HGC40022NSY220	220	400	450	500	2 2	2	745,76
* HGC50022NSY220	250	500	550	550	2 2	2	865,00
HGC11522NSF220	60	115	130	160	2 2	6	232,50
HGC13022NSF220	65	130	150	180	2 2	6	245,40
HGC15022NSF220	75	150	185	210	2 2	6	284,46
HGC18522NSF220	90	185	225	275	2 2	3	440,56
HGC22522NSF220	132	225	265	315	2 2	3	545,00
HGC26522NSF220	147	265	300	350	2 2	3	640,00
HGC30022NSF220	160	300	360	400	2 2	2	675,00
HGC40022NSF220	220	400	450	500	2 2	2	775,00
HGC50022NSF220	250	500	550	550	2 2	2	905,56
HGC63022NSF220	330	630	700	750	2 2	1	1.512,82
HGC80022NSF220	440	800	850	900	2 2	1	1.856,29

- Bobin voltajı standart 220 VAC'dir. Bobin voltajınız farklı ise lütfen bildiriniz.

- 115A-800A arası kontaktörler ise AC/DC çalışabilmektedir.

* Bu ürünler 220 VAC çalışmaktadır

3 Kutuplu DC Kontrol Bobinli



Ürün Kodu	Anma Gücü 380-440 VAC (kW)	Anma Akımı AC3 (A)	Termik Akımı AC1 (Ith) (A)	Yardımcı Kontaklar		Min. Sip. Adedi	Birim Fiyat (\$)
				NA	NK		
HGC911NSD24	4	9	25	1	1	1	45,52
HGC1211NSD24	5.5	12	25	1	1	1	47,00
HGC1811NSD24	7.5	18	40	1	1	1	56,00
HGC2511NSD24	11	25	45	1	1	1	62,00
HGC3222NSD24	15	32	55	2	2	1	66,00
HGC4022NSD24	18.5	40	60	2	2	1	77,05
HGC5022NSD24	22	50	70	2	2	1	107,00
HGC6522NSD24	30	65	100	2	2	1	126,46
HGC7522NSD24	37	75	115	2	2	1	155,64
HGC8522NSD24	45	85	125	2	2	1	165,36
HGC10022NSD24	55	100	145	2	2	1	184,81

* 100A üzerindeki uygulamalar için Hyundai Elektrik'ten bilgi isteyiniz.

* Bobin değişimi fiyatımızı değiştirmemektedir.

* Bobin voltajı standart 24 VDC dir.farklı bobin voltajı için lütfen bilgi veriniz.

4 Kutuplu AC Kontrol Bobinli



Ürün Kodu	Anma Gücü 380-440 VAC (kW)	Anma Akımı AC3 (A)	Termik Akımı AC1 (Ith) (A)	Yardımcı Kontaklar		Min. Sip. Adedi	Birim Fiyat (\$)
				NA	NK		
H1MC9F	4	9	20	0	0	1	20,86
H1MC12F	5.5	12	20	0	0	1	23,16
H1MC18F	7.5	18	25	0	0	1	27,80
H1MC22F	11	22	32	0	0	1	32,42
H1MC32F	15	32	50	0	0	1	41,69
H1MC40F	18.5	40	50	0	0	1	57,92
H1MC50F	22	50	70	0	0	1	69,48
H1MC65F	30	65	100	2	2	1	104,23
H1MC80F	37	80	110	2	2	1	127,39
H1MC90F	45	90	135	2	2	1	150,55

* Bobin voltajı standart 24 VAC'dir.Bobin voltajınız farklı ise lütfen bildiriniz.

* Bobin değişimi fiyatlarımızı değiştirmemektedir.

Kompanzasyon Kontaktörleri



Ürün Kodu	Kvar AC415 V	Yardımcı Kontaktlar		Min. Sip. Adedi	Birim Fiyat (\$)
		NA	NK		
HGC9C22NSX220	9.7	2	2	10	46,33
HGC12C22NSX220	12	2	2	10	48,17
HGC18C22NSX220	16.7	2	2	10	51,89
HGC25C22NSX220	20	2	2	14	58,37
HGC32C22NSX220	25	2	2	14	76,90
HGC40C22NSX220	29	2	2	14	83,38
HGC50C22NSX220	40	2	2	15	101,92
HGC65C22NSX220	43.5	2	2	15	111,18
HGC75C22NSX220	52	2	2	7	133,41
HGC85C22NSX220	56	2	2	7	151,93
HGC100C22NSX220	62	2	2	7	166,75

* Dirençlerin yanmaması için deşarj süresini en az 60 saniye tutunuz veya deşarj bobini kullanınız.

Kompanzasyon Kontaktör Aksesuarları



Anahtarlama Ünitesi

Ürün Kodu	Birlikte Kullanılacak Kontaktör	Min. Sip. Adedi	Birim Fiyat (\$)
HGCCU4000NS	HGC9-40	6	26,00
HGCCU6500NS	HGC50-65	6	26,80
HGCCU10000NS	HGC75-100	6	27,81

AC Bobinli Yardımcı Kontaktörler (220 VAC)



Ürün Kodu	Anma Akımı AC15 (A) 220V 380V		Termik Akımı AC15 (Ith) (A)	Kontaktlar NA NK		Min. Sip. Adedi	Birim Fiyat (\$)
	10	4		NA	NK		
HGR04NSX220	10	4	20	0	4	1	29,10
HGR13NSX220	10	4	20	1	3	1	29,10
HGR22NSX220	10	4	20	2	2	1	29,10
HGR31NSX220	10	4	20	3	1	1	29,10
HGR40NSX220	10	4	20	4	0	1	29,10

* Bobin voltajı standart 220 VAC'dir. Bobin voltajınız farklı ise lütfen bildiriniz.

* Bobin değişimi fiyatlarımızı değiştirmemektedir.

DC Bobinli Yardımcı Kontaktörler 24 VDC



Ürün Kodu	Anma Akımı AC15 (A) 220V 380V		Termik Akımı AC15 (Ith) (A)	Kontaktlar NA NK		Min. Sip. Adedi	Birim Fiyat (\$)
10	4	NA		NK			
HGR04PSD24	10	4	20	0	4	1	43,77
HGR13PSD24	10	4	20	1	3	1	43,77
HGR22PSD24	10	4	20	2	2	1	43,77
HGR31PSD24	10	4	20	3	1	1	43,77
HGR40PSD24	10	4	20	4	0	1	43,77

* Bobin voltajı standart 24 VAC'dir. Bobin voltajınız farklı ise lütfen bildiriniz.

* Bobin değişimi fiyatlarımızı değiştirmemektedir.

Yardımcı Kontakt Blokları



Ürün Kodu	Birlikte Kullanılan Kontaktör Tipi	Kontaktöre Montaj Şekli	Yardımcı Kontaktlar NA NK	Min. Sip. Adedi	Birim Fiyat (\$)
HGCTB02NS	HGC9-100	Üst	0 2	2	6,49
HGCTB11NS	HGC9-100	Üst	1 1	2	6,49
HGCTB20NS	HGC9-100	Üst	2 0	2	6,49
HGCTB04NS	HGC9-100	Üst	0 4	1	12,05
HGCTB13NS	HGC9-100	Üst	1 3	1	12,05
HGCTB22NS	HGC9-100	Üst	2 2	1	12,05
HGCTB31NS	HGC9-100	Üst	3 1	1	12,05
HGCTB40NS	HGC9-100	Üst	4 0	1	12,05
HGCSB4011NS	HGC9-40	Yandan	1 1	1	6,49
HGCSB10011NS	HGC50-100	Yandan	1 1	1	13,34
HGCSB80011NS	HGC115-800	Yandan	1 1	1	14,83

* Hem üst hem de yan yardımcı kontaktlar birlikte kullanılabilir.

* Üst yardımcı kontak blokları HGR yardımcı kontaktörler için de uygundur.

Elektronik Zamanlama Bloğu



Ürün Kodu	Çalışma Voltajı	Birlikte Kullanılan Kontaktör	Zaman Ayar Sahası (sn.)	Hassasiyet	Min. Sip. Adedi	Birim Fiyat (\$)
HGCE1	AC/DC90-240V	HGC9-100, HGR	0,15-220	% 5	1	64,86
HGC ET2	AC/DC24-60V	HGC9-100, HGR	0,15-220	% 5	1	64,86

AC Yedek Bobinler



Ürün Kodu	Birlikte Kullanılan Kontaktör Tipi	Min. Sip. Adedi	Birim Fiyat (\$)
HGCOLPKG18X220	HGC9-18	5	9,78
HGCOLPKG40X220	HGC25-40	5	9,78
HGCOLPKG65X220	HGC50-65	2	17,61
HGCOLPKG100X220	HGC75-100	2	21,04

DC Yedek Bobinler



Ürün Kodu	Birlikte Kullanılan Kontaktör Tipi	Min. Sip. Adedi	Birim Fiyat (\$)
HGCOLPKG18D24	HGC9-18	5	13,94
HGCOLPKG40D24	HGC25-40	5	15,15
HGCOLPKG65D24	HGC50-65	2	17,37
HGCOLPKG100D24	HGC75-100	2	21,53

Serbest Voltaj Bobinler



Ürün Kodu	Birlikte Kullanılan Kontaktör Tipi	Min. Sip. Adedi	Birim Fiyat (\$)
HGCOL150F220	HGC115-150	2	69,49
HGCOL265F220	HGC185-265	2	123,30
HGCOL400F220	HGC300-500	2	212,97
HGCOL800F220	HGC630-800	2	287,20

Bobin voltajı standart 220 VAC'dir. Bobin voltajınız farklı ise lütfen bildiriniz.



Mekanik Kilitleme Bloğu

Ürün Kodu	Güç Sarfiyatı (W)	Birlikte Kullanılan Kontaktör Tipi	Min. Sip. Adedi	Birim Fiyat (\$)
HGCLB100F220	20	HGC9-100, HGR	2	37,06



Mekanik Kilit (AC/DC)

Ürün Kodu	Birlikte Kullanılan Kontaktör Tipi	Min. Sip. Adedi	Birim Fiyat (\$)
HGCIU40	HGC9-40	1	13,34
HGCIU100	HGC50-100	1	18,52
HGCIU265	HGC115-265	1	21,49
HGCIU400	HGC300-800	1	51,89

* İki kontaktör arasına takılarak kullanılır.



Voltaj Dalgalanma Emici

Ürün Kodu	Birlikte Kullanılan Kontaktör Tipi	Çalışma Voltajı	Min. Sip. Adedi	Birim Fiyat (\$)
HGCRC40Y220	HGC9-40	110-220 AC	1	30,57
HGCRC100Y220	HGC50-100	110-220 AC	1	33,91

Yedek Kontak Takımı



Ürün Kodu	Birlikte Kullanılan Kontaktör Tipi	Min. Sip. Adedi	Birim Fiyat (\$)
HGCTIP9	HGC9	1 Takım	5,75
HGCTIP12	HGC12	1 Takım	7,24
HGCTIP18	HGC18	1 Takım	8,54
HGCTIP25	HGC25	1 Takım	12,05
HGCTIP32	HGC32	1 Takım	13,90
HGCTIP40	HGC40	1 Takım	16,31
HGCTIP50	HGC50	1 Takım	28,50
HGCTIP65	HGC65	1 Takım	42,63
HGCTIP75	HGC75	1 Takım	55,00
HGCTIP85	HGC85	1 Takım	59,00
HGCTIP100	HGC100	1 Takım	64,86
HGCTIP115	HGC115	1 Takım	83,38
HGCTIP130	HGC130	1 Takım	101,92
HGCTIP150	HGC150	1 Takım	120,44
HGCTIP185	HGC185	1 Takım	177,31
HGCTIP225	HGC225	1 Takım	203,81
HGCTIP265	HGC265	1 Takım	250,14
HGCTIP300	HGC300	1 Takım	314,97
HGCTIP400	HGC400	1 Takım	372,05
HGCTIP500	HGC500	1 Takım	463,20
HGCTIP630	HGC630	1 Takım	583,65
HGCTIP800	HGC800	1 Takım	741,13

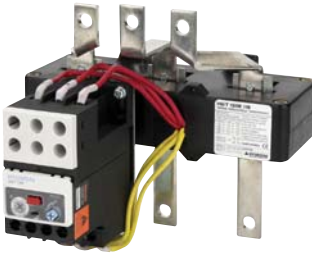

Ürün Kodu	Akım Ayar Sahası (A)	Birlikte Kullanılan Kontaktör Tipi	Akım Trafo Çarpan Oranı	Min. Sip. Adedi	Birim Fiyat (\$)
HGT18KB-0.90S	0.6A - 0.9A	HGC9B-18B	-	28	25,48
HGT18KB-1.20S	0.8A - 1.2A	HGC9B-18B	-	28	25,48
HGT18KB-1.60S	1.1A - 1.6A	HGC9B-18B	-	28	25,48
HGT18KB-2.10S	1.5A - 2.1A	HGC9B-18B	-	28	25,48
HGT18KB-3S	2A - 3A	HGC9B-18B	-	28	25,48
HGT18KB-4.20S	2.8A - 4.2A	HGC9B-18B	-	28	25,48
HGT18KB-5S	3A - 5A	HGC9B-18B	-	28	25,48
HGT18KB-6S	4A - 6A	HGC9B-18B	-	28	25,48
HGT18KB-8S	5.6A - 8A	HGC9B-18B	-	28	25,48
HGT18KB-9S	6A - 9A	HGC9B-18B	-	28	25,48
HGT18KB-12S	8A - 12A	HGC9B-18B	-	28	25,48
HGT18KB-18S	12A - 18A	HGC9B-18B	-	28	25,48
HGT40KB-12S	8A - 12A	HGC25B-40B	-	28	28,08
HGT40KB-18S	12A - 18A	HGC25B-40B	-	28	28,08
HGT40KB-22S	15A - 22A	HGC25B-40B	-	28	28,08
HGT40KB-25S	17A - 25A	HGC25B-40B	-	28	28,08
HGT40KB-32S	22A - 32A	HGC25B-40B	-	28	28,08
HGT40KB-40S	28A - 40A	HGC25B-40B	-	28	28,08
HGT18K-0.90S	0.6A - 0.9A	HGC9-18	-	28	25,48
HGT18K-1.20S	0.8A - 1.2A	HGC9-18	-	28	25,48
HGT18K-1.60S	1.1A - 1.6A	HGC9-18	-	28	25,48
HGT18K-2.10S	1.5A - 2.1A	HGC9-18	-	28	25,48
HGT18K-3S	2A - 3A	HGC9-18	-	28	25,48
HGT18K-4.20S	2.8A - 4.2A	HGC9-18	-	28	25,48
HGT18K-5S	3A - 5A	HGC9-18	-	28	25,48
HGT18K-6S	4A - 6A	HGC9-18	-	28	25,48
HGT18K-8S	5.6A - 8A	HGC9-18	-	28	25,48
HGT18K-9S	6A - 9A	HGC9-18	-	28	25,48
HGT18K-12S	8A - 12A	HGC9-18	-	28	25,48
HGT18K-18S	12A - 18A	HGC9-18	-	28	25,48
HGT40K-12S	8A - 12A	HGC25-40	-	28	28,08
HGT40K-18S	12A - 18A	HGC25-40	-	28	28,08
HGT40K-22S	15A - 22A	HGC25-40	-	28	28,08
HGT40K-25S	17A - 25A	HGC25-40	-	28	28,08
HGT40K-32S	22A - 32A	HGC25-40	-	28	28,08
HGT40K-40S	28A - 40A	HGC25-40	-	28	28,08
HGT65K-25S	17A - 25A	HGC50-65	-	20	36,24
HGT65K-32S	22A - 32A	HGC50-65	-	20	36,24
HGT65K-40S	28A - 40A	HGC50-65	-	20	36,24
HGT65K-50S	34A - 50A	HGC50-65	-	20	36,24
HGT65K-65S	45A - 65A	HGC50-65	-	20	36,24
HGT100K-25S	17A - 25A	HGC75-100	-	15	87,64
HGT100K-32S	22A - 32A	HGC75-100	-	15	87,64
HGT100K-40S	28A - 40A	HGC75-100	-	15	87,64
HGT100K-50S	34A - 50A	HGC75-100	-	15	87,64
HGT100K-65S	45A - 65A	HGC75-100	-	15	87,64
HGT100K-75S	52A - 75A	HGC75-100	-	15	87,64
HGT100K-85S	59A - 85A	HGC75-100	-	15	87,64
HGT100K-100S	70A - 100A	HGC75-100	-	15	87,64
HGT150K-80S	48A - 80A	HGC115-150	80/5	3	132,55
HGT150K-115S	69A - 115A	HGC115-150	115/5	3	132,55
HGT150K-130S	78A - 130A	HGC115-150	130/5	3	132,55
HGT150K-150S	90A - 150A	HGC115-150	150/5	3	132,55
HGT265K-115S	69A - 115A	HGC185-265	115/5	3	214,01
HGT265K-130S	78A - 130A	HGC185-265	130/5	3	214,01
HGT265K-150S	90A - 150A	HGC185-265	150/5	3	214,01
HGT265K-185S	111A - 185A	HGC185-265	185/5	3	214,01
HGT265K-225S	135A - 225A	HGC185-265	225/5	3	234,38
HGT265K-265S	159A - 265A	HGC185-265	265/5	3	234,38
HGT500K-265S	159A - 265A	HGC300-500	265/5	3	254,77
HGT500K-300S	180A - 300A	HGC300-500	300/5	3	254,77
HGT500K-400S	240A - 400A	HGC300-500	400/5	3	254,77
HGT500K-500S	300A - 500A	HGC300-500	500/5	3	254,77
HGT800K-630S	378A - 630A	HGC630-800	630/5	1	499,50
HGT800K-800S	480A - 800A	HGC630-800	800/5	1	499,50

Termik Ray Montaj Modülü

Ürün Kodu	Birlikte Kullanılan Termik	Min. Sip. Adedi	Birim Fiyat (\$)
HGTMB18	HGT18	2	7,41
HGTMB40	HGT40	2	8,34
HGTMB65	HGT65	2	9,27
HGTMB100	HGT100	2	13,25

* Termiklere hem ray hem de vida montaj imkanı sağlar.

* Fiyat listesi ürünler stokludur.

* Liste harici ürünler için lütfen stok sorunuz.



Ürün Kodu	Nominal Akım (A)	Termik Ayar Sahası (A)	Min. Sip. Adedi	Birim Fiyat (\$)
HMMS-32K/0.16S	0.16	0,1-0,16	1	33,20
HMMS-32K/0.25S	0.25	0,16-0,25	1	33,20
HMMS-32K/0.40S	0.4	0,25-0,4	1	33,20
HMMS-32K/0.63S	0.63	0,40-0,63	1	33,20
HMMS-32K/1S	1	0,63-1	1	33,20
HMMS-32K/1.6S	1.6	1-1,6	1	33,67
HMMS-32K/2.5S	2.5	1,16-2,5	1	33,67
HMMS-32K/4S	4	2,5-4	1	34,88
HMMS-32K/6S	6.3	4-6,3	1	34,88
HMMS-32K/10S	10	6-10	1	35,41
HMMS-32K/14S	14	9-14	1	36,10
HMMS-32K/18S	18	13-18	1	36,33
HMMS-32K/23S	23	17-23	1	37,50
HMMS-32K/25S	25	20-25	1	37,50
HMMS-32K/32S	32	24-32	1	37,50
HMMS-80K/40S	40	25-40	1	104,14
HMMS-80K/63S	63	40-63	1	113,39
HMMS-80K/80S	80	56-80	1	138,85

* Kesme kapasitesi 10-100 kA arasındadır.

* Düşük gerilim bobini, açtırma bobini, yardımcı kontak gibi aksesuarlar motor koruma şalterlerine eklenebilir.

* Aşırı yük, faz kaybı, kısa devre gibi motorda oluşacak istenmeyen durumlarda hassas koruma sağlar.

* Aynı zamanda dağıtım hatlarında koruma için de kullanılabilir.



Motor Koruma Şalterleri - Döner Kurma Kollu (10-100kA)

HMMS32R0P16	0.16	0.1-0.16A	1	49,80
HMMS32R0P25	0.25	0.16-0.25A	1	49,80
HMMS32R0P40	0.4	0.25-0.4A	1	49,80
HMMS32R0P63	0.63	0.4-0.63A	1	49,80
HMMS32R1P00	1	0.63-1A	1	49,80
HMMS32R01P6	1.6	1-1.6A	1	50,50
HMMS32R02P5	2.5	1.6-2.5A	1	50,50
HMMS32R0004	4	2.5-4A	1	53,10
HMMS32R06P3	6.3	4-6.3A	1	53,10
HMMS32R0010	10	6-10A	1	53,10
HMMS32R0014	14	9-14A	1	53,10
HMMS32R0018	18	13-18A	1	54,10
HMMS32R0023	23	17-23A	1	55,10
HMMS32R0025	25	20-25A	1	55,10
HMMS32R0032	32	24-32A	1	55,10

Motor Koruma Şalter Aksesuarları



Ürün Kodu	Açıklama	Min. Sip. Adedi	Birim Fiyat (\$)
HMMS-32K-AUX-T11	Üst Yardımcı Kontak (1NA/1NK)	1	6,61
HMMS-32K-AUX-S11	Yan Yardımcı Kontak	1	11,02
HMMS-32K-AUX-S20	Yan Yardımcı Kontak (1NA/1NK)	1	11,02
HMMS-32K-AXT-1010	Yan 1NA Yardımcı / 1 NK Alarm kontak	1	16,04
HMMS-32K-AXT-1001	Yan 1NA Yardımcı / 1 NA Alarm kontak	1	16,04
HMMS-32K-AXT-0110	Yan 1NK Yardımcı / 1 NK Alarm kontak	1	16,04
HMMS-32K-AXT-0101	Yan 1NK Yardımcı / 1 NA Alarm kontak	1	16,04
HMMS-32K-UVT-240	Yan düşük Gerilim Bobini (220VAC)	1	28,06
HMMS-32K-SHT-240	Yan Açtırma Bobini (220VAC)	1	28,06
HMMS-80K-AUX-S11	Yan Yardımcı Kontak (1NA/1NK)	1	22,06
HMMS-80 K- AUX-S20	Yan Yardımcı Kontak (2NA)	1	22,06
HMMS-80K-ALT-10	Yan 1NA alarm Kontak	1	22,06
HMMS-80K-ALT-01	Yan 1NK alarm Kontak	1	22,06
MMS32KENC	Kutu (IP55)	1	16,04
TFHMMS32R	Kurma Kollu Kolu (MMS32R için)	1	38,09

UCB/HGM/HGE SERİSİ KOMPAKT ŞALTERLER



HGM Serisi
Kompakt Şalterler (16-800A)



HGP Serisi
Kompakt Şalterler (16-800A)



UCB Serisi
Kompakt Şalterler (16-1600A)



HGE Serisi
Kaçak Akım Korumalı Şalterler (16-400A)



Termik Sabit, Manyetik Sabit (3 Kutup)

Sabit

Ürün Kodu	Anma Akımı (A)	Manyetik Ayar Sahası	Kesme Şekli	Kesme Kap. 380 VAC Icu (KA)	Min. Sip. Adedi	Birim Fiyat (\$)
UCB100R3P16	16	10xIn (Sabit)	T/M	30kA	14	77,81
UCB100R3P20	20	10xIn (Sabit)	T/M	30kA	14	77,81
UCB100R3P25	25	10xIn (Sabit)	T/M	30kA	14	77,81
UCB100R3P32	32	10xIn (Sabit)	T/M	30kA	14	77,81
UCB100R3P40	40	10xIn (Sabit)	T/M	30kA	14	77,81
UCB100R3P50	50	10xIn (Sabit)	T/M	30kA	14	77,81
UCB100R3P63	63	10xIn (Sabit)	T/M	30kA	14	77,81
UCB100R3P80	80	10xIn (Sabit)	T/M	30kA	14	83,66
UCB100R3P100	100	10xIn (Sabit)	T/M	30kA	14	83,66
UCB100R3P125	125	10xIn (Sabit)	T/M	30kA	14	103,10
UCB250S3P160	160	10xIn (Sabit)	T/M	35kA	12	134,23
UCB250S3P200	200	10xIn (Sabit)	T/M	35kA	12	142,03
UCB250S3P250	250	10xIn (Sabit)	T/M	35kA	12	159,52
UCB400S3P300	300	10xIn (Sabit)	T/M	42kA	3	250,97
UCB400S3P400	400	10xIn (Sabit)	T/M	42kA	3	262,64
UCB630S3P500	500	10xIn (Sabit)	T/M	65kA	2	398,82
UCB630S3P630	630	10xIn (Sabit)	T/M	65kA	2	408,54
UCB800S3P800	800	10xIn (Sabit)	T/M	65kA	2	486,37



Termik Sabit, Manyetik Sabit (4 Kutup)

Sabit

Ürün Kodu	Anma Akımı (A)	Manyetik Ayar Sahası	Kesme Şekli	Kesme Kap. 380 VAC Icu (KA)	Min. Sip. Adedi	Birim Fiyat (\$)
UCB100R4P16	16	10xIn (Sabit)	T/M	30kA	12	103,76
UCB100R4P20	20	10xIn (Sabit)	T/M	30kA	12	103,76
UCB100R4P25	25	10xIn (Sabit)	T/M	30kA	12	103,76
UCB100R4P32	32	10xIn (Sabit)	T/M	30kA	12	103,76
UCB100R4P40	40	10xIn (Sabit)	T/M	30kA	12	103,76
UCB100R4P50	50	10xIn (Sabit)	T/M	30kA	12	103,76
UCB100R4P63	63	10xIn (Sabit)	T/M	30kA	12	103,76
UCB100R4P80	80	10xIn (Sabit)	T/M	30kA	12	111,55
UCB100R4P100	100	10xIn (Sabit)	T/M	30kA	12	111,55
UCB100R4P125	125	10xIn (Sabit)	T/M	30kA	12	137,49
UCB250S4P160	160	10xIn (Sabit)	T/M	35kA	6	178,99
UCB250S4P200	200	10xIn (Sabit)	T/M	35kA	6	189,37
UCB250S4P250	250	10xIn (Sabit)	T/M	35kA	6	212,71
UCB400S4P300	300	10xIn (Sabit)	T/M	42kA	2	334,63
UCB400S4P400	400	10xIn (Sabit)	T/M	42kA	2	350,19
UCB630S4P500	500	10xIn (Sabit)	T/M	65kA	1	531,77
UCB630S4P630	630	10xIn (Sabit)	T/M	65kA	1	544,73
UCB800S4P800	800	10xIn (Sabit)	T/M	65kA	1	648,48



Termik Ayarlı, Manyetik Sabit (3 Kutup)

Ayarlı

Ürün Kodu	Anma Akımı (A)	Termik Ayar Sahası (A)	Manyetik Ayar Sahası	Kesme Şekli	Kesme Kap. 380 VAC Icu (KA)	Min. Sip. Adedi	Birim Fiyat (\$)
UCB100R3P16F	16	12-16	10xIn(Sabit)	T/M	30kA	14	87,55
UCB100R3P20F	20	16-20	10xIn(Sabit)	T/M	30kA	14	87,55
UCB100R3P25F	25	20-25	10xIn(Sabit)	T/M	30kA	14	87,55
UCB100R3P32F	32	20-32	10xIn(Sabit)	T/M	30kA	14	87,55
UCB100R3P40F	40	32-40	10xIn(Sabit)	T/M	30kA	14	87,55
UCB100R3P50F	50	50-40	10xIn(Sabit)	T/M	30kA	14	87,55
UCB100R3P63F	63	50-63	10xIn(Sabit)	T/M	30kA	14	87,55
UCB100R3P80F	80	64-80	10xIn(Sabit)	T/M	30kA	14	95,34
UCB100R3P100F	100	80-100	10xIn(Sabit)	T/M	30kA	14	95,34
UCB100R3P125F	125	100-125	10xIn(Sabit)	T/M	30kA	14	116,74
UCB250S3P160F	160	128-160	10xIn(Sabit)	T/M	35kA	12	145,92
UCB250S3P200F	200	160-200	10xIn(Sabit)	T/M	35kA	12	155,64
UCB250S3P250F	250	200-250	10xIn(Sabit)	T/M	35kA	12	175,09
UCB400S3P300F	300	240-300	10xIn(Sabit)	T/M	42kA	3	272,37
UCB400S3P400F	400	320-400	10xIn(Sabit)	T/M	42kA	3	291,83
UCB630S3P500F	500	400-500	10xIn(Sabit)	T/M	65kA	2	428,01
UCB630S3P630F	630	500-630	10xIn(Sabit)	T/M	65kA	2	466,92
UCB800S3P800F	800	640-800	10xIn(Sabit)	T/M	65kA	2	544,73
UCB1000S3P1000F	1000	505-1000	(2-10)In	E	100kA	1	1.945,45
UCB1250S3P1250F	1250	650-1250	(2-10)In	E	100kA	1	2.130,73
UCB1600S3P1600F	1600	640-1600	(2-10)In	E	65kA	1	3.149,78

Termik Ayarlı, Manyetik Sabit (4 Kutup)

Ayarlı

Ürün Kodu	Anma Akımı (A)	Termik Ayar Sahası (A)	Manyetik Ayar Sahası	Kesme Şekli	Kesme Kap. 380 VAC Icu (KA)	Min. Sip. Adedi	Birim Fiyat (\$)
UCB100R4P16F	16	12-16	10xIn(Sabit)	T/M	30kA	12	116,74
UCB100R4P20F	20	16-20	10xIn(Sabit)	T/M	30kA	12	116,74
UCB100R4P25F	25	20-25	10xIn(Sabit)	T/M	30kA	12	116,74
UCB100R4P32F	32	20-32	10xIn(Sabit)	T/M	30kA	12	116,74
UCB100R4P40F	40	32-40	10xIn(Sabit)	T/M	30kA	12	116,74
UCB100R4P50F	50	50-40	10xIn(Sabit)	T/M	30kA	12	116,74
UCB100R4P63F	63	50-63	10xIn(Sabit)	T/M	30kA	12	116,74
UCB100R4P80F	80	64-80	10xIn(Sabit)	T/M	30kA	12	127,12
UCB100R4P100F	100	80-100	10xIn(Sabit)	T/M	30kA	12	127,12
UCB100R4P125F	125	100-125	10xIn(Sabit)	T/M	30kA	12	155,64
UCB250S4P160F	160	128-160	10xIn(Sabit)	T/M	35kA	10	194,56
UCB250S4P200F	200	160-200	10xIn(Sabit)	T/M	35kA	10	207,52
UCB250S4P250F	250	200-250	10xIn(Sabit)	T/M	35kA	10	233,45
UCB400S4P300F	300	240-300	10xIn(Sabit)	T/M	42kA	2	363,15
UCB400S4P400F	400	320-400	10xIn(Sabit)	T/M	42kA	2	389,09
UCB630S4P500F	500	400-500	10xIn(Sabit)	T/M	65kA	2	570,67
UCB630S4P630F	630	500-630	10xIn(Sabit)	T/M	65kA	2	622,55
UCB800S4P800F	800	640-800	10xIn(Sabit)	T/M	65kA	2	726,31
UCB1000S4P1000F	1000	505-1000	(2-10)In	E	100kA	1	2.488,07
UCB1250S4P1250F	1250	650-1250	(2-10)In	E	100kA	1	2.725,15



Ürün Kodu	Açıklama	Birim Fiyat (\$)
Yardımcı Kontak Bloğu		
AUX 10B L1	UCB100S için sol montajlı yardımcı kontak bloğu	18,52
AUX 20C L1	UCB250S için sol montajlı yardımcı kontak bloğu	18,52
AUX 46D R1	UCB400-630-800R/S/H, için sağ montajlı yardımcı kontak bloğu	39,84
AUX 80NE R1	UCB1000-1250S/L, için sağ montajlı yardımcı kontak bloğu	58,37
AUX 160NE R1	UCB1600S için yardımcı kontak bloğu	114,87
Alarm Kontakı		
ALT 10C L1	UCB100S için sol montajlı alarm kontakı	18,52
ALT 20C L1	UCB250S için sol montajlı alarm kontakı	18,52
ALT 46D L1	UCB400-630-800R/S/H, için sol montajlı alarm kontakı	39,84
ALT 80NE R1	UCB1000-1250S/L, için sol montajlı alarm kontakı	58,37
ALT 160NE R1	UCB1600S için sol montajlı alarm kontakı	114,87
Açtırma Bobini		
SHT 10B	UCB100S için açtırma bobini - 230 V AC	40,77
SHT 20C	UCB250S için açtırma bobini	40,77
SHT 46D	UCB400-630-800R/S/H, için açtırma bobini - 230 V AC	81,53
SHT 120NE	UCB1000-1250S/L, için açtırma bobini - 230 V AC	113,03
SHT 160NE	UCB1600S için açtırma bobini - 230 V AC	166,75
Düşük Gerilim Bobini		
UVT 10B	UCB100S için düşük gerilim bobini - 230 V AC	53,74
UVT 20C	UCB250S için düşük gerilim bobini	53,74
UVT 46D	UCB400-630-800R/S/H, için düşük gerilim bobini - 230 V AC	85,23
UVT 120NE	UCB1000-1250S/L, için düşük gerilim bobini - 230 V AC	120,44
UVT 160NE	UCB1600S için düşük gerilim bobini - 230 V AC	185,28
Kurma Kolu		
TFG 10BS U4	UCB100S için kurma kolu	48,17
TFG 20CS U4	UCB250S için kurma kolu	50,95
TFG 46DS U2	UCB400-630-800R/S/H, için kurma kolu	75,98
Uzatmalı Tip Kurma Kolu		
TFH 10BS	UCB100S için uzatmalı kurma kolu	53,74
TFH 20CS	UCB250S için uzatmalı kurma kolu	50,95
TFH 46DS	UCB400-630-800R/S/H, için uzatmalı kurma kolu	75,98



Ürün Kodu	Açıklama	Birim Fiyat (\$)
-----------	----------	------------------

Motor Mekanizması

MOT 10B	UCB100S için motor mekanizması	444,68
MOT 20C	UCB250S için motor mekanizması	463,20
MOT 40D	UCB400R/S/H/L kasası için motor mekanizması	509,53
MOT 68E	UCB630-800R/S/H/L için motor mekanizması	592,90
MOT 80NE	UCB1000-1250S/L için motor mekanizması	648,48
MOT 160NE	UCB1600S için motor mekanizması	1.019,05

Mekanik Kilitleme

MIF 10UF 3	UCB100S 3 kutuplu için mekanik kilit	92,64
MIF 20UG 3	UCB250S 3 kutuplu için mekanik kilit	103,76
MIF 40D 3	UCB400R/S/H/L 3 kutuplu için mekanik kilit	106,55
MIF 80E 3	UCB630-800R/S/H/L 3 kutuplu için mekanik kilit	112,09
MIF 10UA 4	UCB100S 4 kutuplu için mekanik kilit	100,98
MIF 20UG 4	UCB250S 4 kutuplu için mekanik kilit	103,76
MIF 40D 4	UCB400R/S/H/L 4 kutup için mekanik kilit	109,33
MIF 80E 4	UCB630-800R/S/H/L 4 kutuplu için mekanik kilit	117,66



Kurma Kol Kilidi

PLD 10UF	UCB100S için kurma kolu kilidi	33,35
PLD 20UG	UCB250S için kurma kolu kilidi	44,47
PLD 40D	UCB400-630-800R/S/H/L için kurma kolu	66,89
PLD 120E	UCB1000-1250S/L için kurma kolu kilidi	83,93

Montaj Barası

TBB 20C 3	UCB250S 3 kutup için montaj barası	31,13
TBB 4S 3	UCB400R/S/H/L 3 kutup için montaj barası	56,88
TBB 6S 3	UCB800R/S/H/L 3 kutup için montaj barası	62,63
TBB 8S 3	UCB630R/S/H/L 3 kutup için montaj barası	83,93
TBB 20C 4	UCB250S 4 kutup için montaj barası	33,53
TBB 4S 4	UCB400R/S/H/L 4 kutup için montaj barası	60,41
TBB 6S 4	UCB800R/S/H/L 4 kutup için montaj barası	66,89
TBB 8S 4	UCB630R/S/H/L 4 kutup için montaj barası	91,91



ICS= ICU%100



Termik Sabit, Manyetik Sabit (3 Kutup)

Sabit

Ürün Kodu	Anma Akımı (A)	Manyetik Ayar Sahası	Kesme Şekli	Kesme Kap. 380 VAC Icu (KA)	Min. Sip. Adedi	Birim Fiyat (\$)
HGM125S-3P16	16	10xIn(Sabit)	T/M	26kA	10	91,53
HGM125S-3P20	20	10xIn(Sabit)	T/M	26kA	10	91,53
HGM125S-3P25	25	10xIn(Sabit)	T/M	26kA	10	91,53
HGM125S-3P32	32	10xIn(Sabit)	T/M	26kA	10	91,53
HGM125S-3P40	40	10xIn(Sabit)	T/M	26kA	10	91,53
HGM125S-3P50	50	10xIn(Sabit)	T/M	26kA	10	91,53
HGM125S-3P63	63	10xIn(Sabit)	T/M	26kA	10	91,53
HGM125S-3P80	80	10xIn(Sabit)	T/M	26kA	10	95,34
HGM125S-3P100	100	10xIn(Sabit)	T/M	26kA	10	95,34
HGM125S-3P125	125	10xIn(Sabit)	T/M	26kA	10	116,74
HGM250S-3P160	160	10xIn(Sabit)	T/M	26kA	9	130,35
HGM250S-3P200	200	10xIn(Sabit)	T/M	26kA	9	155,64
HGM250S-3P250	250	10xIn(Sabit)	T/M	26kA	9	175,09
HGM400S-3P300	300	10xIn(Sabit)	T/M	65kA	3	311,28
HGM400S-3P400	400	10xIn(Sabit)	T/M	65kA	3	335,60
HGM630S-3P500	500	10xIn(Sabit)	T/M	65kA	1	513,61
HGM630S-3P630	630	10xIn(Sabit)	T/M	65kA	1	536,95
HGM800S-3P800	800	10xIn(Sabit)	T/M	65kA	1	544,73

Termik Sabit, Manyetik Sabit (4 Kutup)

Sabit

Ürün Kodu	Anma Akımı (A)	Manyetik Ayar Sahası	Kesme Şekli	Kesme Kap. 380 VAC Icu (KA)	Min. Sip. Adedi	Birim Fiyat (\$)
HGM125S-4P16	16	10xIn(Sabit)	T/M	26kA	8	116,74
HGM125S-4P20	20	10xIn(Sabit)	T/M	26kA	8	116,74
HGM125S-4P25	25	10xIn(Sabit)	T/M	26kA	8	116,74
HGM125S-4P32	32	10xIn(Sabit)	T/M	26kA	8	116,74
HGM125S-4P40	40	10xIn(Sabit)	T/M	26kA	8	116,74
HGM125S-4P50	50	10xIn(Sabit)	T/M	26kA	8	116,74
HGM125S-4P63	63	10xIn(Sabit)	T/M	26kA	8	116,74
HGM125S-4P80	80	10xIn(Sabit)	T/M	26kA	8	127,12
HGM125S-4P100	100	10xIn(Sabit)	T/M	26kA	8	127,12
HGM125S-4P125	125	10xIn(Sabit)	T/M	26kA	8	155,64
HGM250S-4P160	160	10xIn(Sabit)	T/M	26kA	6	173,80
HGM250S-4P200	200	10xIn(Sabit)	T/M	26kA	6	207,52
HGM250S-4P250	250	10xIn(Sabit)	T/M	26kA	6	233,45
HGM400S-4P300	300	10xIn(Sabit)	T/M	65kA	3	397,74
HGM400S-4P400	400	10xIn(Sabit)	T/M	65kA	3	428,00
HGM630S-4P500	500	10xIn(Sabit)	T/M	65kA	1	656,27
HGM630S-4P630	630	10xIn(Sabit)	T/M	65kA	1	684,80
HGM800S-4P800	800	10xIn(Sabit)	T/M	65kA	1	726,31



HGM Serisi Kompakt Şalterler (3 Kutuplu)

ICS= ICU%100



Termik Ayarlı, Manyetik Sabit (3 Kutuplu)

Ayarlı

Ürün Kodu	Anma Akımı (A)	Termik Ayar Sahası	Manyetik Ayar Sahası	Kesme Şekli	Kesme Kap. 380 VAC Icu (KA)	Min. Sip. Adedi	Birim Fiyat (\$)
HGM125S-3P16F	16	12-16	10xIn(Sabit)	T/M	26	10	104,14
HGM125S-3P20F	20	16-20	10xIn(Sabit)	T/M	26	10	104,14
HGM125S-3P25F	25	20-25	10xIn(Sabit)	T/M	26	10	104,14
HGM125S-3P32F	32	20-32	10xIn(Sabit)	T/M	26	10	104,14
HGM125S-3P40F	40	32-40	10xIn(Sabit)	T/M	26	10	104,14
HGM125S-3P50F	50	40-50	10xIn(Sabit)	T/M	26	10	104,14
HGM125S-3P63F	63	50-63	10xIn(Sabit)	T/M	26	10	104,14
HGM125S-3P80F	80	64-80	10xIn(Sabit)	T/M	26	10	113,39
HGM125S-3P100F	100	80-100	10xIn(Sabit)	T/M	26	10	113,39
HGM125S-3P125F	125	100-125	10xIn(Sabit)	T/M	26	10	138,97
HGM250S-3P160F	160	128-160	10xIn(Sabit)	T/M	26	9	155,08
HGM250S-3P200F	200	160-200	10xIn(Sabit)	T/M	26	9	185,28
HGM250S-3P250F	250	200-250	10xIn(Sabit)	T/M	26	9	208,44
HGM125H-3P16F	16	12-16	10xIn(Sabit)	T/M	38	10	109,34
HGM125H-3P20F	20	16-20	10xIn(Sabit)	T/M	38	10	109,34
HGM125H-3P25F	25	20-25	10xIn(Sabit)	T/M	38	10	109,34
HGM125H-3P32F	32	20-32	10xIn(Sabit)	T/M	38	10	109,34
HGM125H-3P40F	40	32-40	10xIn(Sabit)	T/M	38	10	109,34
HGM125H-3P50F	50	40-50	10xIn(Sabit)	T/M	38	10	109,34
HGM125H-3P63F	63	50-63	10xIn(Sabit)	T/M	38	10	109,34
HGM125H-3P80F	80	64-80	10xIn(Sabit)	T/M	38	10	119,06
HGM125H-3P100F	100	80-100	10xIn(Sabit)	T/M	38	10	119,06
HGM125H-3P125F	125	100-125	10xIn(Sabit)	T/M	38	10	145,92
HGM250H-3P160F	160	128-160	10xIn(Sabit)	T/M	38	9	162,84
HGM250H-3P200F	200	160-200	10xIn(Sabit)	T/M	38	9	194,56
HGM250H-3P250F	250	200-250	10xIn(Sabit)	T/M	38	9	218,87
HGM400E-3P300F	300	240-300	10xIn(Sabit)	T/M	38	3	331,54
HGM400E-3P400F	400	320-400	10xIn(Sabit)	T/M	38	3	353,91
HGM630E-3P500F	500	400-500	10xIn(Sabit)	T/M	38	1	501,67
HGM630E-3P630F	630	500-630	10xIn(Sabit)	T/M	38	1	535,68
HGM125L-3P80F	80	64-80	10xIn(Sabit)	T/M	55	10	125,00
HGM125L-3P100F	100	80-100	10xIn(Sabit)	T/M	55	10	125,00
HGM250L-3P125F	125	100-125	10xIn(Sabit)	T/M	55	10	153,22
HGM250L-3P160F	160	128-160	10xIn(Sabit)	T/M	55	9	170,97
HGM250L-3P200F	200	160-200	10xIn(Sabit)	T/M	55	9	204,28
HGM250L-3P250F	250	200-250	10xIn(Sabit)	T/M	55	9	229,81
HGM400S-3P300F	300	240-300	10xIn(Sabit)	T/M	65	3	289,42
HGM400S-3P400F	400	320-400	10xIn(Sabit)	T/M	65	3	347,40
HGM630S-3P500F	500	400-500	10xIn(Sabit)	T/M	65	1	509,53
HGM630S-3P630F	630	500-630	10xIn(Sabit)	T/M	65	1	555,85
HGM800S-3P800F	800	640-800	10xIn(Sabit)	T/M	65	1	648,48
HGM1000S-3PENS1000	1000	500-1000	(2-10)In	E	100	1	1.945,45
HGM1250S-3PENS1250	1250	650-1250	(2-10)In	E	100	1	2.130,73
HGM1600S-3PENS1600	1600	640-1600	(2-10)In	E	65	1	3.149,78

HGM Serisi Kompakt Şalterler (4 Kutuplu)

ICS= ICU%100



Termik Ayarlı, Manyetik Sabit (4 Kutuplu)

Ayarlı

Ürün Kodu	Anma Akımı (A)	Termik Ayar Sahası	Manyetik Ayar Sahası	Kesme Şekli	Kesme Kap. 380 VAC Icu (KA)	Min. Sip. Adedi	Birim Fiyat (\$)
HGM125S-4P16F	16	12-16	10xIn(Sabit)	T/M	26	10	133,17
HGM125S-4P20F	20	16-20	10xIn(Sabit)	T/M	26	10	133,17
HGM125S-4P25F	25	20-25	10xIn(Sabit)	T/M	26	10	133,17
HGM125S-4P32F	32	20-32	10xIn(Sabit)	T/M	26	10	133,17
HGM125S-4P40F	40	32-40	10xIn(Sabit)	T/M	26	10	133,17
HGM125S-4P50F	50	40-50	10xIn(Sabit)	T/M	26	10	133,17
HGM125S-4P63F	63	50-63	10xIn(Sabit)	T/M	26	10	133,17
HGM125S-4P80F	80	64-80	10xIn(Sabit)	T/M	26	10	145,02
HGM125S-4P100F	100	80-100	10xIn(Sabit)	T/M	26	10	145,02
HGM125S-4P125F	125	100-125	10xIn(Sabit)	T/M	26	10	177,73
HGM250S-4P160F	160	128-160	10xIn(Sabit)	T/M	26	9	198,33
HGM250S-4P200F	200	160-200	10xIn(Sabit)	T/M	26	9	236,95
HGM250S-4P250F	250	200-250	10xIn(Sabit)	T/M	26	9	266,57
HGM125H-4P16F	16	12-16	10xIn(Sabit)	T/M	38	10	139,83
HGM125H-4P20F	20	16-20	10xIn(Sabit)	T/M	38	10	139,83
HGM125H-4P25F	25	20-25	10xIn(Sabit)	T/M	38	10	139,83
HGM125H-4P32F	32	20-32	10xIn(Sabit)	T/M	38	10	139,83
HGM125H-4P40F	40	32-40	10xIn(Sabit)	T/M	38	10	139,83
HGM125H-4P50F	50	40-50	10xIn(Sabit)	T/M	38	10	139,83
HGM125H-4P63F	63	50-63	10xIn(Sabit)	T/M	38	10	139,83
HGM125H-4P80F	80	64-80	10xIn(Sabit)	T/M	38	10	152,26
HGM125H-4P100F	100	80-100	10xIn(Sabit)	T/M	38	10	152,26
HGM125H-4P125F	125	100-125	10xIn(Sabit)	T/M	38	10	186,62
HGM250H-4P160F	160	128-160	10xIn(Sabit)	T/M	38	9	208,25
HGM250H-4P200F	200	160-200	10xIn(Sabit)	T/M	38	9	248,81
HGM250H-4P250F	250	200-250	10xIn(Sabit)	T/M	38	9	279,91
HGM400E-4P300F	300	240-300	10xIn(Sabit)	T/M	38	3	424,04
HGM400E-4P400F	400	320-400	10xIn(Sabit)	T/M	38	3	452,64
HGM630E-4P500F	500	400-500	10xIn(Sabit)	T/M	38	1	641,59
HGM630E-4P630F	630	500-630	10xIn(Sabit)	T/M	38	1	685,07
HGM125L-4P80F	80	64-80	10xIn(Sabit)	T/M	55	10	159,87
HGM125L-4P100F	100	80-100	10xIn(Sabit)	T/M	55	10	159,87
HGM250L-4P125F	125	100-125	10xIn(Sabit)	T/M	55	10	195,93
HGM250L-4P160F	160	128-160	10xIn(Sabit)	T/M	55	9	218,66
HGM250L-4P200F	200	160-200	10xIn(Sabit)	T/M	55	9	261,25
HGM250L-4P250F	250	200-250	10xIn(Sabit)	T/M	55	9	293,91
HGM400S-4P300F	300	240-300	10xIn(Sabit)	T/M	65	3	370,14
HGM400S-4P400F	400	320-400	10xIn(Sabit)	T/M	65	3	444,30
HGM630S-4P500F	500	400-500	10xIn(Sabit)	T/M	65	1	651,65
HGM630S-4P630F	630	500-630	10xIn(Sabit)	T/M	65	1	710,88
HGM800S-4P800F	800	640-800	10xIn(Sabit)	T/M	65	1	829,37
HGM1000S-4PENS1000	1000	500-1000	(2-10)In	E	100	1	2.488,07
HGM1250S-4PENS1250	1250	650-1250	(2-10)In	E	100	1	2.725,15

Ürün Kodu	Açıklama	Birim Fiyat (\$)
Yardımcı Kontak Bloğu		
AUX 10GM C1	HGM/HGE 125-250 kasası için yardımcı kontak bloğu	17,79
AUX 10GM C2	HGM/HGE 125-250 kasası için yardımcı kontak bloğu	19,46
AUX 40GM C1	HGM/HGE 400 kasası için yardımcı kontak bloğu	23,16
AUX 80GM	HGM/HGE 800 kasası için yardımcı kontak bloğu	27,81
Alarm Konağı		
ALT 10GM L1	HGM/HGE 125-250 kasası için yardımcı kontak bloğu	17,79
ALT 20GM L1	HGM/HGE 125-250 kasası için yardımcı kontak bloğu	19,46
ALT 40GM L1	HGM/HGE 400 kasası için alarm konağı	23,16
ALT 80GM	HGM/HGE 800 kasası için alarm konağı	27,81
Açtırma Bobini		
SHT 10GM	HGM/HGE 125-250 kasası için açtırma bobini - 230 V AC	40,21
SHT 20GM	HGM/HGE 125-250 kasası için açtırma bobini - 230 V AC	41,69
SHT 40GM	HGM/HGE 400 kasası için açtırma bobini 230 V AC	46,33
SHT 80GM	HGM/HGE 800 kasası için açtırma bobini 230 V AC	46,33
Düşük Gerilim Bobini		
UVT 10GM	HGM/HGE 125-250 kasası için düşük gerilim bobini 230 V AC	74,12
UVT 20GM	HGM/HGE 125-250 kasası için düşük gerilim bobini 230 V AC	83,38
UVT 40GM	HGM/HGE 400 kasası için düşük gerilim bobini 230 V AC	112,09
UVT 80GM	HGM/HGE 800 kasası için düşük gerilim bobini 230 V AC	116,74
Kurma Kolu		
TFG 12GM U	HGM/HGE 125 kasası için kurma kolu	46,33
TFG 25GM U	HGM/HGE 250 kasası için kurma kolu	50,04
TFG 40GM U	HGM/HGE 400 kasası için kurma kolu	78,75
TFG 80GM U	HGM/HGE 800 kasası için kurma kolu	83,38
Uzatmalı Tip Kurma Kolu		
TFH 12GM U	HGM/HGE 125 kasası için uzatmalı kurma kolu	48,17
TFH 25GM U	HGM/HGE 250 kasası için uzatmalı kurma kolu	51,89
TFH 40GM U	HGM/HGE 400 kasası için uzatmalı kurma kolu	94,50
TFH 80GM U	HGM/HGE 800 kasası için uzatmalı kurma kolu	98,21
Mekanik Kilit		
MIF10GM3	HGM/HGE 100 3P için mekanik kilit	24,09
MIF10GMR4	HGM/HGE 100 4P için mekanik kilit	24,09
MIF12GM3	HGM/HGE 125 3P için mekanik kilit	27,81
MIF12GMR4	HGM/HGE 125 4P için mekanik kilit	27,81
MIF25GM3	HGM/HGE 250 3P için mekanik kilit	30,57
MIF25GMR4	HGM/HGE 250 4P için mekanik kilit	30,57
MIF 40GM 3	HGM/HGE 400 4P için mekanik kilit	46,33
MIF 40GM R4	HGM/HGE 400 4P için mekanik kilit	46,33
MIF 80GM 3	HGM/HGE 800 4P için mekanik kilit	55,58
MIF 80GM R4	HGM/HGE 800 4P için mekanik kilit	55,58
Kurma Kolu Kilidi		
PLD10GM	HGM/HGE 100~250 için kilit	16,69
PLD 40GM	HGM/HGE 400~800 için kilit	18,52
Motor Mekanizması		
MOT10GM	HGM/HGE 100 uyumlu motor mekanizması 230 V AC	515,09
MOT12GM	HGM/HGE 125 uyumlu motor mekanizması 230 V AC	515,09
MOT25GM	HGM/HGE 250 uyumlu motor mekanizması 230 V AC	515,09
MOT40GM	HGM/HGE 400 uyumlu motor mekanizması 230 V AC	708,70
MOT80GM	HGM/HGE 800 uyumlu motor mekanizması 230 V AC	796,71

* Motor mekanizmaları standart 220 VAC'dır.

* Kaçak akımlı kompakt şalterlere harici olarak açtırma bobini takılamamaktır.

* Kaçak akım korumalı kompakt şalterlerde açtırma-düşük gerilim bobini (SHT,UVT) 250A altı için takılamamaktadır.

* Açtırma bobinleri ve düşük gerilim bobinleri için farklı voltaj değerleri hakkında bilgi alınır.

ICS= ICU%100

Sabit Tip



Ürün Kodu	Anma Akımı (A)	Kesme Şekli	Manyetik Ayar	Kesme Kap. 380 VAC (kA)	Min. Sip. Adedi	Birim Fiyat (\$)
HGE125H-4P16	16	T/M	10xIn(Sabit)	38	1	220,45
HGE125H-4P20	20	T/M	10xIn(Sabit)	38	1	220,45
HGE125H-4P25	25	T/M	10xIn(Sabit)	38	1	220,45
HGE125H-4P32	32	T/M	10xIn(Sabit)	38	1	220,45
HGE125H-4P40	40	T/M	10xIn(Sabit)	38	1	220,45
HGE125H-4P50	50	T/M	10xIn(Sabit)	38	1	220,45
HGE125H-4P63	63	T/M	10xIn(Sabit)	38	1	220,45
HGE125H-4P80	80	T/M	10xIn(Sabit)	38	1	220,45
HGE125H-4P100	100	T/M	10xIn(Sabit)	38	1	220,45
HGE125H-4P125	125	T/M	10xIn(Sabit)	38	1	264,54
HGE250H-4P160	160	T/M	10xIn(Sabit)	38	1	341,69
HGE250H-4P200	200	T/M	10xIn(Sabit)	38	1	396,80
HGE250H-4P250	250	T/M	10xIn(Sabit)	38	1	396,80
HGE400S-4P300	300	T/M	10xIn(Sabit)	65	1	751,53
HGE400S-4P400	400	T/M	10xIn(Sabit)	65	1	761,55

* Ayarlanabilir 0,1/0,3/0,5/1A hassasiyet

* Ayarlanabilir 0/200/500/1000 ms zaman gecikmeli

* Kaçak akım korumalı kompakt şalterlerde açtırma-düşük gerilim bobini (SHT,UVT) 250A altı için takılamamaktadır.

HGP Serisi, Yüksek Kesme Kapasiteli Kompakt Şalterler



ICS= ICU%100



Termik Ayarlı, Manyetik Ayarlı (3 Kutuplu)

Ayarlı

Ürün Kodu	Anma Akımı (A)	Termik Ayar Sahası	Manyetik Ayar Sahası	Kesme Şekli	Kesme Kap. 380 VAC Icu (KA)	Min. Sip. Adedi	Birim Fiyat (\$)
HGP125DF3PT4S40F	40	32-40	10 In	T/M	50	1	269,98
HGP125DF3PT4S50F	50	40-50	10 In	T/M	50	1	269,98
HGP125DF3PT4S63F	63	50-63	10 In	T/M	50	1	269,98
HGP125DF3PT4S80F	80	64-80	10 In	T/M	50	1	269,98
HGP125DF3PT4S100F	100	80-100	10 In	T/M	50	1	269,98
HGP250F3PT4S125H	125	88-125	(5-10) In	T/M	50	1	279,63
HGP250F3PT4S160H	160	112-160	(5-10) In	T/M	50	1	279,63
HGP250F3PT4S200H	200	160-200	(5-10) In	T/M	50	1	279,63
HGP250F3PT4S250H	250	200-250	(5-10) In	T/M	50	1	279,63
HGP400F3PT4S300H	300	240-300	(5-10) In	T/M	50	1	565,81
HGP400F3PT4S400H	400	320-400	(5-10) In	T/M	50	1	565,81
HGP630F3PT4S500H	500	400-500	(5-10) In	T/M	50	1	605,15
HGP630F3PT4S630H	630	500-630	(5-10) In	T/M	50	1	605,15
HGP800F3PT4S800H	800	640-800	(5-10) In	T/M	50	1	1.146,84
HGP400S3PT4S300H	300	240-300	(5-10) In	T/M	85	1	617,68
HGP400S3PT4S350H	350	280-350	(5-10) In	T/M	85	1	617,68
HGP400S3PT4S400H	400	320-400	(5-10) In	T/M	85	1	617,68
HGP630S3PT4S500H	500	400-500	(5-10) In	T/M	85	1	661,46
HGP630S3PT4S630H	630	500-630	(5-10) In	T/M	85	1	661,46
HGP800S3PT4S800H	800	640-800	(5-10) In	T/M	85	1	1.240,17

Termik Ayarlı, Manyetik Ayarlı (4 Kutup)

Ayarlı

Ürün Kodu	Anma Akımı (A)	Termik Ayar Sahası	Manyetik Ayar Sahası	Kesme Şekli	Kesme Kap. 380 VAC Icu (KA)	Min. Sip. Adedi	Birim Fiyat (\$)
HGP125DF4PT4S40F	40	32-40	10 In	T/M	50	1	359,98
HGP125DF4PT4S50F	50	40-50	10 In	T/M	50	1	359,98
HGP125DF4PT4S63F	63	50-63	10 In	T/M	50	1	359,98
HGP125DF4PT4S80F	80	64-80	10 In	T/M	50	1	359,98
HGP125DF4PT4S100F	100	80-100	10 In	T/M	50	1	359,98
HGP250F4PT4S125H	125	88-125	(5-10) In	T/M	50	1	372,83
HGP250F4PT4S160H	160	112-160	(5-10) In	T/M	50	1	372,83
HGP250F4PT4S200H	200	160-200	(5-10) In	T/M	50	1	372,83
HGP250F4PT4S250H	250	200-250	(5-10) In	T/M	50	1	372,83
HGP400F4PT4S300H	300	240-300	(5-10) In	T/M	50	1	754,41
HGP400F4PT4S400H	400	320-400	(5-10) In	T/M	50	1	754,41
HGP630F4PT4S500H	500	400-500	(5-10) In	T/M	50	1	806,86
HGP630F4PT4S630H	630	500-630	(5-10) In	T/M	50	1	806,86
HGP800F4PT4S800H	800	640-800	(5-10) In	T/M	50	1	1.529,12
HGP400S4PT4S300H	300	240-300	(5-10) In	T/M	85	1	823,57
HGP400S4PT4S350H	350	280-350	(5-10) In	T/M	85	1	823,57
HGP400S4PT4S400H	400	320-400	(5-10) In	T/M	85	1	823,57
HGP630S4PT4S500H	500	400-500	(5-10) In	T/M	85	1	881,95
HGP630S4PT4S630H	630	500-630	(5-10) In	T/M	85	1	881,95
HGP800S4PT4S800H	800	640-800	(5-10) In	T/M	85	1	1.653,58

* HGP Serisi Kompakt Şalterlerde 85kA, 100kA ve 150kA Kesme Kapasiteleri için bilgi isteyiniz.



Ürün Kodu	Açıklama	Birim Fiyat (\$)
Yardımcı Kontak Bloğu		
AUX16GPR1	HGP 125D/160D/250 kasası için yardımcı kontak bloğu	17,79
AUX63GPL1	HGP 400/630/800 kasası için yardımcı kontak bloğu	19,46
Alarm Konağı		
ALT16GPL1	HGP 125D/160D kasası için alarm konağı	17,79
ALT25GPL1	HGP 250 kasası için alarm konağı	19,46
ALT63GPR1	HGP 400/630/800 kasası için alarm konağı	23,16
Açtırma Bobini		
SHT16GPAC200-230	HGP 125D/160D kasası için açtırma bobini	50,04
SHT25GP-GAC200-230	HGP 250 kasası için açtırma bobini	51,10
SHT63GPAC200-230	HGP 400/630/800 kasası için açtırma bobini	53,74
Düşük Gerilim Bobini		
UVT16GPAC200-230V	HGP 125D/160D kasası için düşük gerilim bobini	83,38
UVT 25GP-GAC200-230V	HGP 250 kasası için düşük gerilim bobini	112,09
UVT 63GPAC200-230V	HGP 400/630/800 kasası için düşük gerilim bobini	114,87
Kurma Kolu		
TFG16GPU	HGP 125D/160D kasası için kurma kolu	42,63
TF 25GPU	HGP 250 kasası için kurma kolu	46,33
TFG63GPU	HGP 400/630 kasası için kurma kolu	138,97
TFG80GPU	HGP 800 kasası için kurma kolu	142,67
Uzatma Tipi Kurma Kolu		
TFH16GPU	HGP 125D/160D kasası için uzatmalı kurma kolu	57,45
TFH25GPU	HGP 250 kasası için uzatmalı kurma kolu	57,45
TFH63GPU	HGP 400/630 kasası için uzatmalı kurma kolu	155,64
TFH80GPU	HGP 800 kasası için uzatmalı kurma kolu	159,35
Mekanik Kilit		
MIF16GP3	3 Kutup HGP 125D/160D kasası için mekanik kilit	50,04
MIF16GPR4	4 Kutup HGP 125D/160D kasası için mekanik kilit	59,29
MIF25GP3	3 Kutup HGP 250 kasası için mekanik kilit	53,74
MIF25GPR4	4 Kutup HGP 250 kasası için mekanik kilit	61,15
MIF63GP3	3 Kutup HGP 400/630 kasası için mekanik kilit	64,86
MIF63GPR4	4 Kutup HGP 400/630 kasası için mekanik kilit	68,56
MIF80GP3	3 Kutup HGP 800 kasası için mekanik kilit	72,27
MIF80GPR4	4 Kutup HGP 800 kasası için mekanik kilit	74,12
Kurma Kolu Kilidi		
PLD16GP	HGP 125D/160D Kasası için kurma kolu kilidi	16,69
PLD25GP	HGP 250 Kasası için kurma kolu kilidi	18,52
PLD63GP	HGP 400/630 Kasası için kurma kolu kilidi	22,24
PLD80GP	HGP 800 Kasası için kurma kolu kilidi	25,94
Motor Mekanizması		
MOT16GPAC/DC 240	HGP 125D/160D Uyumlu Motor Mekanizması	515,09
MOT25GPAC/DC 240	HGP 250 Uyumlu Motor Mekanizması	528,06
MOT63GPAC/DC 240	HGP 400/630 Uyumlu Motor Mekanizması	708,70
MOT80GPAC/DC 240	HGP 800 Uyumlu Motor Mekanizması	796,71

* Motor mekanizmaları standart 220 VAC'dir.

AÇIK TİP GÜÇ ŞALTERLERİ HGN-HGS SERİSİ (630A - 6300A)

HGN / HGS (630 - 6300 A)
Yeni Seri Açık Tip Devre Kesiciler



Ürün Tipi



A Kasa [85 kA]
HGS 630 ~ 1.600 A
HGN 630 ~ 2.000 A



B Kasa [100 kA]
HGS 2.000 ~ 3.200 A
HGN 630 ~ 4.000 A



C Kasa [100 kA]
HGN 3.200 ~ 5.000 A



D Kasa [150 kA]
HGN 4.000 ~ 6.300 A

İleri Seviye Fonksiyonlu Koruyucu Açırma Rölesi (OCR)

Temel koruma fonksiyonlarından farklı olarak, OCR (Aşırı Akım Rölesi (Açırma rölesi)), sıcaklık takibi, arıza kayıt ve saklama gibi elektriksel güç izleme fonksiyonları ile desteklenerek istikrarlı elektriksel güç sağlanmasına olanak tanımaktadır.

Model	N Tipi	A Tipi	P Tipi	H Tipi
Dış Görünüş				
Ana Özellikler	<ul style="list-style-type: none"> Aşırı akım koruması (L/S/I/G) Dünyanın ilk NFC uygulaması Hata kayıt (10) ve Dalgaformu (4 çevrim, haberleşme ile kontrol) cep telefonu uygulamasına aktarılabilir 	<ul style="list-style-type: none"> Aşırı akım koruması (L/S/I/G) Kendinden besleme Kişisel sürüekli güç kontağı Hata kayıt (256) ve Dalgaformu (4 çevrim, haberleşme ile kontrol) Haberleşme (MODBUS), Dış Topraklama CT/ Toprak Kaçağı ZCT kullanılabilir 	<ul style="list-style-type: none"> Aşırı akım koruması (L/S/I/G) Dışardan besleme Kişisel sürüekli güç kontağı Hata kayıt (256) ve Dalgaformu (4 çevrim, haberleşme ile kontrol) Aşırı-Gerilim, Düşük-Gerilim, Güç, Güç Faktörü, Enerji Görüntüleme 	<ul style="list-style-type: none"> Aşırı akım koruması (L/S/I/G) Dışardan besleme Kişisel sürüekli güç kontağı Hata kayıt (256) ve Dalgaformu (4 çevrim, haberleşme ile kontrol) L/S/I/G Dakika Akım Ayarı Gerilim/Akım Harmonikleri (1. - 63. Harmonik) analizi 3 Faz Dalgaformu izlenmesi

Alınan Standartlar ve Sertifikalar

- KS Sertifikası: KS C 4620
- CB Sertifikası (DEKRA, KERI): IEC 60947-4-1,2
- CE İşareti
- CCC Sertifikası
- Gemi Sertifikası: LR, ABS, KR, BV, DNV-GL, NK, RINA, RS



HGN/HGS Serisi Açık Tip Şalterleri (3 Kutuplu) 630-6300



Ürün Kodu	Anma Akımı (A)	Ayar Sahası	Kesme Kap. 380 VAC Icu (kA)	Min. Sip. Adedi	Birim Fiyat (\$)
-----------	----------------	-------------	-----------------------------	-----------------	------------------

Sabit Tip (Elle Kurmalı) 3 Kutuplu

HGS06A-3HM0	630	250-630	65	1	2.532,61
HGS08A-3HM0	800	320-800	65	1	2.629,52
HGS10A-3HM0	1000	400-1000	65	1	2.844,08
HGS12A-3HM0	1200	500-1250	65	1	2.992,31
HGS16A-3HM0	1600	640-1600	65	1	3.244,65
HGS20B-3HM0	2000	800-2000	85	1	3.957,05
HGS25B-3HM0	2500	1000-2500	85	1	4.736,17
HGS32B-3HM0	3200	1280-3200	85	1	5.187,88
HGN40B-3HM0	4000	1600-4000	100	1	8.037,32
HGN50C-3HM0	5000	2000-5000	100	1	12.738,10
HGN63D-3HM0	6300	2500-6300	150	1	20.406,88

Sabit Tip (Motorlu) 3 Kutuplu

HGS06A-3HM2	630	250-630	65	1	3.090,32
HGS08A-3HM2	800	320-800	65	1	3.187,22
HGS10A-3HM2	1000	400-1000	65	1	3.401,77
HGS12A-3HM2	1200	500-1250	65	1	3.550,00
HGS16A-3HM2	1600	640-1600	65	1	3.802,35
HGS20B-3HM2	2000	800-2000	85	1	4.514,75
HGS25B-3HM2	2500	1000-2500	85	1	5.293,86
HGS32B-3HM2	3200	1280-3200	85	1	5.745,58
HGN40B-3HM2	4000	1600-4000	100	1	8.595,00
HGN50C-3HM2	5000	2000-5000	100	1	13.295,79
HGN63D-3HM2	6300	2500-6300	150	1	20.964,58

Çekmeceli (Elle Kurmalı) 3 Kutuplu

HGS06A-3BM0	630	250-630	65	1	3.395,57
HGS08A-3BM0	800	320-800	65	1	3.566,67
HGS10A-3BM0	1000	400-1000	65	1	3.807,54
HGS12A-3BM0	1200	500-1250	65	1	4.029,88
HGS16A-3BM0	1600	640-1600	65	1	4.252,22
HGS20B-3BM0	2000	800-2000	85	1	5.549,18
HGS25B-3BM0	2500	1000-2500	85	1	7.142,61
HGS32B-3BM0	3200	1280-3200	85	1	8.458,10
HGN40B-3BM0	4000	1600-4000	100	1	11.670,88
HGN50C-3BM0	5000	2000-5000	100	1	18.843,10
HGN63D-3BM0	6300	2500-6300	150	1	31.027,19

Çekmeceli (Motorlu) 3 Kutuplu

HGS06A-3BM2	630	250-630	65	1	3.920,55
HGS08A-3BM2	800	320-800	65	1	4.124,36
HGS10A-3BM2	1000	400-1000	65	1	4.365,23
HGS12A-3BM2	1200	500-1250	65	1	4.587,57
HGS16A-3BM2	1600	640-1600	65	1	4.809,90
HGS20B-3BM2	2000	800-2000	85	1	6.106,87
HGS25B-3BM2	2500	1000-2500	85	1	7.700,30
HGS32B-3BM2	3200	1280-3200	85	1	9.015,79
HGN40B-3BM2	4000	1600-4000	100	1	12.228,57
HGN50C-3BM2	5000	2000-5000	100	1	19.400,81
HGN63D-3BM2	6300	2500-6300	150	1	31.584,91

- 1- Motorlu tip devre kesicilerde 220V motor mekanizmasının yanında, 220V açtırma ve 220V kapama bobinleride beraber gönderilir.
- 2- Bütün ürünler Yatay (H) bağlantılı olarak teslim edilmektedir. Dikey bağlantı için, bağlantı parçasını 90° çevirmeniz gerekmektedir.
V- Dikey bağlantı
T- Karma bağlantı (HV) üst taraf yatay (H), alt taraf Dikey (V)
L- Karma bağlantı (VH) üst taraf dikey (V), alt taraf Yatay (H)
- 3- Önden bağlantı (F)
- 4- Bütün ürünlerde yardımcı kontaklar devre kesici ile beraber sevk edilmektedir.

HGN/HGS Serisi Açık Tip Şalterleri (4 Kutuplu) 630-6300A



Ürün Kodu	Anma Akımı (A)	Ayar Sahası	Kesme Kap. 380 VAC Icu (kA)	Min. Sip. Adedi	Birim Fiyat (\$)
-----------	----------------	-------------	-----------------------------	-----------------	------------------

Sabit Tip (Elle Kurmalı) 4 Kutuplu

HGS06A-4HM0	630	250-630	65	1	3.238,93
HGS08A-4HM0	800	320-800	65	1	3.362,96
HGS10A-4HM0	1000	400-1000	65	1	3.637,37
HGS12A-4HM0	1200	500-1250	65	1	3.826,82
HGS16A-4HM0	1600	640-1600	65	1	4.149,74
HGS20B-4HM0	2000	800-2000	85	1	5.060,72
HGS25B-4HM0	2500	1000-2500	85	1	6.057,18
HGS32B-4HM0	3200	1280-3200	85	1	6.634,78
HGN40B-4HM0	4000	1600-4000	100	1	10.279,07
HGN50C-4HM0	5000	2000-5000	100	1	16.290,95
HGN63D-4HM0	6300	2500-6300	150	1	26.098,53

Sabit Tip (Motorlu) 4 Kutuplu

HGS06A-4HM2	630	250-630	65	1	3.952,29
HGS08A-4HM2	800	320-800	65	1	4.076,16
HGS10A-4HM2	1000	400-1000	65	1	4.350,56
HGS12A-4HM2	1200	500-1250	65	1	4.540,17
HGS16A-4HM2	1600	640-1600	65	1	4.862,91
HGS20B-4HM2	2000	800-2000	85	1	5.773,91
HGS25B-4HM2	2500	1000-2500	85	1	6.770,38
HGS32B-4HM2	3200	1280-3200	85	1	7.348,13
HGN40B-4HM2	4000	1600-4000	100	1	10.992,26
HGN50C-4HM2	5000	2000-5000	100	1	17.004,13
HGN63D-4HM2	6300	2500-6300	150	1	26.811,90

Çekmeceli (Elle Kurmalı) 4 Kutuplu

HGS06A-4BM0	630	250-630	65	1	4.300,80
HGS08A-4BM0	800	320-800	65	1	4.561,50
HGS10A-4BM0	1000	400-1000	65	1	4.869,50
HGS12A-4BM0	1200	500-1250	65	1	5.153,85
HGS16A-4BM0	1600	640-1600	65	1	5.438,20
HGS20B-4BM0	2000	800-2000	85	1	7.096,85
HGS25B-4BM0	2500	1000-2500	85	1	9.134,75
HGS32B-4BM0	3200	1280-3200	85	1	10.817,20
HGN40B-4BM0	4000	1600-4000	100	1	14.926,07
HGN50C-4BM0	5000	2000-5000	100	1	24.098,67
HGN63D-4BM0	6300	2500-6300	150	1	39.681,05

Çekmeceli (Motorlu) 4 Kutuplu

HGS06A-4BM2	630	250-630	65	1	5.013,99
HGS08A-4BM2	800	320-800	65	1	5.274,70
HGS10A-4BM2	1000	400-1000	65	1	5.582,69
HGS12A-4BM2	1200	500-1250	65	1	5.867,04
HGS16A-4BM2	1600	640-1600	65	1	6.151,39
HGS20B-4BM2	2000	800-2000	85	1	7.810,20
HGS25B-4BM2	2500	1000-2500	85	1	9.847,94
HGS32B-4BM2	3200	1280-3200	85	1	11.530,40
HGN40B-4BM2	4000	1600-4000	100	1	15.639,25
HGN50C-4BM2	5000	2000-5000	100	1	24.811,85
HGN63D-4BM2	6300	2500-6300	150	1	40.394,23



HGN - HGS Serisi Açık Tip Şalterler Aksesuar ve Yedek Parçalar

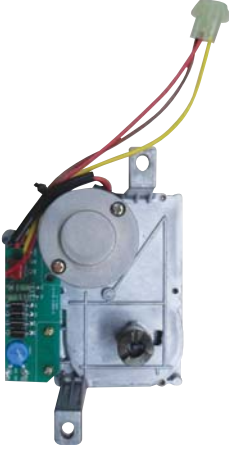

Ürün Kodu	Açıklama	Birim Fiyat (\$)
HGNS M2	Motor 230 V AC	277,93
HGNS M2U	Elektronik kart kontrollü motor 230 V AC	390,95
HGNS MCU	Motor kontrol ünitesi	46,33

Bobinler

Ürün Kodu	Açıklama	Birim Fiyat (\$)
HGNS S2	Açtırma bobini - 230 V AC	83,38
HGNS C2	Kapama bobini - 230 V AC	83,38
HGNS U2	Ani düşük gerilim bobini - 230 V AC	185,28
HGNS V2	Zaman gecikmeli düşük gerilim bobini - 230 V AC	259,40
HGNS UT2	Zaman gecikme modülü	222,34

Test Cihazları

HGNS OC	APR/Test kalibrasyon cihazı	4.539,39
---------	-----------------------------	----------

Diğer Aksesuarlar

Ürün Kodu	Açıklama	Birim Fiyat (\$)
HGNS AB	Kilitleme anahtarı	55,58
HGNS AM	On-Off düğme koruyucu ve anahtarı	18,52
HGNS AD	Açma kapama sayacı	55,58
HGNS AL	Taşıma kulpu ve kancası	46,33
HGNS CTD2	Kondansatörlü kesme ünitesi	148,23
HGNS AQ	Pozisyon anahtarı (devrede:1K Testte:1K)	120,44
HGNS AFB	Sabitleme bloğu	111,18
HGNS AK	Kısa devre kontağı	64,86
HGNS A5J	Yardımcı kontak	166,75
HGNS B6	NA kontak (motor için)	46,33
HGNS AW	Yanlış yerleşim koruma cihazı	55,58
HGNS AG	Kapı flanşı	37,06



Mekanik Kilitleme

Ürün Kodu	Açıklama	Birim Fiyat (\$)
HGNS FWB1B	Mekanik kilitleme (B kasası sabit tip 2 yollu)	1.111,69
HGNS FAWB1	Mekanik kilitleme (A/C kasası sabit tip 2 yollu)	1.296,98

Otomatik Transfer Panosu

Ürün Kodu	Açıklama	Birim Fiyat (\$)
HGNS ATS	Otomatik transfer panosu	2.779,23

VAKUMLU KONTAKTÖR VE VAKUMLU DEVRE KESİCİLER





Sabit Sigorta Yuvasız Sürekli Enerjili Bobinli

Ürün Kodu	Anma Akımı (A)	Anma Voltajı (KV)	Birim Fiyat (\$)
UVC32CF 4000000	200	3,6kV	5,500.00
UVC62CF 4000000	200	7,2kV	6,100.00
UVC34CF 4000000	400	3,6kV	5,500.00
UVC64CF 4000000	400	7,2kV	6,100.00

F Tipi Çekmeceli Sigorta Yuvalı Sürekli Enerjili Bobinli

Ürün Kodu	Anma Akımı (A)	Anma Voltajı (KV)	Birim Fiyat (\$)
UVC32CD 4F16000	200	3,6kV	8,235.00
UVC62CD 4F16000	200	7,2kV	9,400.00
UVC34CD 4F16000	400	3,6kV	8,235.00
UVC64CD 4F16000	400	7,2kV	9,400.00

M Tipi Çekmeceli Sigorta Yuvalı Sürekli Enerjili Bobinli

Ürün Kodu	Anma Akımı (A)	Anma Voltajı (KV)	Birim Fiyat (\$)
UVC32CD 4M16000	200	3,6kV	14,877.00
UVC62CD 4M16000	200	7,2kV	17,108.00
UVC34CD 4M16000	400	3,6kV	14,877.00
UVC64CD 4M16000	400	7,2kV	17,108.00

Sabit Sigorta Yuvasız Kilitlemeli Bobinli

Ürün Kodu	Anma Akımı (A)	Anma Voltajı (KV)	Birim Fiyat (\$)
UVC32LF 4000000 AF	200	3,6kV	6,376.00
UVC62LF 4000000 AF	200	7,2kV	7,300.00
UVC34LF 4000000 AF	400	3,6kV	6,376.00
UVC64LF 4000000 AF	400	7,2kV	7,300.00

F Tipi Çekmeceli Sigorta Yuvalı Kilitlemeli Bobinli

Ürün Kodu	Anma Akımı (A)	Anma Voltajı (KV)	Birim Fiyat (\$)
UVC32LD 4F16000 AF	200	3,6kV	8,502.00
UVC62LD 4F16000 AF	200	7,2kV	9,700.00
UVC34LD 4F16000 AF	400	3,6kV	8,502.00
UVC64LD 4F16000 AF	400	7,2kV	9,700.00

M Tipi Çekmeceli Sigorta Yuvalı Kilitlemeli Bobinli

Ürün Kodu	Anma Akımı (A)	Anma Voltajı (KV)	Birim Fiyat (\$)
UVC32LD 4M16000 AF	200	3,6kV	14,877.00
UVC62LD 4M16000 AF	200	7,2kV	17,100.00
UVC34LD 4M16000 AF	400	3,6kV	14,877.00
UVC64LD 4M16000 AF	400	7,2kV	17,100.00

* Kilitleme tip bobin mekanizması farklı bobin voltajları ve diğer talepleriniz için firmamızla irtibata geçiniz.

Sabit Tip Vakumlu Devre Kesici



Ürün Kodu	Anma Akımı (A)	Anma Voltajı (kV)	Kısa Devre Kesme Kapasitesi (kA)	Birim Fiyat (\$)
HGV1141CXA666C	630	7.2	25	11,829.00
HGV1142CXA666C	1250	7.2	25	9,913.00
HGV1144FXA666C	2000	7.2	25	15,002.00
HGV2141CXA666C	630	12	25	11,829.00
HGV2142CXA666C	1250	12	25	11,895.00
HGV2144FXA666C	2000	12	25	15,004.00
HGV3141CXA666C	630	17.5	25	11,988.00
HGV3142CXA666C	1250	17.5	25	12,052.00
HGV3144FXA666C	2000	17.5	25	15,172.00
HGV6111FXA666C	630	24/25,8	12.5	13,070.00
HGV6112FXA666C	1250	24/25,8	12.5	13,135.00
HGV6141FXA666C	630	24/25,8	25	13,070.00
HGV6142FXA666C	1250	24/25,8	25	13,135.00
HGV6144FXA666C	2000	24/25,8	25	15,487.00
HVF7142XA999C	1250	36	25	24,927.00
HVF7144XA999C	2000	36	25	25,270.00
HVF7052XA999C	1250	36	31.5	29,740.00
HVF7054XA999C	2000	36	31.5	33,274.00
HVF7057XA999C	3150	36	31.5	33,766.00

Çekmeceli Tip Vakumlu Devre Kesici



Ürün Kodu	Anma Akımı (A)	Anma Voltajı (kV)	Kısa Devre Kesme Kapasitesi (kA)	Birim Fiyat (\$)
HGV1141CES666C	630	7.2	25	15,465.00
HGV1142CES666C	1250	7.2	25	15,885.00
HGV1144FGS666C	2000	7.2	25	23,661.00
HGV2141CES666C	630	12	25	16,402.00
HGV2142CES666C	1250	12	25	17,011.00
HGV2144FGS666C	2000	12	25	23,892.00
HGV3141CES666C	630	17.5	25	17,184.00
HGV3142CES666C	1250	17.5	25	16,614.00
HGV3144FGS666C	2000	17.5	25	24,063.00
HGV6111FES666C	630	24/25,8	12.5	18,529.00
HGV6112FES666C	1250	24/25,8	12.5	18,111.00
HGV6141FES666C	630	24/25,8	25	18,529.00
HGV6142FES666C	1250	24/25,8	25	18,111.00
HGV6144FES666C	2000	24/25,8	25	26,270.00
HVF7142GS999C	1250	36	25	51,128.00
HVF7144GS999C	2000	36	25	54,612.00
HVF7052GS999C	1250	36	31.5	62,838.00
HVF7054GS999C	2000	36	31.5	73,095.00
HVF7057GS999C	3150	36	31.5	95,034.00

Transformatörler için Şalter Seçim Kablosu

Transformatör Gücü S (kVA)	Nominal Akım In (A)	Kısa Devre Gerilimi UK (%)	3 Fazlı Kısa Devre Akımı Isc (rms) (kA)	Kullanılması Gereken Hyundai Şalter Tipi ve Amperajı
40	58	4.5	25	UAB103S-63A
50	72	4.5	25	UAB103S-80A
63	91	4.5	25	UAB103S-100A
80	115	4.5	25	UCB253S-125A
100	144	4.5	25	UCB253S-160A
125	180	4.5	25	UCB253S-200A
160	231	4.5	25	UCB253S-250A
200	289	4.5	25	UCB403S-400A
250	361	4.5	25	UCB403S-400A
315	455	4.5	12.5	UCB633R-630A
400	578	4.5	12.5	UCB633R-630A
500	723	4.5	25	UCB803S-800A
630	910	4.5	25	UCB1003S-1000A
800	1156	6	25	UCB1253S-1250A
1000	1445	6	25	HGS/HGN 16 1600A
1250	1805	6	25	HGS/HGN 20 2000A
1600	2312	6	31.5	HGS/HGN 25 2500A
2000	2900	6	31.5	HGS/HGN 32 3200A
2500	3600	6	31.5	HGN 4000A

- * Yukarıda verilen değerler ideal çalışma şartlarına göre düzenlenmiştir ve bilgi amaçlıdır. Ağır çalışma şartlarında yıldız kontaktörünü de pilot ve üçgen kontaktörü ile aynı seçiniz.
- * Tabloda belirtilen motor akımları ve seçim tablosu motor devrinin 1500 d/d olduğu kabul edilerek düzenlenmiştir. Farklı motor devirleri için ayrıca bilgi almanız tavsiye edilir.

Yıldız / Üçgen Yol Vermede Kontaktör Seçim Tablosu

Motor kW	380/400V A	Hat (Pilot) Kontaktörü	Üçgen Kontaktörü	Yıldız Kontaktörü	Termik Röle
5.5	12	HGC25	HGC25	HGC25	HGT40
7.5	18	HGC25	HGC25	HGC25	HGT40
11	22	HGC25	HGC25	HGC25	HGT40
15	32	HGC32	HGC32	HGC25	HGT40
18.5	40	HGC40	HGC40	HGC25	HGT40
22	50	HGC40	HGC40	HGC32	HGT40
30	65	HGC50	HGC50	HGC40	HGT65K
37	80	HGC75	HGC75	HGC40	HGT100K
45	90	HGC75	HGC75	HGC40	HGT100K
55	110	HGC100	HGC100	HGC50	HGT100K
75	150	HGC115	HGC115	HGC65	HGT150K
90	180	HGC130	HGC130	HGC100	HGT150K
110	220	HGC150	HGC150	HGC115	HGT150K
132	260	HGC185	HGC185	HGC115	HGT265K
160	300	HGC225	HGC225	HGC130	HGT265K
250	500	HGC400	HGC400	HGC225	HGT500K
300	560	HGC400	HGC400	HGC300	HGT500K

- * Yukarıda verilen değerler ideal çalışma şartlarına göre düzenlenmiştir ve bilgi amaçlıdır. Ağır çalışma şartlarında yıldız kontaktörünü de pilot ve üçgen kontaktörü ile aynı seçiniz. Gerekirse bir üst kombinasyonu kullanınız.
- * Tabloda belirtilen motor akımları ve seçim tablosu motor devrinin 1500 d/d olduğu kabul edilerek düzenlenmiştir. Farklı motor devirleri için ayrıca bilgi almanız tavsiye edilir.

HGC9 / HGC12 / HGC18

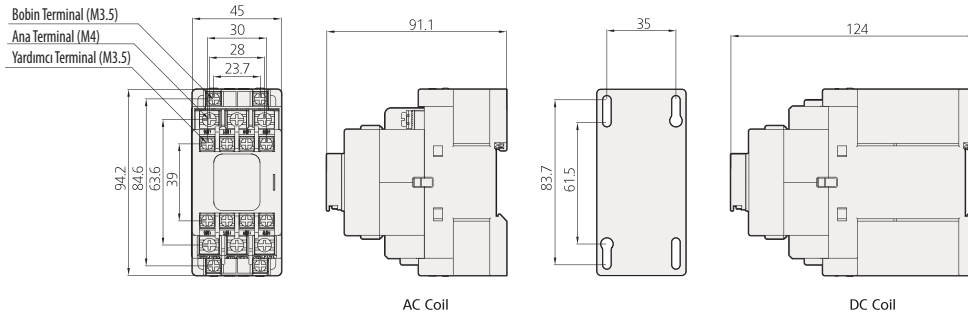

HGC25 / HGC32 / HGC40

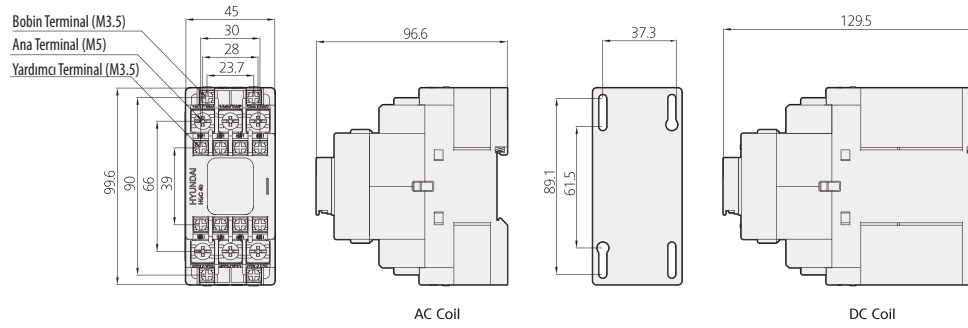

HGC50 / HGC65(AC/DC)

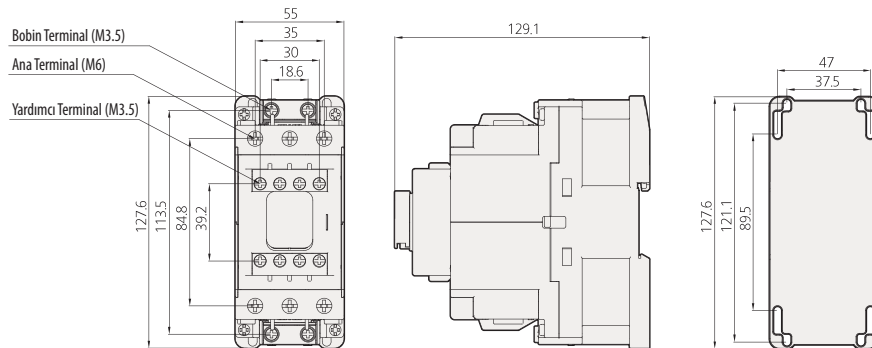

HGC75 / HGC85 / HGC100 (AC/DC)

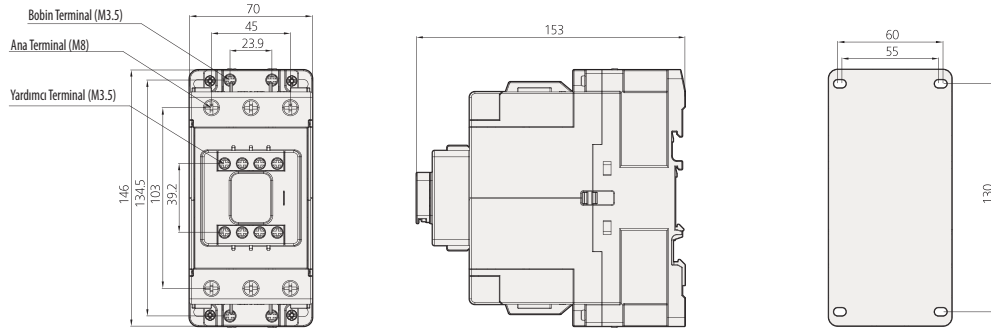

HGC115 / HGC130 / HGC150

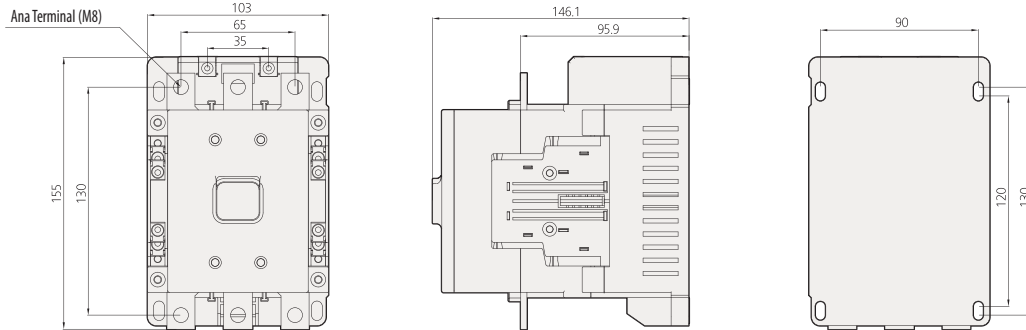

HGC185 / HGC225 / HGC265

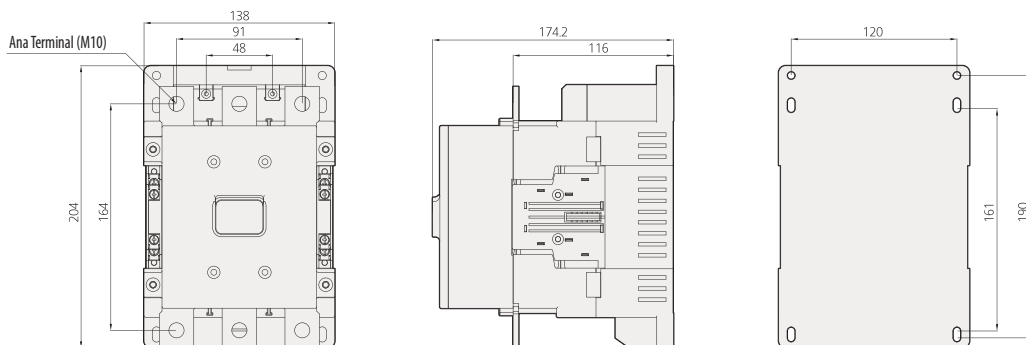

HGC300 / HGC400 / HGC500

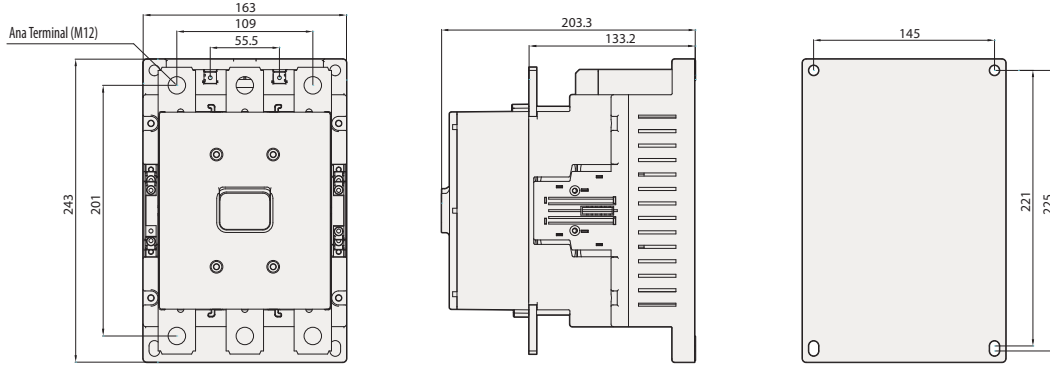

HGC630 / HGC800

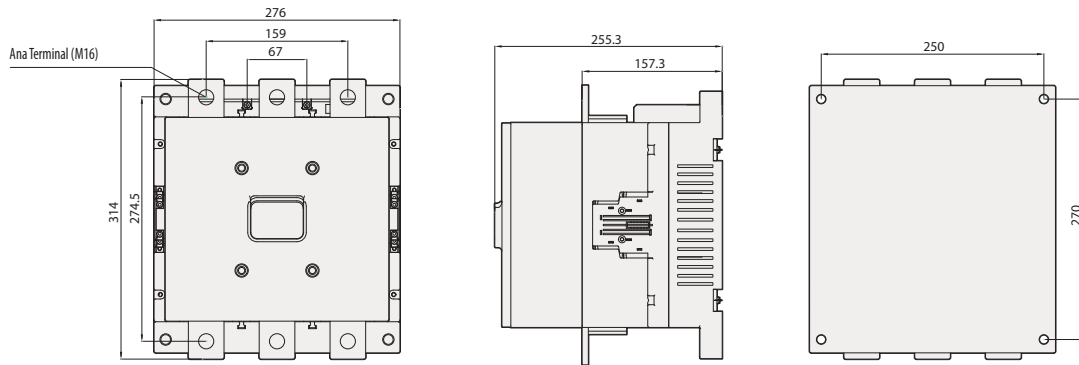

HGR (AC)

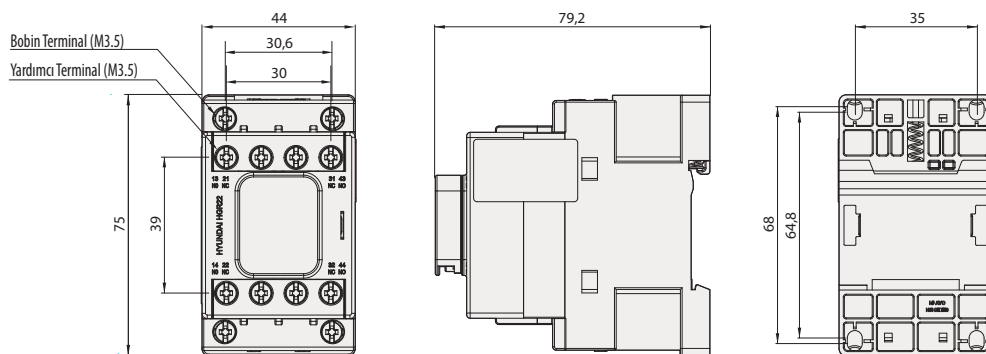

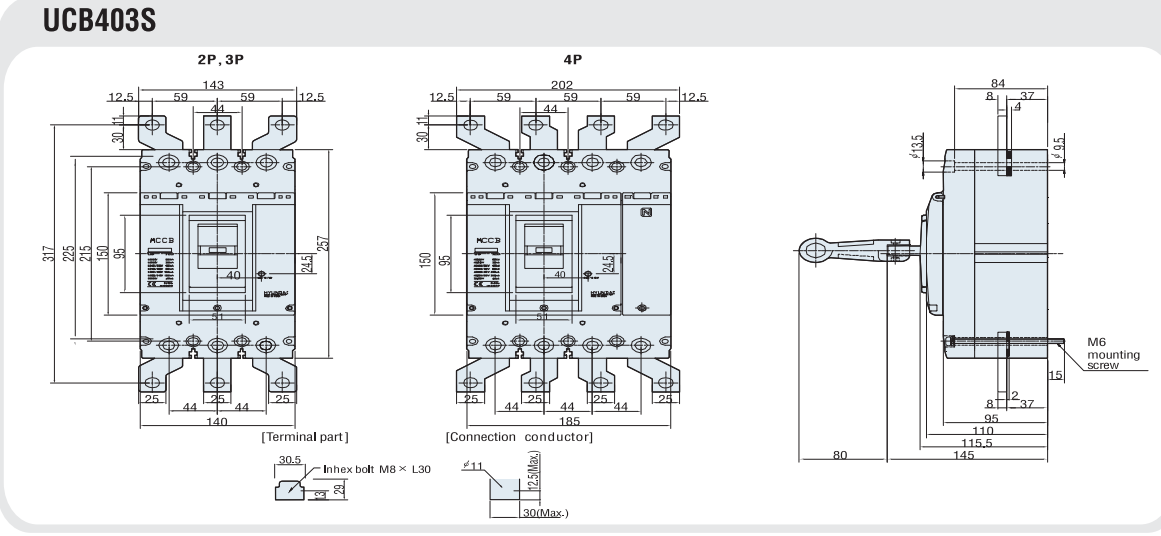
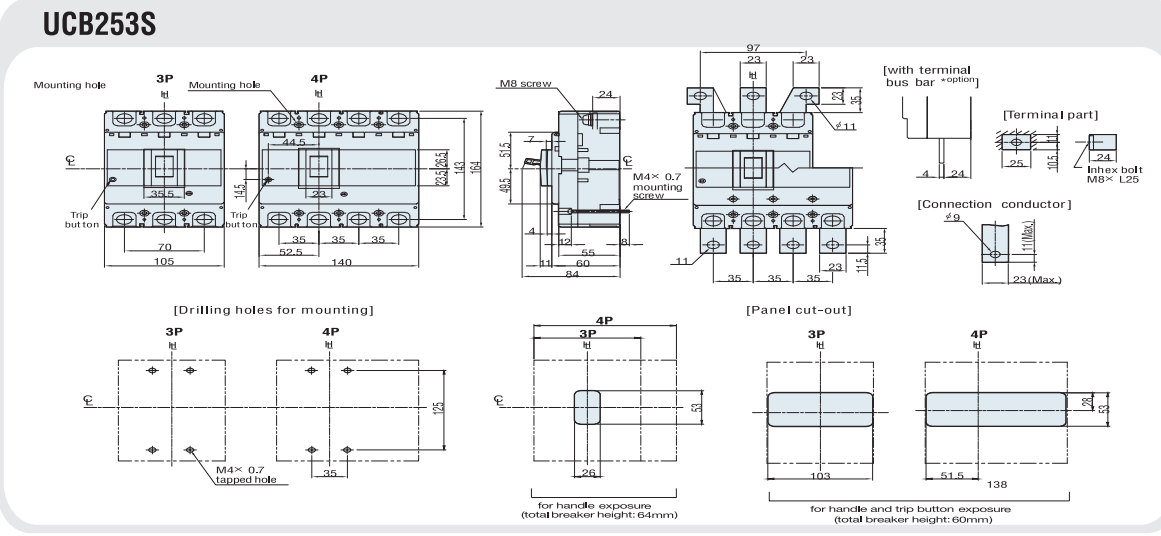
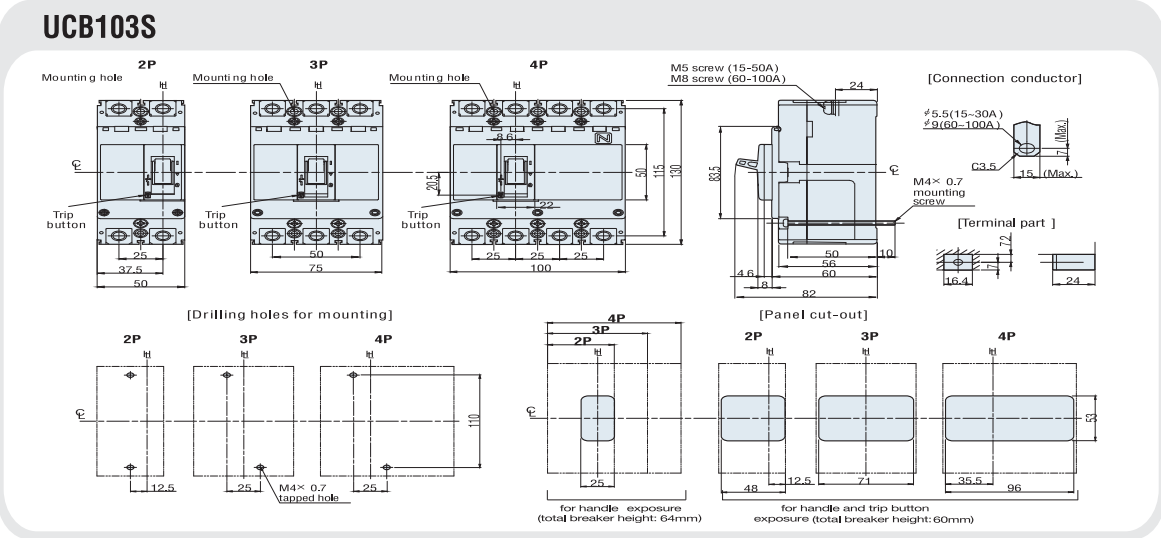

UCB603R/S

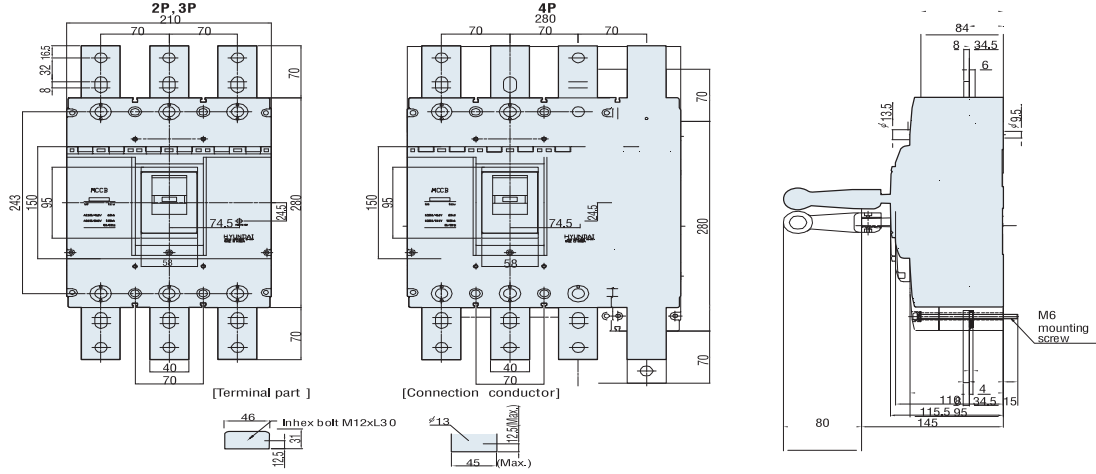

UCB803R/S

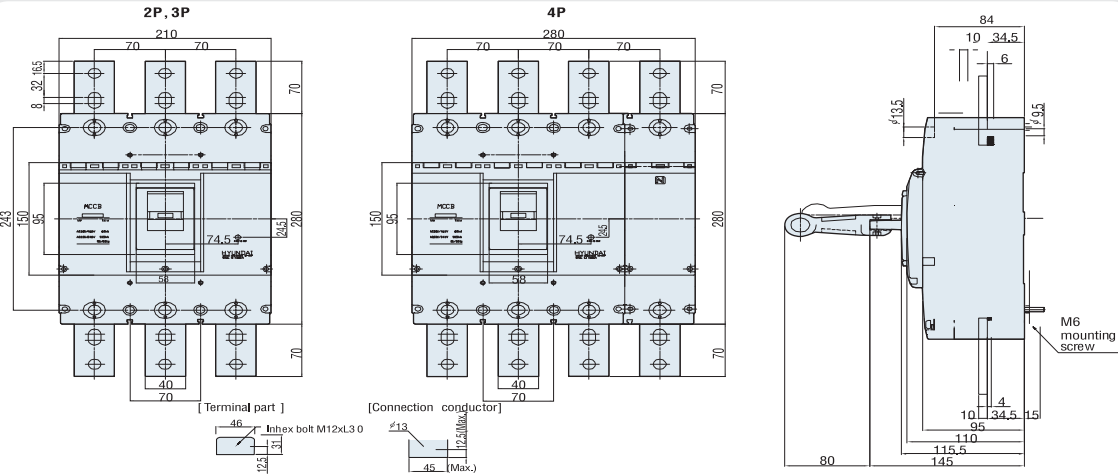

UCB1003S/UCB1253S

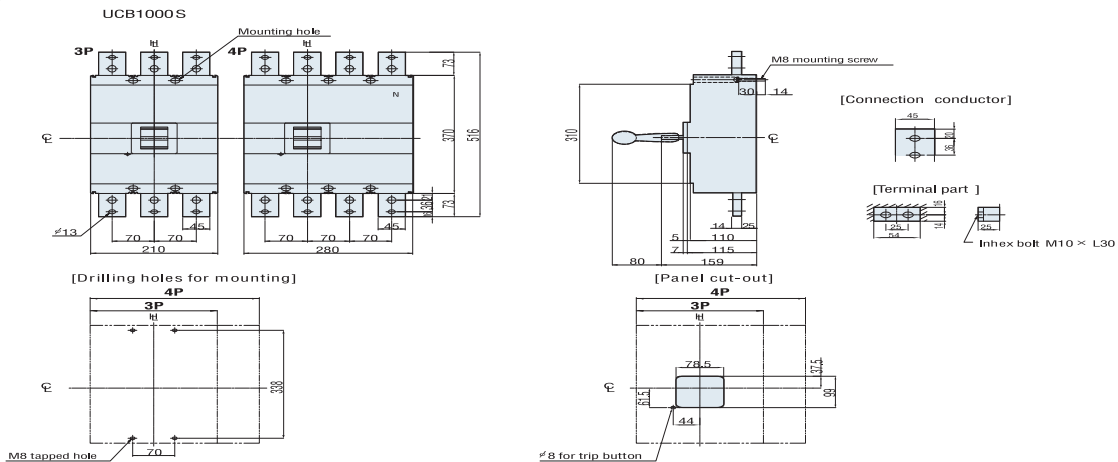

HGM50H/L, 125

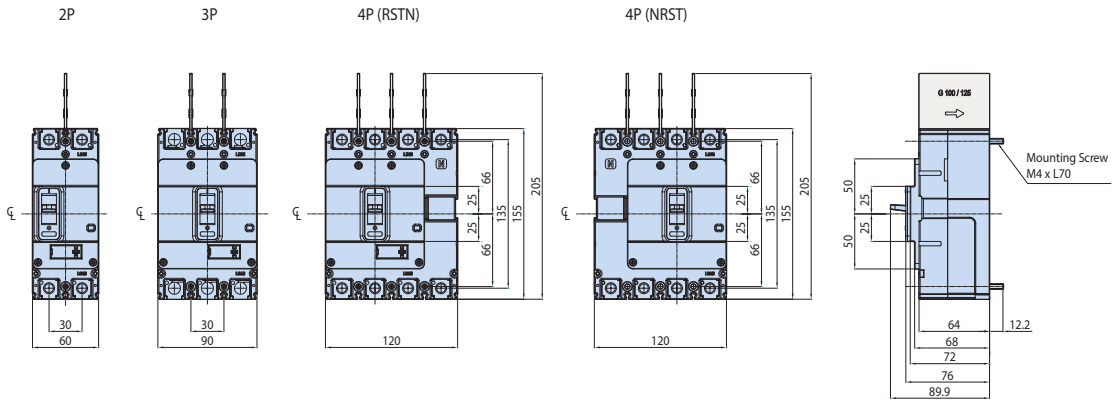

HGM160, 250

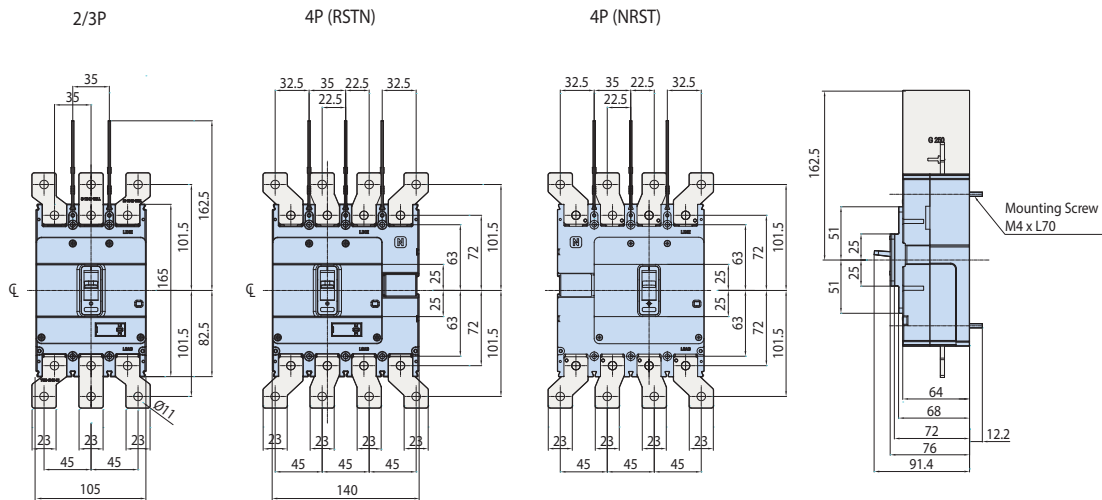

HGM400

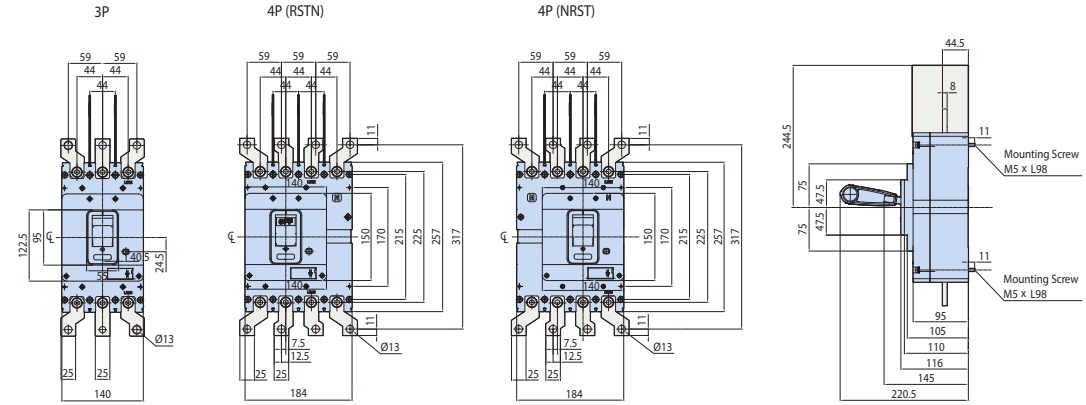

HGM630, 800

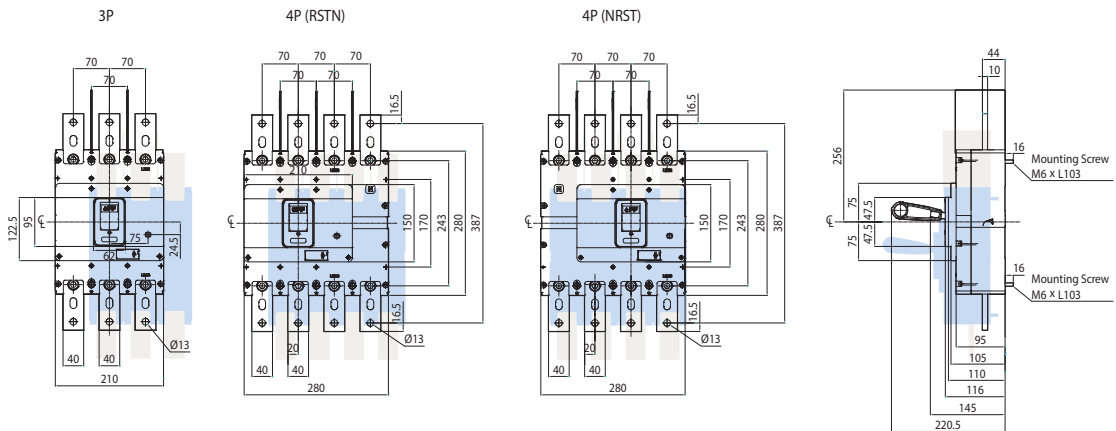



TÜRK STANDARLARI ENSTİTÜSÜ
TÜRK STANDARLARINA UYGUNLUK BELGESİ
TURKISH STANDARDS INSTITUTION
CERTIFICATE OF CONFORMITY TO TURKISH STANDARDS

Markanın Tanıtımı - Description of the Mark
TSE  

BELGE NUMARASI REFERENCE NUMBER OF LICENCE	132791-TSE-0102
BELGENİN İLK VERİŞİŞ TARİHİ DATE OF FIRST ISSUE OF LICENCE	16.04.2015
BELGENİN SON GEÇERLİLİK TARİHİ LICENCE VALID UNTIL	13.10.2020
BELGE SAHİBİ KURULUŞUN ADI NAME OF THE LICENCE HOLDER	HYUNDAI ELECTRIC & ENERGY SYSTEMS CO., LTD.
BELGE SAHİBİ KURULUŞUN ADRESİ ADDRESS OF THE LICENCE HOLDER	75 . YULGOK-RO , JONGNO-GU SEUL -KORE
ÜRETİM YERİ ADI NAME OF THE MANUFACTURING PLACE	HYUNDAI ELECTRIC & ENERGY SYSTEMS CO., LTD.
ÜRETİM YERİ ADRESİ ADDRESS OF THE MANUFACTURING PLACE	1000 BANGGEOJINSUNHWAN-DORO, DONG-GU, ULSAN, KORE Ulsan / KORE
İPTAL EDİLEN BELGE NUMARASI (Varse) INDICATION OF SUPERSEDED LICENCE (if any)	132791-TSE-0101
TESİLLİ TİCARİ MARKASI REGISTERED TRADE MARK	HYUNDAI
İLGİLİ TÜRK STANDARTI RELATED TURKISH STANDARD	TS EN 60947-2 / 06.03.2008

BELGE KAPSAMI
SCOPE OF LICENCE

HGM 30 E/SAHL, HGM 50 E/SAHL,
HGM 60 E/SAHL, HGM 100 E/SAHL

Ue : 220/240/380/415/440/460 Vac
Ui : 1000 Vac,
Uimp : 8kV

e-imzalı/e-signed
28.04.2020

Belgelendirme Merkezi Başkanı Adına
GÜRSEL ERATAK
ELEKTROTEKNİK SEKTÖRÜ MÜDÜRÜ



*Bu belge, belgelendirilen ürünün, sadece belirli standartlara belgelendiği partner kuruluşlar için geçerlidir.
*This certificate is valid only for the products of the licensee, which are certified to the specified standards only.
*TSE BELGELENDİRME MERKEZİ BAŞKANI ADINA: Adres: Nispetiye Cad. No:112 06500 Beşiktaş/İSTANBUL - Telefon: 0 212 418 84 87 Faks: 0 212 418 84 17 E-posta: info@tse.org.tr - web: www.tse.org.tr



<https://tr.vakademi.net.tr/eng/tr/BelgeDetaylari.aspx?YeniBelgeAdi=132791-TSE-0102> 1 / 5



TÜRK STANDARLARI ENSTİTÜSÜ
TÜRK STANDARLARINA UYGUNLUK BELGESİ
TURKISH STANDARDS INSTITUTION
CERTIFICATE OF CONFORMITY TO TURKISH STANDARDS

Markanın Tanıtımı - Description of the Mark
TSE  

BELGE KAPSAMI (132791-TSE-0102)hulu belge devamsı) : HYUNDAI ELECTRIC & ENERGY SYSTEMS CO., LTD.
İLGİLİ TÜRK STANDARTI(RELATED TURKISH STANDARD) : TS EN 60947-2 / 06.03.2008

In	: 15, 16, 20, 25, 30, 32, 40, 50, 60, 63, 75, 80, 100A
Pole	: 2P, 3P, 4P (unprotected N pole)
Rated Frequency	: 50/60 Hz
Icu	:
E Series	: 25 kA at 220/240 V, 16 kA at 380/415/440/460 V
S Series	: 50 kA at 220/240 V, 20 kA at 380/415/440/460 V
H Series	: 50 kA at 220/240 V, 26 kA at 380/415/440/460 V
L Series	: 50 kA at 220/240 V, 30 kA at 380/415/440/460 V
Ics	= 100% Icu for E and S Series
Ics	= 100% Icu at 240 V for H and L Series
Ics	= 75% Icu at 460 V for H Series
Ics	= 50% Icu at 460 V for L Series

HGM 50 H/L, HGM 125 E/SAHL

Ue : 220/240/380/415/440/460 Vac
Ui : 1000 Vac, Uimp : 8kV

In : 15, 16, 20, 25, 30, 32, 40, 50, 60, 63, 75, 80, 100, 125A

Pole : 2P, 3P, 3P+ N(unprotected N pole)

Rated Frequency : 50/60 Hz

Icu :

E Series: 50 kA at 220/240 V, 20 kA at 380/415/440/460 V

e-imzalı/e-signed
28.04.2020

Belgelendirme Merkezi Başkanı Adına
GÜRSEL ERATAK
ELEKTROTEKNİK SEKTÖRÜ MÜDÜRÜ



*Bu belge, belgelendirilen ürünün, sadece belirli standartlara belgelendiği partner kuruluşlar için geçerlidir.
*This certificate is valid only for the products of the licensee, which are certified to the specified standards only.
*TSE BELGELENDİRME MERKEZİ BAŞKANI ADINA: Adres: Nispetiye Cad. No:112 06500 Beşiktaş/İSTANBUL - Telefon: 0 212 418 84 87 Faks: 0 212 418 84 17 E-posta: info@tse.org.tr - web: www.tse.org.tr



<https://tr.vakademi.net.tr/eng/tr/BelgeDetaylari.aspx?YeniBelgeAdi=132791-TSE-0102> 2 / 5



TÜRK STANDARLARI ENSTİTÜSÜ
TÜRK STANDARLARINA UYGUNLUK BELGESİ
TURKISH STANDARDS INSTITUTION
CERTIFICATE OF CONFORMITY TO TURKISH STANDARDS

Markanın Tanıtımı - Description of the Mark
TSE  

BELGE KAPSAMI (132791-TSE-02)hulu belge devamsı) : HYUNDAI ELECTRIC & ENERGY SYSTEMS CO., LTD.
İLGİLİ TÜRK STANDARTI(RELATED TURKISH STANDARD) : TS EN 60947-1-1 / 13.12.2011

HGC 115 + HGT 150K 115	
Rated Current (Ie)	: 115 A
Rated Thermal Current (Ith)	: 180 A
Rated Voltage (Ue)	: AC 220V / 440 V
Rated Insulation Voltage (Ui)	: AC 1000 V
Rated Impulse Withstand Voltage (Uimp)	: 8 kV
Rated Frequency	: 60 Hz
Expanded Short Circuit Current Rating (I) :	10 kA
Conditionally Rated Short Circuit Current (Iq) :	10 kA
Using Class	: AC-3
HGC 130+ HGT 150K 130	
Rated Current (Ie)	: 130 A
Rated Thermal Current (Ith)	: 180 A
Rated Voltage (Ue)	: AC 220V / 440 V
Rated Insulation Voltage (Ui)	: AC 1000 V
Rated Impulse Withstand Voltage (Uimp)	: 8 kV
Rated Frequency	: 60 Hz
Expanded Short Circuit Current Rating (I) :	10 kA
Conditionally Rated Short Circuit Current (Iq) :	10 kA
Using Class	: AC-3
HGC 150+ HGT 150K 150	
Rated Current (Ie)	: 150 A
Rated Thermal Current (Ith)	: 210 A
Rated Voltage (Ue)	: AC 220V / 440 V
Rated Insulation Voltage (Ui)	: AC 1000 V
Rated Impulse Withstand Voltage (Uimp)	: 8 kV
Rated Frequency	: 60 Hz
Expanded Short Circuit Current Rating (I) :	10 kA
Conditionally Rated Short Circuit Current (Iq) :	10 kA
Using Class	: AC-3
HGC 185+ HGT 265K 185	
Rated Current (Ie)	: 185 A
Rated Thermal Current (Ith)	: 275 A

e-imzalı/e-signed
28.04.2020

Belgelendirme Merkezi Başkanı Adına
GÜRSEL ERATAK
ELEKTROTEKNİK SEKTÖRÜ MÜDÜRÜ



*Bu belge, belgelendirilen ürünün, sadece belirli standartlara belgelendiği partner kuruluşlar için geçerlidir.
*This certificate is valid only for the products of the licensee, which are certified to the specified standards only.
*TSE BELGELENDİRME MERKEZİ BAŞKANI ADINA: Adres: Nispetiye Cad. No:112 06500 Beşiktaş/İSTANBUL - Telefon: 0 212 418 84 87 Faks: 0 212 418 84 17 E-posta: info@tse.org.tr - web: www.tse.org.tr



<https://tr.vakademi.net.tr/eng/tr/BelgeDetaylari.aspx?YeniBelgeAdi=132791-TSE-02> 5 / 6



TÜRK STANDARLARI ENSTİTÜSÜ
TÜRK STANDARLARINA UYGUNLUK BELGESİ
TURKISH STANDARDS INSTITUTION
CERTIFICATE OF CONFORMITY TO TURKISH STANDARDS

Markanın Tanıtımı - Description of the Mark
TSE  

BELGE KAPSAMI (132791-TSE-02)hulu belge devamsı) : HYUNDAI ELECTRIC & ENERGY SYSTEMS CO., LTD.
İLGİLİ TÜRK STANDARTI(RELATED TURKISH STANDARD) : TS EN 60947-1-1 / 13.12.2011

HGC 225+ HGT 265K 225	
Rated Voltage (Ue)	: AC 220V / 440 V
Rated Insulation Voltage (Ui)	: AC 1000 V
Rated Impulse Withstand Voltage (Uimp)	: 8 kV
Rated Frequency	: 60 Hz
Expanded Short Circuit Current Rating (I) :	10 kA
Conditionally Rated Short Circuit Current (Iq) :	10 kA
Using Class	: AC-3
HGC 265+ HGT 265K 265	
Rated Current (Ie)	: 225 A
Rated Thermal Current (Ith)	: 315 A
Rated Voltage (Ue)	: AC 220V / 440 V
Rated Insulation Voltage (Ui)	: AC 1000 V
Rated Impulse Withstand Voltage (Uimp)	: 8 kV
Rated Frequency	: 60 Hz
Expanded Short Circuit Current Rating (I) :	10 kA
Conditionally Rated Short Circuit Current (Iq) :	10 kA
Using Class	: AC-3
HGC 265+ HGT 265K 265	
Rated Current (Ie)	: 265 A
Rated Thermal Current (Ith)	: 350 A
Rated Voltage (Ue)	: AC 220V / 440 V
Rated Insulation Voltage (Ui)	: AC 1000 V
Rated Impulse Withstand Voltage (Uimp)	: 8 kV
Rated Frequency	: 60 Hz
Expanded Short Circuit Current Rating (I) :	18 kA
Conditionally Rated Short Circuit Current (Iq) :	18 kA
Using Class	: AC-3

e-imzalı/e-signed
28.04.2020

Belgelendirme Merkezi Başkanı Adına
GÜRSEL ERATAK
ELEKTROTEKNİK SEKTÖRÜ MÜDÜRÜ

*Bu belge, belgelendirilen ürünün, sadece belirli standartlara belgelendiği partner kuruluşlar için geçerlidir.
*This certificate is valid only for the products of the licensee, which are certified to the specified standards only.
*TSE BELGELENDİRME MERKEZİ BAŞKANI ADINA: Adres: Nispetiye Cad. No:112 06500 Beşiktaş/İSTANBUL - Telefon: 0 212 418 84 87 Faks: 0 212 418 84 17 E-posta: info@tse.org.tr - web: www.tse.org.tr



<https://tr.vakademi.net.tr/eng/tr/BelgeDetaylari.aspx?YeniBelgeAdi=132791-TSE-02> 6 / 6



TÜRK STANDARLARI ENSTİTÜSÜ
TÜRK STANDARLARINA UYGUNLUK BELGESİ
TURKISH STANDARDS INSTITUTION
CERTIFICATE OF CONFORMITY TO TURKISH STANDARDS

Markanın Tanıtımı - Description of the Mark
TSE  



BELGE NUMARASI
REFERENCE NUMBER OF LICENCE

BELGENİN İLK VERİŞİŞ TARİHİ
DATE OF FIRST ISSUE OF LICENCE

BELGENİN SON GEÇERLİLİK TARİHİ
LICENCE VALID UNTIL

BELGE SAHİBİ KURULUŞUN ADI
NAME OF THE LICENCE HOLDER

BELGE SAHİBİ KURULUŞUN ADRESİ
ADDRESS OF THE LICENCE HOLDER

ÜRETİM YERİ ADI
NAME OF THE MANUFACTURING PLACE

ÜRETİM YERİ ADRESİ
ADDRESS OF THE MANUFACTURING PLACE

İPTAL EDİLEN BELGE NUMARASI (Varsa)
INDICATION OF SUPERSEDED LICENCE (if any)

TESCİLLİ TİCARİ MARKASI
REGISTERED TRADE MARK

İLGİLİ TÜRK STANDARTI
RELATED TURKISH STANDARD

BELGE KAPSAMI
SCOPE OF LICENCE

Model : HGDKSP, HGDKSS, HGDKSM, HGDKSE
 Anma Gerilimi (Ue) : 240/415 Vac (1P, 1P+N); 415 Vac (3P,3P+N,4P)
 Anma Akımı (In) : 1, 2, 3, 4, 5, 6, 10, 13, 15, 16, 20, 25, 32, 40, 50, 63A
 Kutup Sayısı (Pole) : 1P, 1P+N, 2P,3P,3P+N,4P - B.C.D type
 Kısa Devre Kap. (Icn) : 3000, 4500, 6000, 10000 A
 Servis Devre Kap. (Ics) : 3000, 4500, 6000, 7500 A

e-izale/e-signed
26.02.2020
Belgelendirme Merkezi Başkanı Adına
GÜRSEL ERATAK
ELEKTROTEKNİK SEKTÖRÜ MÜDÜRÜ

"Bu belge, belgelendirilen ürünün, belirli periyotlarla Enstitü tarafından belirlenen şartlar kapsamında değerlendirilmiştir." / "This certificate is issued on condition that the product will be periodically re-evaluated by the Institution within the scope of the licence."/>

TSE BELGELENDİRME MERKEZİ BAŞKANI ADINA: Necdetiye Çelebi No:112 06100 Sakarya/BURSA/ANKARA - Telefon: 0212 415 84 87 Faks: 0212 415 84 17 E-posta: info@tse.org.tr - web: www.tse.org.tr

<http://tr.vakademi.net.tr/eng/tr/BelgeDetaylari.aspx?yayinId=6764>



1 / 2



TÜRK STANDARLARI ENSTİTÜSÜ
TÜRK STANDARLARINA UYGUNLUK BELGESİ
TURKISH STANDARDS INSTITUTION
CERTIFICATE OF CONFORMITY TO TURKISH STANDARDS

Markanın Tanıtımı - Description of the Mark
TSE  



BELGE KAPSAMI (132791-TSE-03/03nolu belge devamı) : HYUNDAI ELECTRIC & ENERGY SYSTEMS CO., LTD.
İLGİLİ TÜRK STANDARTI(RELATED TURKISH STANDARD) : TS 5018-1 EN 60898-1 / 27.09.2005 - TS 5018-1 EN 60898-1/IA12 / 08.11.2010 - TS EN 60898-1/IA13 / 12.06.2013 - TS 5018-1 EN 60898-1/IA11 / 09.03.2006

Energy limiting class : 3

e-izale/e-signed
26.02.2020
Belgelendirme Merkezi Başkanı Adına
GÜRSEL ERATAK
ELEKTROTEKNİK SEKTÖRÜ MÜDÜRÜ

"Bu belge, belgelendirilen ürünün, belirli periyotlarla Enstitü tarafından belirlenen şartlar kapsamında değerlendirilmiştir." / "This certificate is issued on condition that the product will be periodically re-evaluated by the Institution within the scope of the licence."/>

TSE BELGELENDİRME MERKEZİ BAŞKANI ADINA: Necdetiye Çelebi No:112 06100 Sakarya/BURSA/ANKARA - Telefon: 0212 415 84 87 Faks: 0212 415 84 17 E-posta: info@tse.org.tr - web: www.tse.org.tr

<http://tr.vakademi.net.tr/eng/tr/BelgeDetaylari.aspx?yayinId=6764>



2 / 2



TÜRK STANDARLARI ENSTİTÜSÜ
TÜRK STANDARLARINA UYGUNLUK BELGESİ
TURKISH STANDARDS INSTITUTION
CERTIFICATE OF CONFORMITY TO TURKISH STANDARDS

Markanın Tanıtımı - Description of the Mark
TSE  



BELGE NUMARASI
REFERENCE NUMBER OF LICENCE

BELGENİN İLK VERİŞİŞ TARİHİ
DATE OF FIRST ISSUE OF LICENCE

BELGENİN SON GEÇERLİLİK TARİHİ
LICENCE VALID UNTIL

BELGE SAHİBİ KURULUŞUN ADI
NAME OF THE LICENCE HOLDER

BELGE SAHİBİ KURULUŞUN ADRESİ
ADDRESS OF THE LICENCE HOLDER

ÜRETİM YERİ ADI
NAME OF THE MANUFACTURING PLACE

ÜRETİM YERİ ADRESİ
ADDRESS OF THE MANUFACTURING PLACE

İPTAL EDİLEN BELGE NUMARASI (Varsa)
INDICATION OF SUPERSEDED LICENCE (if any)

TESCİLLİ TİCARİ MARKASI
REGISTERED TRADE MARK

İLGİLİ TÜRK STANDARTI
RELATED TURKISH STANDARD

BELGE KAPSAMI
SCOPE OF LICENCE

Model : HRCSS3 & HRC100S
 Anma Gerilimi (Ue) : 240 Vac (2P), 415 Vac (4P)
 Anma Akımı (In) : 16, 25, 32, 40, 50, 63, 80, 100A
 Kutup Sayısı (Pole) : 2P, 4P
 Tip : A, AC
 Çalışma Sıcaklığı : -25 - +40 C

e-izale/e-signed
26.02.2020
Belgelendirme Merkezi Başkanı Adına
GÜRSEL ERATAK
ELEKTROTEKNİK SEKTÖRÜ MÜDÜRÜ

"Bu belge, belgelendirilen ürünün, belirli periyotlarla Enstitü tarafından belirlenen şartlar kapsamında değerlendirilmiştir." / "This certificate is issued on condition that the product will be periodically re-evaluated by the Institution within the scope of the licence."/>

TSE BELGELENDİRME MERKEZİ BAŞKANI ADINA: Necdetiye Çelebi No:112 06100 Sakarya/BURSA/ANKARA - Telefon: 0212 415 84 87 Faks: 0212 415 84 17 E-posta: info@tse.org.tr - web: www.tse.org.tr

<http://tr.vakademi.net.tr/eng/tr/BelgeDetaylari.aspx?yayinId=6764>



1 / 2



TÜRK STANDARLARI ENSTİTÜSÜ
TÜRK STANDARLARINA UYGUNLUK BELGESİ
TURKISH STANDARDS INSTITUTION
CERTIFICATE OF CONFORMITY TO TURKISH STANDARDS

Markanın Tanıtımı - Description of the Mark
TSE  



BELGE KAPSAMI (132791-TSE-04/03nolu belge devamı) : HYUNDAI ELECTRIC & ENERGY SYSTEMS CO., LTD.
İLGİLİ TÜRK STANDARTI(RELATED TURKISH STANDARD) : TS EN 61008-1 / 12.06.2013

Çalışma Fonksiyonu : Hat Geriliminden Bağımsız
 Anma Arlık Akımları (In) : 30,100,300 mA(A-type);

e-izale/e-signed
26.02.2020
Belgelendirme Merkezi Başkanı Adına
GÜRSEL ERATAK
ELEKTROTEKNİK SEKTÖRÜ MÜDÜRÜ

"Bu belge, belgelendirilen ürünün, belirli periyotlarla Enstitü tarafından belirlenen şartlar kapsamında değerlendirilmiştir." / "This certificate is issued on condition that the product will be periodically re-evaluated by the Institution within the scope of the licence."/>

TSE BELGELENDİRME MERKEZİ BAŞKANI ADINA: Necdetiye Çelebi No:112 06100 Sakarya/BURSA/ANKARA - Telefon: 0212 415 84 87 Faks: 0212 415 84 17 E-posta: info@tse.org.tr - web: www.tse.org.tr

<http://tr.vakademi.net.tr/eng/tr/BelgeDetaylari.aspx?yayinId=6764>



2 / 2

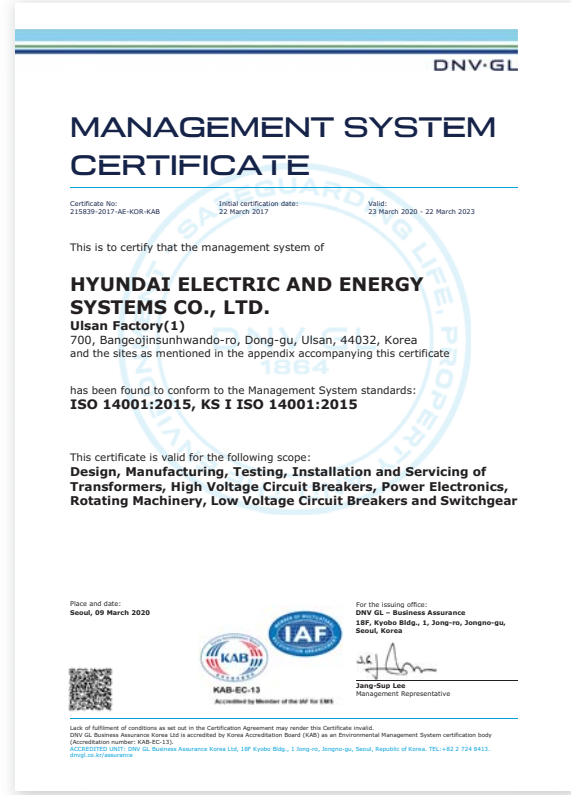

- Fiyatlarımızda herhangi bir ihbara gerek duyulmaksızın değişiklik yapma hakkımız mahfuzdur.
- Faturalamada teslim tarihindeki liste fiyatları geçerlidir.
- Fiyatlarımıza KDV dahil değildir.
- Listemizde bulunmayan ürünlerimiz için lütfen Yetkili Bayilerimiz veya Bölge Müdürlüklerimizle temasa geçiniz.
- Diğer bütün sertifikalar ve belgeler için lütfen Yetkili Bayilerimiz veya Bölge Müdürlüklerimizle temasa geçiniz.



Global Leader

Building a better future



YETKİLİ BAYİ



MERKEZ: Mahmutbey Mah. Halkalı Cad. 2627 Sk.
No: 8 Mahmutbey 34218 Bağcılar / İSTANBUL
☎ 0212 651 23 47 pbx ☎ 0212 651 23 45

ŞUBE: Perpa Ticaret Merkezi A Blok Kat: 13
No: 1976 Okmeydanı 34384 Şişli / İSTANBUL
☎ 0212 320 81 85 pbx ☎ 0212 320 85 57

✉ info@ruhaelektrik.com

👉 www.ruhaelektrik.com

SATIŞ PAZARLAMA

Halil Rifat Paşa Mh. Yüzer Havuz Sk. Perpa Ticaret Merkezi
A Blok Kat. 2 No: 9/0042 Okmeydanı 34384 Şişli / İSTANBUL
☎ 0212 221 11 40-43 ☎ 0555 968 11 27

✉ info@hyundai-electric.com.tr

👉 www.hyundai-electric.com.tr