

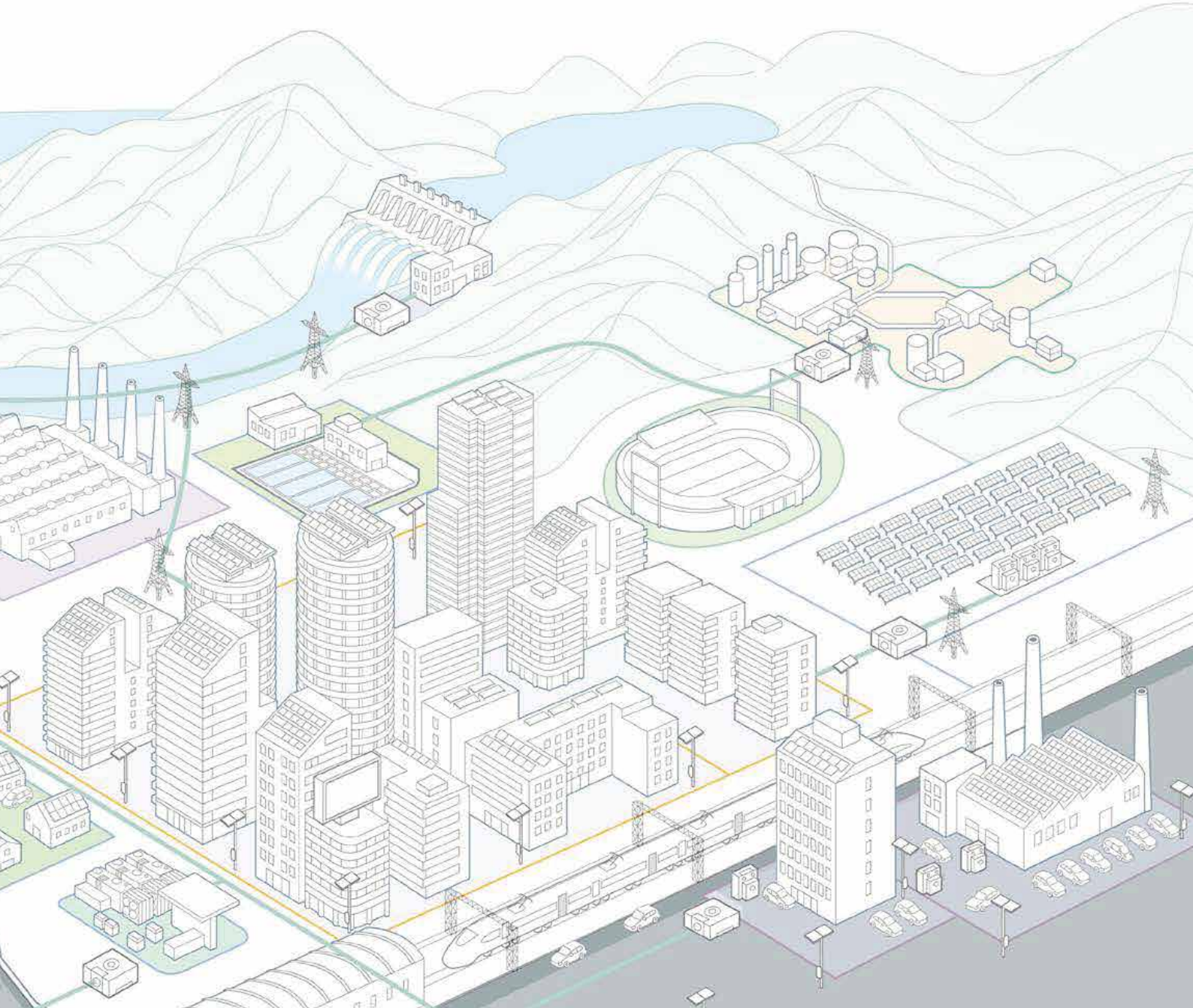

A.G. Dağıtım Ekipmanları

Fiyat Listesi

Mart 2024



LS Grup, Elektrik Dağıtım, Endüstriyel Otomasyon, Makine ve Enerji konularında faaliyet gösteren Merkezi Güney Kore'de bulunan bir Holdingdir. Büyüyen iş hacmi neticesinde, müşterilerine daha iyi hizmet sunabilmek için 2003 yılında LG grup'tan ayrılarak bağımsız bir yapıya bürünmüştür.



İçindekiler

Otomatik Sigortalar	06	Kompakt Tip Şalterler	30
Kaçak Akım Koruma Şalterleri	12	Metasol Serisi	32
Sessiz Kontaktörler & Darbe Akım Anahtarları	14	Susol Serisi	38
Manyetik Güç Kontaktörleri	16	Açık Tip Şalterler	50
Mini Kontaktörler	24	Metasol Serisi	52
Motor Koruma Şalterleri	26	Susol Kompakt Serisi	58

ÜRÜN AİLESİ LS Elektrik enerjinin yeni çağında akıllı güç ve otomasyon

EMS
Energy Management System

SCADA
Supervisory Control And Data Acquisition

DMS
Distribution Management System

DCS
Distribution Control System

Akıllı Güç Çözümleri

Sistemler

Güneş Enerji Sistemleri



Enerji Depolama Sistemleri (ESS)



Raylı Sistemler



Yüksek Gerilim DC Sistemleri (HVDC)



Esnek AC İletim Sistemleri (FACTS)



Modüler Dağıtım İstasyonları



Gaz İzoleli Şalt Sistemleri (GIS)



Trafoalar



Panolar / Busbar



YG Pano Sistemleri



AG Pano Sistemleri



RMU



Yıldırım Koruma Sistemleri



Busbar

Koruma / Ölçüm / Gösterge

Koruma



GIPAM 115

GIPAM 3000

X-GIPAM

Ölçüm



GIMAC 1000
(New GIMAC-i)

GIMAC-II Plus

GIMAC-V

GIMAC-B

Gösterge



Motor Koruma Röleleri (EMPR)



GMP

DMPI

IMP

MMP

Data Toplama Cihazları



Cloud Service

Operation Service

Gateway

M LINK

E TAG

Ürünler

sistemlerinde toplam çözümler sunar

x EMS FEMS BEMS HEMS

Microgrid

GridSol CARE

TECH SQU

Akıllı Güç Çözümleri

Alçak Gerilim

Parafudr (SPD)



Din Tipi

Kufulu Tipi

Otomatik Sigortalar/ Kaçak Akım Koruma Şalterleri



MCB

CP

Kontaktör / Termik Röleler



Metasol Contactor

Soft Starter

Kompakt Tip Şalterler (MCCB/ELCB)



Metasol MCCB/ELCB

Susol MCCB

Susol MCCB (New PI)

RCD

Açık Tip Şalterler (ACB)



Metasol ACB

Susol ACB

Susol Compact ACB

Susol ACB (New PI)

DC Dağıtım Ekipmanları

DC



Orta Gerilim

Vakum Kesciciler (VCB)



Susol VCB

Vakum Kontaktörler



Susol VCB

HV Ayırıcılar



LBS/ASS



Power Fuse



ALTS



GLBS/SLBS

Akıllı Otomasyon Çözümleri

Akıllı Fabrikalar

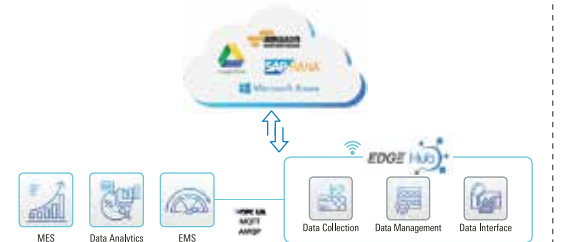

SCADA



HMI



PLC



Sürücüler



AG Sürücüler

YG Sürücüler

Servo Sistemler



Redüktörler



EK60 LV MDB

Alçak Gerilim Modüler Pano Sistemleri



intertek
The Quality Standard

ASTA TYPE CERTIFICATE VERIFICATION OF TEST

Project No: G10495009TR1 **Certificate No:** ASTA-TYPE-0001772

Applicant: LS ELECTRIC CO., LTD.
60, Walseong-ro, 203 Seonggu, Hwangbuk-gu, Cheongju-si,
Chungcheongbuk-do, Korea 28199

Apparatus: 33kVA, three-phase, 400V/2000VA (400V/230V), 300A, Power Transformer and
Controlgear assembly incorporating a three-phase and neutral horizontal and vertical bus
system, busbar system with one outgoing ACB unit, two outgoing ACB units, seven
outgoing MCCB units and a protection device.

Manufactured By: LS ELECTRIC CO., LTD.
60, Walseong-ro, 203 Seonggu, Hwangbuk-gu, Cheongju-si,
Chungcheongbuk-do, Korea 28199

Test Report No: 211901-RL-122-037

Designation: 1000-0300A, 1000A LV Switchgear

The certificate which is representative of the designation, supplied drawings and photographs has been
evaluated in accordance with:

IEC 61439-1, Edition 3.0 2020-05

Verifications with reference to the tests listed in Annex C of IEC 61439-1, Edition 3.0 2020-05	Acceptance of switching devices and components
1: Strength of terminal and parts (cl. 10.2.3.1.1)	7: Internal electrical contacts and connections
2: Degree of protection of enclosures	8: Resistance to external conductors
3: Clearance	9: Dielectric properties
4: Creepage distances	10: Temperature rise
5: Frequency of protective devices	11: Short-circuit withstand strength

The results are shown in the record of tests attached hereto. The values obtained and the general performance is
considered to comply with the above standards and to justify the ratings assigned by the manufacturer.
This certificate applies only to the apparatus listed.
Responsibility for conformity of any apparatus having the same or other designations rests with the
Manufacturer.





 23rd December 2022
 Date
 C Doak Evans
 Certification Engineer
 Certification Officer

0010
 2022/12/23
 1000-0300A, 1000A LV Switchgear

SUSOL EK60LV MDB

EK60LV MDB Modüler Tip Pano sistemleri yüksek kaliteli enerji dağıtım panolarının imalatı için tasarlandı. Yüksek performans ve kaliteli yapısı ile endüstrinin her alanında kullanılmaya elverişlidir.

Kolay tasarım, imalat ve bakım avantajları ile IEC61439-1&2 standartlarına uygun yapıdadır.

Yüksek Performans ve Güvenilirlik

IP 54

6300 A, 690 VAC, 100 kA test dayanımı

IEC61439-1 & 2 normlarına uygun ASTA sertifikası



Uygulamalar

İmalat Endüstrisi ve Ağır Sanayi
İçme Suyu ve Atıksu Arıtma Tesisleri
Hastane, Otel, Tatil Köyleri ve Alışveriş Merkezleri
Raylı Sistemler ve Havaalanları
Ticari Binalar, Nitelikli Yaşam Alanları Konutlar
Veri Merkezleri

Teknik Veriler





Açıklama	EK60LV
Güç Devresi	1000 VAC, 3 Faz, 50/60 Hz
Kontrol Devresi	440VA / 220VDC
Anma Akımı	6300 A
Kısa Devre Akım Dayanımı	100 kA, 1 Saniye (IEC 61439)
Sıcaklık Artışı	IEC61439
Ortam Sıcaklığı	-5 / 50 °C
Korun Sınıfı	IP54
Boya Rengi	RAL 7035
Pano Boyutları	Yükseklik Maksimum 2150mm + 100 mm'e kadar farklı yüksekliklerde Genişlik 1200mm'e kadar farklı yüksekliklerde Derinlik 1200mm'e kadar farklı yüksekliklerde

Otomatik Sigortalar ve Kaçak Akım Koruma Şalterleri



BKJ63N Serisi





B Eğrisi, 6 kA, 230-400 VAC

	In	Model	Sipariş Kodu	Kutu Adedi	Liste Fiyatı (\$)
BKJ63N 1P 	1A	BKJ63N 1P B1	06112360	12	5,95
	2A	BKJ63N 1P B2	06112361	12	5,95
	3A	BKJ63N 1P B3	06112362	12	5,95
	4A	BKJ63N 1P B4	06112363	12	5,95
	6A	BKJ63N 1P B6	06112364	12	5,69
	10A	BKJ63N 1P B10	06112365	12	5,69
	16A	BKJ63N 1P B16	06112367	12	5,69
	20A	BKJ63N 1P B20	06112368	12	5,69
	25A	BKJ63N 1P B25	06112369	12	5,69
	32A	BKJ63N 1P B32	06112370	12	5,69
	40A	BKJ63N 1P B40	06112371	12	6,66
	50A	BKJ63N 1P B50	06112372	12	6,66
	63A	BKJ63N 1P B63	06112373	12	6,66
	BKJ63N 2P 	1A	BKJ63N 2P B1	06122633	6
2A		BKJ63N 2P B2	06122634	6	13,26
3A		BKJ63N 2P B3	06122635	6	13,26
4A		BKJ63N 2P B4	06122636	6	13,26
6A		BKJ63N 2P B6	06122637	6	12,94
10A		BKJ63N 2P B10	06122638	6	12,94
16A		BKJ63N 2P B16	06122640	6	12,94
20A		BKJ63N 2P B20	06122641	6	12,94
25A		BKJ63N 2P B25	06122642	6	12,94
32A		BKJ63N 2P B32	06122643	6	12,94
40A		BKJ63N 2P B40	06122644	6	13,59
50A		BKJ63N 2P B50	06122645	6	13,59
63A		BKJ63N 2P B63	06122646	6	13,59
BKJ63N 3P 		1A	BKJ63N 3P B1	06131171	4
	2A	BKJ63N 3P B2	06131172	4	20,90
	3A	BKJ63N 3P B3	06131173	4	20,90
	4A	BKJ63N 3P B4	06131174	4	20,90
	6A	BKJ63N 3P B6	06131175	4	19,98
	10A	BKJ63N 3P B10	06131176	4	19,98
	16A	BKJ63N 3P B16	06131178	4	19,98
	20A	BKJ63N 3P B20	06131179	4	19,98
	25A	BKJ63N 3P B25	06131180	4	19,98
	32A	BKJ63N 3P B32	06131181	4	19,98
	40A	BKJ63N 3P B40	06131182	4	21,22
	50A	BKJ63N 3P B50	06131183	4	21,22
	63A	BKJ63N 3P B63	06131184	4	21,22
	BKJ63N 4P 	1A	BKJ63N 4P B1	06141994	3
2A		BKJ63N 4P B2	06141995	3	27,24
3A		BKJ63N 4P B3	06141996	3	27,24
4A		BKJ63N 4P B4	06141997	3	27,24
6A		BKJ63N 4P B6	06141998	3	26,25
10A		BKJ63N 4P B10	06141999	3	26,25
16A		BKJ63N 4P B16	06142001	3	26,25
20A		BKJ63N 4P B20	06142002	3	26,25
25A		BKJ63N 4P B25	06142003	3	26,25
32A		BKJ63N 4P B32	06142004	3	26,25
40A		BKJ63N 4P B40	06142005	3	31,94
50A		BKJ63N 4P B50	06142006	3	31,94
63A		BKJ63N 4P B63	06142007	3	31,94

Otomatik Sigortalar

BKJ63N Serisi

C Eğrisi, 6 kA, 230-400 VAC

	In	Model	Sipariş Kodu	Kutu Adedi	Liste Fiyatı (\$)
BKJ63N 1P 	1A	BKJ63N 1P C1	06112374	12	5,95
	2A	BKJ63N 1P C2	06112375	12	5,95
	3A	BKJ63N 1P C3	06112376	12	5,95
	4A	BKJ63N 1P C4	06112377	12	5,95
	6A	BKJ63N 1P C6	06112378	12	5,69
	10A	BKJ63N 1P C10	06112379	12	5,69
	16A	BKJ63N 1P C16	06112381	12	5,69
	20A	BKJ63N 1P C20	06112382	12	5,69
	25A	BKJ63N 1P C25	06112383	12	5,69
	32A	BKJ63N 1P C32	06112384	12	5,69
	40A	BKJ63N 1P C40	06112385	12	6,66
	50A	BKJ63N 1P C50	06112386	12	6,66
	63A	BKJ63N 1P C63	06112387	12	6,66
	BKJ63N 2P 	1A	BKJ63N 2P C1	06122647	6
2A		BKJ63N 2P C2	06122648	6	13,26
3A		BKJ63N 2P C3	06122649	6	13,26
4A		BKJ63N 2P C4	06122650	6	13,26
6A		BKJ63N 2P C6	06122651	6	12,94
10A		BKJ63N 2P C10	06122652	6	12,94
16A		BKJ63N 2P C16	06122654	6	12,94
20A		BKJ63N 2P C20	06122655	6	12,94
25A		BKJ63N 2P C25	06122656	6	12,94
32A		BKJ63N 2P C32	06122657	6	12,94
40A		BKJ63N 2P C40	06122658	6	13,59
50A		BKJ63N 2P C50	06122659	6	13,59
63A		BKJ63N 2P C63	06122660	6	13,59
BKJ63N 3P 		1A	BKJ63N 3P C1	06131185	4
	2A	BKJ63N 3P C2	06131186	4	20,90
	3A	BKJ63N 3P C3	06131187	4	20,90
	4A	BKJ63N 3P C4	06131188	4	20,90
	6A	BKJ63N 3P C6	06131189	4	19,98
	10A	BKJ63N 3P C10	06131190	4	19,98
	16A	BKJ63N 3P C16	06131192	4	19,98
	20A	BKJ63N 3P C20	06131193	4	19,98
	25A	BKJ63N 3P C25	06131194	4	19,98
	32A	BKJ63N 3P C32	06131195	4	19,98
	40A	BKJ63N 3P C40	06131196	4	21,22
	50A	BKJ63N 3P C50	06131197	4	21,22
	63A	BKJ63N 3P C63	06131198	4	21,22
	BKJ63N 4P 	1A	BKJ63N 4P C1	06142008	3
2A		BKJ63N 4P C2	06142009	3	27,24
3A		BKJ63N 4P C3	06142010	3	27,24
4A		BKJ63N 4P C4	06142011	3	27,24
6A		BKJ63N 4P C6	06142012	3	26,25
10A		BKJ63N 4P C10	06142013	3	26,25
16A		BKJ63N 4P C16	06142015	3	26,25
20A		BKJ63N 4P C20	06142016	3	26,25
25A		BKJ63N 4P C25	06142017	3	26,25
32A		BKJ63N 4P C32	06142018	3	26,25
40A		BKJ63N 4P C40	06142019	3	31,94
50A		BKJ63N 4P C50	06142020	3	31,94
63A		BKJ63N 4P C63	06142021	3	31,94

B Eğrisi, 10 kA, 240-415 VAC

BKN-b 1P



BKN-b 2P



BKN-b 3P



BKN-b 4P







In	Model	Sipariş Kodu	Kutu Adedi	Liste Fiyatı (\$)
1A	BKN-b 1P B1	06111258	12	10,17
2A	BKN-b 1P B2	06111259	12	10,17
3A	BKN-b 1P B3	06111260	12	10,17
4A	BKN-b 1P B4	06111261	12	10,17
6A	BKN-b 1P B6	06111262	12	9,21
10A	BKN-b 1P B10	06111263	12	9,21
16A	BKN-b 1P B16	06111264	12	9,21
20A	BKN-b 1P B20	06111265	12	9,21
25A	BKN-b 1P B25	06111266	12	9,21
32A	BKN-b 1P B32	06111267	12	9,21
40A	BKN-b 1P B40	06111268	12	10,83
50A	BKN-b 1P B50	06111269	12	10,83
63A	BKN-b 1P B63	06111270	12	10,83
1A	BKN-b 2P B1	06121646	6	21,77
2A	BKN-b 2P B2	06121647	6	21,77
3A	BKN-b 2P B3	06121648	6	21,77
4A	BKN-b 2P B4	06121649	6	21,77
6A	BKN-b 2P B6	06121650	6	20,90
10A	BKN-b 2P B10	06121651	6	20,90
16A	BKN-b 2P B16	06121652	6	20,90
20A	BKN-b 2P B20	06121653	6	20,90
25A	BKN-b 2P B25	06121654	6	20,90
32A	BKN-b 2P B32	06121655	6	20,90
40A	BKN-b 2P B40	06121656	6	22,79
50A	BKN-b 2P B50	06121657	6	22,79
63A	BKN-b 2P B63	06121658	6	22,79
1A	BKN-b 3P B1	06130735	4	37,30
2A	BKN-b 3P B2	06130736	4	37,30
3A	BKN-b 3P B3	06130737	4	37,30
4A	BKN-b 3P B4	06130738	4	37,30
6A	BKN-b 3P B6	06130739	4	32,20
10A	BKN-b 3P B10	06130740	4	32,20
16A	BKN-b 3P B16	06130741	4	32,20
20A	BKN-b 3P B20	06130742	4	32,20
25A	BKN-b 3P B25	06130743	4	32,20
32A	BKN-b 3P B32	06130744	4	32,20
40A	BKN-b 3P B40	06130745	4	37,95
50A	BKN-b 3P B50	06130746	4	37,95
63A	BKN-b 3P B63	06130747	4	37,95
1A	BKN-b 4P B1	06141389	3	50,94
2A	BKN-b 4P B2	06141390	3	50,94
3A	BKN-b 4P B3	06141391	3	50,94
4A	BKN-b 4P B4	06141392	3	50,94
6A	BKN-b 4P B6	06141393	3	49,32
10A	BKN-b 4P B10	06141394	3	49,32
16A	BKN-b 4P B16	06141395	3	49,32
20A	BKN-b 4P B20	06141396	3	49,32
25A	BKN-b 4P B25	06141397	3	49,32
32A	BKN-b 4P B32	06141398	3	49,32
40A	BKN-b 4P B40	06141399	3	53,76
50A	BKN-b 4P B50	06141400	3	53,76
63A	BKN-b 4P B63	06141401	3	53,76

Otomatik Sigortalar

BKN-b Serisi

C Eğrisi, 10 kA, 240-415 VAC

	In	Model	Sipariş Kodu	Kutu Adedi	Liste Fiyatı (\$)	
BKN-b 1P 	1A	BKN-b 1P C1	06111271	12	10,17	
	2A	BKN-b 1P C2	06111272	12	10,17	
	3A	BKN-b 1P C3	06111273	12	10,17	
	4A	BKN-b 1P C4	06111274	12	10,17	
	6A	BKN-b 1P C6	06111275	12	9,21	
	10A	BKN-b 1P C10	06111276	12	9,21	
	16A	BKN-b 1P C16	06111277	12	9,21	
	20A	BKN-b 1P C20	06111278	12	9,21	
	25A	BKN-b 1P C25	06111279	12	9,21	
	32A	BKN-b 1P C32	06111280	12	9,21	
	40A	BKN-b 1P C40	06111281	12	10,83	
	50A	BKN-b 1P C50	06111282	12	10,83	
	63A	BKN-b 1P C63	06111283	12	10,83	
	BKN-b 2P 	1A	BKN-b 2P C1	06121594	6	21,77
		2A	BKN-b 2P C2	06121595	6	21,77
3A		BKN-b 2P C3	06121596	6	21,77	
4A		BKN-b 2P C4	06121597	6	21,77	
6A		BKN-b 2P C6	06121598	6	20,90	
10A		BKN-b 2P C10	06121599	6	20,90	
16A		BKN-b 2P C16	06121600	6	20,90	
20A		BKN-b 2P C20	06121601	6	20,90	
25A		BKN-b 2P C25	06121602	6	20,90	
32A		BKN-b 2P C32	06121603	6	20,90	
40A		BKN-b 2P C40	06121604	6	22,79	
50A		BKN-b 2P C50	06121605	6	22,79	
63A		BKN-b 2P C63	06121606	6	22,79	
BKN-b 3P 		1A	BKN-b 3P C1	06130709	4	37,30
		2A	BKN-b 3P C2	06130710	4	37,30
	3A	BKN-b 3P C3	06130711	4	37,30	
	4A	BKN-b 3P C4	06130712	4	37,30	
	6A	BKN-b 3P C6	06130713	4	32,20	
	10A	BKN-b 3P C10	06130714	4	32,20	
	16A	BKN-b 3P C16	06130715	4	32,20	
	20A	BKN-b 3P C20	06130716	4	32,20	
	25A	BKN-b 3P C25	06130717	4	32,20	
	32A	BKN-b 3P C32	06130718	4	32,20	
	40A	BKN-b 3P C40	06130719	4	37,95	
	50A	BKN-b 3P C50	06130720	4	37,95	
	63A	BKN-b 3P C63	06130721	4	37,95	
	BKN-b 4P 	1A	BKN-b 4P C1	06141337	3	50,94
		2A	BKN-b 4P C2	06141338	3	50,94
3A		BKN-b 4P C3	06141339	3	50,94	
4A		BKN-b 4P C4	06141340	3	50,94	
6A		BKN-b 4P C6	06141341	3	49,32	
10A		BKN-b 4P C10	06141342	3	49,32	
16A		BKN-b 4P C16	06141343	3	49,32	
20A		BKN-b 4P C20	06141344	3	49,32	
25A		BKN-b 4P C25	06141345	3	49,32	
32A		BKN-b 4P C32	06141346	3	49,32	
40A		BKN-b 4P C40	06141347	3	53,76	
50A		BKN-b 4P C50	06141348	3	53,76	
63A		BKN-b 4P C63	06141349	3	53,76	

BKJ63N + BKN-b Serisi Yardımcı Donanımlar

	Model		Sipariş Kodu	Açıklama	Liste Fiyatı (\$)
	AX	Yardımcı Kontak	06150012R0	BKN-b / BKJ63N AX 6A	17,70
	AL	Alarm Kontak	06150013R0	BKN-b / BKJ63N AL 6A Alarm	17,70
	SHT	Açtırma Bobini	06150082R0	BKN-b / BKJ63N SHUNT AC 110/415V (Açtırma Bobini)	27,12
	UVT/OVT	Yüksek/Düşük Gerilim Bobini	06150083R0	BKN-b / BKJ63N OVT/UVT (Yüksek/Düşük Gerilim Bobini)	55,63
	BBN101	Busbar	70211413001	BUSBAR, BB101, BKN 1P, 12 Modül (12 köprüleme)	16,40
	BBN201	Busbar	70211413003	BUSBAR, BB201, BKN 2P, 12 Modül (6 köprüleme)	29,13
	BBN301	Busbar	70211413005	BUSBAR, BB301, BKN 3P, 12 Modül (4 köprüleme)	46,50
	BBN401	Busbar	70211413007	BUSBAR, BB401, BKN 4P, 12 Modül (3 köprüleme)	61,06

C Eğrisi, 10 kA, 230-400 VAC





BKH Serisi







Kutup	In	Model	Sipariş Kodu	Kutu Adedi	Liste Fiyatı (\$)
1P	63A	BKH 1P C63	06111250	12	20,25
	80A	BKH 1P C80	06111251	12	20,25
	100A	BKH 1P C100	06111252	12	20,25
	125A	BKH 1P C125	06111253	12	39,48
2P	63A	BKH 2P C63	06121573	6	41,54
	80A	BKH 2P C80	06121574	6	41,54
	100A	BKH 2P C100	06121575	6	41,54
	125A	BKH 2P C125	06121576	6	49,04
3P	63A	BKH 3P C63	06130701	4	64,81
	80A	BKH 3P C80	06130702	4	64,81
	100A	BKH 3P C100	06130703	4	64,81
	125A	BKH 3P C125	06130704	4	75,83
4P	63A	BKH 4P C63	06141312	3	85,06
	80A	BKH 4P C80	06141313	3	85,06
	100A	BKH 4P C100	06141314	3	85,06
	125A	BKH 4P C125	06141315	3	120,07

Kaçak Akım Koruma Şalterleri

AC Tipi Kaçak Akım Koruma Şalterleri, 240-415 VAC

	In	I _{Δn}	K. Kapasite	Model	Sipariş Kodu	Kutu Adedi	Liste Fiyatı (\$)	
RKN 1P+N 	25A	30mA	6 kA	RKN 1P+N 25A 30mA AC-	06220001	6	47,85	
	32A			RKN 1P+N 32A 30mA AC-	06220004	6	50,62	
	40A			RKN 1P+N 40A 30mA AC-	06220007	6	50,62	
	63A			RKN 1P+N 63A 30mA AC-	06220010	6	67,23	
	25A	300mA		RKN 1P+N 25A 300mA AC-	06220003	6	47,04	
	32A			RKN 1P+N 32A 300mA AC-	06220006	6	49,20	
	40A			RKN 1P+N 40A 300mA AC-	06220009	6	49,20	
	63A			RKN 1P+N 63A 300mA AC-	06220012	6	64,31	
	RKN 3P+N 	25A		30mA	RKN 3P+N 25A 30mA AC-	06240001	3	75,95
		32A			RKN 3P+N 32A 30mA AC-	06240004	3	79,03
		40A			RKN 3P+N 40A 30mA AC-	06240007	3	79,03
		63A			RKN 3P+N 63A 30mA AC-	06240010	3	88,67
25A		300mA	RKN 3P+N 25A 300mA AC-	06240003	3	65,18		
32A			RKN 3P+N 32A 300mA AC-	06240006	3	79,03		
40A			RKN 3P+N 40A 300mA AC-	06240009	3	68,81		
63A			RKN 3P+N 63A 300mA AC-	06240012	3	88,67		
RKN-b 1P+N 		25A	30mA	10 kA	RKN-b 1P+N 25A 30mA,	06220663	6	71,79
		32A			RKN-b 1P+N 32A 30mA,	06220666	6	71,79
		40A			RKN-b 1P+N 40A 30mA,	06220669	6	71,79
		63A			RKN-b 1P+N 63A 30mA,	06220672	6	77,68
	80A	RKN-b 1P+N 80A 30mA,			06220678	6	88,67	
	100A	RKN-b 1P+N 100A 30mA,			06220681	6	88,67	
	25A	300mA			RKN-b 1P+N 25A 300mA,	06220665	6	71,79
	32A				RKN-b 1P+N 32A 300mA,	06220668	6	71,79
	40A				RKN-b 1P+N 40A 300mA,	06220671	6	71,79
	63A				RKN-b 1P+N 63A 300mA,	06220674	6	77,68
	RKN-b 3P+N 	80A	30mA		RKN-b 1P+N 80A 300mA,	06220680	6	88,67
		100A			RKN-b 1P+N 100A 300mA,	06220683	6	88,67
		25A			RKN-b 3P+N 25A 30mA,	06240094	3	100,04
		32A			RKN-b 3P+N 32A 30mA,	06240097	3	100,04
		40A	RKN-b 3P+N 40A 30mA,		06240100	3	100,04	
		63A	RKN-b 3P+N 63A 30mA,		06240103	3	114,44	
		80A	RKN-b 3P+N 80A 30mA,		06240109	3	134,42	
		100A	RKN-b 3P+N 100A 30mA,		06240112	3	134,42	
25A		300mA	RKN-b 3P+N 25A 300mA,	06240096	3	100,04		
32A			RKN-b 3P+N 32A 300mA,	06240099	3	100,04		
40A	RKN-b 3P+N 40A 300mA,		06240102	3	100,04			
63A	RKN-b 3P+N 63A 300mA,		06240105	3	114,44			
80A	RKN-b 3P+N 80A 300mA,	06240111	3	134,42				
100A	RKN-b 3P+N 100A 300mA,	06240114	3	134,42				

A Tipi Kaçak Akım Koruma Şalterleri, 240-415 VAC

	In	I _{Δn}	K. Kapasite	Model	Sipariş Kodu	Kutu Adedi	Liste Fiyatı (\$)	
RKN 1P+N 	25A	30mA	10 kA	RKN 1P+N 25A 30mA	06220444	6	58,36	
	32A			RKN 1P+N 32A 30mA	06220447	6	61,76	
	40A			RKN 1P+N 40A 30mA	06220450	6	61,76	
	63A			RKN 1P+N 63A 30mA	06220453	6	82,02	
	25A	300mA		RKN 1P+N 25A 300mA	06220446	6	57,45	
	32A			RKN 1P+N 32A 300mA	06220449	6	60,14	
	40A			RKN 1P+N 40A 300mA	06220452	6	60,14	
	63A			RKN 1P+N 63A 300mA	06220455	6	78,45	
	RKN 3P+N 	25A		30mA	RKN 3P+N 25A 30mA	06220456	3	92,57
		32A			RKN 3P+N 32A 30mA	06220459	3	96,41
		40A			RKN 3P+N 40A 30mA	06220462	3	96,41
		63A			RKN 3P+N 63A 30mA	06220465	3	108,16
25A		300mA	RKN 3P+N 25A 300mA	06220458	3	79,53		
32A			RKN 3P+N 32A 300mA	06220461	3	96,41		
40A			RKN 3P+N 40A 300mA	06220464	3	96,41		
63A			RKN 3P+N 63A 300mA	06220467	3	108,16		
RKN-b 1P+N 		25A	30mA	RKN-b 1P+N 25A 30mA	06220749	6	87,58	
		32A		RKN-b 1P+N 32A 30mA	06220752	6	87,58	
		40A		RKN-b 1P+N 40A 30mA	06220755	6	87,58	
		63A		RKN-b 1P+N 63A 30mA	06220758	6	94,78	
	25A	300mA	RKN-b 1P+N 25A 300mA	06220751	6	87,58		
	32A		RKN-b 1P+N 32A 300mA	06220754	6	87,58		
	40A		RKN-b 1P+N 40A 300mA	06220757	6	87,58		
	63A		RKN-b 1P+N 63A 300mA	06220760	6	94,78		
	RKN-b 3P+N 	25A	30mA	RKN-b 1P+N 25A 30mA	06240148	6	122,01	
		32A		RKN-b 3P+N 32A 30mA	06240151	3	122,01	
		40A		RKN-b 3P+N 40A 30mA	06240154	3	122,01	
		63A		RKN-b 3P+N 63A 30mA	06240157	3	139,61	
25A		300mA	RKN-b 3P+N 25A 300mA	06240150	3	122,01		
32A			RKN-b 3P+N 32A 300mA	06240153	3	122,01		
40A			RKN-b 3P+N 40A 300mA	06240156	3	122,01		
63A			RKN-b 3P+N 63A 300mA	06240159	3	139,61		

Otomatik Sigortalı Kaçak Akım Koruma Şalterleri

	In	I _{Δn}	A. Eğrisi	Model	Sipariş Kodu	Kutu Adedi	Liste Fiyatı (\$)	
RKP 1P+N 	6A	30mA	B Tipi	RKP 1P+N B6A 30mA	06220123	6	38,55	
		300mA		RKP 1P+N B6A 300mA	06220124	6	38,55	
	10A	30mA		RKP 1P+N B10A 30mA	06220127	6	38,55	
		300mA		RKP 1P+N B10A 300mA	06220129	6	38,55	
	16A	30mA		RKP 1P+N B16A 30mA	06220131	6	38,55	
		300mA		RKP 1P+N B16A 300mA	06220133	6	38,55	
	20A	30mA		RKP 1P+N B20A 30mA	06220135	6	38,55	
		300mA		RKP 1P+N B20A 300mA	06220137	6	38,55	
	25A	30mA		RKP 1P+N B25A 30mA	06220139	6	38,55	
		300mA		RKP 1P+N B25A 300mA	06220141	6	38,55	
	32A	30mA		RKP 1P+N B32A 30mA	06220143	6	38,55	
		300mA		RKP 1P+N B32A 300mA	06220145	6	38,55	
	3A	30mA		C Tipi	RKP 1P+N C3A 30mA	06220147	6	38,55
		300mA			RKP 1P+N C3A 300mA	06220149	6	38,55
	6A	30mA			RKP 1P+N C6A 30mA	06220151	6	38,55
		300mA			RKP 1P+N C6A 300mA	06220153	6	38,55
	10A	30mA			RKP 1P+N C10A 30mA	06220155	6	38,55
		300mA			RKP 1P+N C10A 300mA	06220157	6	38,55
	16A	30mA			RKP 1P+N C16A 30mA	06220159	6	38,55
		300mA			RKP 1P+N C16A 300mA	06220161	6	38,55
	20A	30mA			RKP 1P+N C20A 30mA	06220163	6	38,55
		300mA			RKP 1P+N C20A 300mA	06220165	6	38,55
	25A	30mA			RKP 1P+N C25A 30mA	06220167	6	38,55
		300mA			RKP 1P+N C25A 300mA	06220169	6	38,55
32A	30mA	RKP 1P+N C32A 30mA	06220171		6	38,55		
	300mA	RKP 1P+N C32A 300mA	06220173		6	38,55		

Top 100
Global
Innovator
for 10 years

Sessiz Kontaktörler, Darbe Akım Anahtarları



LS ELECTRIC

Sessiz Kontaktörler (AC-1)

Model	Anma Akımı	Kontakt Sayısı	Kontakt Yapısı	Kutu Adeti	Sipariş Kodu	Açıklama	Liste Fiyatı(\$)
MOC-16a	16A	2 Kontakt	2NA	8	27590013	MOC-16a AC230V 2P 2NA	21,01
			1NA1NK	8	27590015	MOC-16a AC230V 2P 1NA1NK	21,01
MOC-20a	25A		2NA	8	27590079	MOC-25a AC230V 2P 2NA	21,01
			1NA1NK	8	27590081	MOC-25a AC230V 2P 1NA1NK	21,01
MOC-32a	32A		2NA	8	27590106	MOC-32a AC230V 2P 2NA	35,31
			1NA1NK	8	27590108	MOC-32a AC230V 2P 1NA1NK	35,31
MOC-40a	40a		2NA	8	27590133	MOC-40a AC230V 2P 2NA	35,31
			1NA1NK	8	27590135	MOC-40a AC230V 2P 1NA1NK	35,31
MOC-63a	63A		2NA	8	27590160	MOC-63a AC230V 2P 2NA	41,16
			1NA1NK	8	27590162	MOC-63a AC230V 2P 1NA1NK	41,16
MOC-16a	16A	4 Kontakt	4NA	6	27590030	MOC-16a AC230V 4P 4NA	37,57
			2NA2NK	6	27590032	MOC-16a AC230V 4P 2NA2NK	37,57
MOC-20a	25A		4NA	6	27590096	MOC-25a AC230V 4P 4NA	37,57
			2NA2NK	6	27590098	MOC-25a AC230V 4P 2NA2NK	37,57
MOC-32a	32A		4NA	6	27590123	MOC-32a AC230V 4P 4NA	49,70
			2NA2NK	6	27590125	MOC-32a AC230V 4P 2NA2NK	49,70
MOC-40a	40a		4NA	6	27590150	MOC-40a AC230V 4P 4NA	49,70
			2NA2NK	6	27590152	MOC-40a AC230V 4P 2NA2NK	49,70
MOC-63a	63A		4NA	6	27590177	MOC-63a AC230V 4P 4NA	62,04
			2NA2NK	6	27590179	MOC-63a AC230V 4P 2NA2NK	62,04

Sessiz Kontaktör Aksesuarları

Model	Anma Akımı	Çalışma Gerilimi	Kutu Adeti	Sipariş Kodu	Açıklama	Liste Fiyatı(\$)
27610001	16A	AC230V/DC110V	12	27620005	MOI-16/10 AC230V/DC110V 1P	8,73
27610002	16A	AC230V/DC110V	12	27620015	MOI-16/11 AC230V/DC110V 1P	8,73
27610003	16A	AC48V/DC24V	12	27620003	MOI-16/10 AC48V/DC24V 1P	1,97

Darbe Akım Anahtarları

Model	Anma Akımı	Çalışma Gerilimi	Kutu Adeti	Sipariş Kodu	Açıklama	Liste Fiyatı(\$)
MOR-16/10	16A	AC230V/DC110V	12	27620005	MOI-16/10 AC230V/DC110V 1P	25,64
MOR-16/11	16A	AC230V/DC110V	12	27620015	MOI-16/11 AC230V/DC110V 1P	31,24
MOR-16/10	16A	AC48V/DC24V	12	27620003	MOI-16/10 AC48V/DC24V 1P	25,64
MOR-16/11	16A	AC48V/DC24V	12	27620013	MOI-16/11 AC48V/DC24V 1P	31,24

Sessiz Kontaktörler

Auto



Manuel



MOC	25	a	AC230V	1P	1NO1NC
Model	Anma Akımı	Tip	Kontrol Gerilimi	Kontakt	Kontakt Yapısı
	16A	a Auto	AC 24V	1P	1NO
	20A	m Manual	AC 110V	2P	1NC
	25A		AC 230V	3P	1NO1NC
	32A			4P	2NO
	40A				2NC
	63A				3NO
	100A				3NC
					2NO2NC
					4NO
					2NO2NC
					3NO1NC
					4NC

Darbe Akım Anahtarları



MOI	16	10	AC230V
Model	Anma Akımı	Kontakt Yapısı	Kontrol Gerilimi
	16A	10	AC12V / DC6V
		1NO	AC24V / DC12V
		2NO	AC48V / DC24V
		11	AC110V / DC48V
		1C/O(SPDT)	AC230V / DC110V

Manyetik Güç Kontaktörleri ve Termik Röleler

Kontaktörler

MC-6a

Anma Akımı	
6a	6A
⋮	
2650a	2650A
9b	9A
⋮	
22b	22A

R

Tip	
-	Standart
R	Ters
4	4 Kutup

220V

Bobin Voltajı
AC 220V
⋮
DC 24V

50Hz

Frekans
60Hz
50Hz
50/60HZ

SCREW

-
Screw
LUG

1a1b

Yardımcı Kontakt
-
1a1b
2a2b
1a
1b



18AF



22AF



40AF



65AF



100AF



150AF

18AF

Kontaktör

MC-6a, 9a, 12a, 18a

Anma akımı
6, 9, 12, 18A
İzolasyon gerilimi
690V

Termik Röle MT-12

Akım aralığı: 0.1~18A
Hata sınıfı: 10A, 20

22AF

Kontaktör

MC-9b, 12b, 18b, 22b

Anma akımı
9, 12, 18, 22A
İzolasyon gerilimi
690V

Termik Röle MT-32

Akım aralığı: 0.1~40A
Hata sınıfı: 10A, 20

40AF

Kontaktör

MC-32a, 40a

Anma akımı
32, 40A
İzolasyon gerilimi
1000V

Termik Röle MT-32

Akım aralığı: 0.1~40A
Hata sınıfı: 10A, 20

65AF

Kontaktör

MC-50a, 65a

Anma akımı
50, 65A
İzolasyon gerilimi
1000V

Termik Röle MT-63

Akım aralığı: 4~65A
Hata sınıfı: 10A, 20

100AF

Kontaktör

MC-75a, 85a, 100a

Anma akımı
75, 85, 100A
İzolasyon gerilimi
1000V

Termik Röle MT-95

Akım aralığı: 7~100A
Hata sınıfı: 10A, 20

150AF

Kontaktör

MC-130a, 150a

Anma akımı
130, 150A
İzolasyon gerilimi
1000V

Termik Röle MT-150

Akım aralığı: 34~150A
Hata sınıfı: 10A, 20

Termik Röle

MT-12

Anma Akımı	
12	12AF
32	32AF
63	63AF
95	95AF
⋮	
800	800AF

/

2H

Röle Tipi	
2H	Non-differential (2-heater)
3H	Non-differential (3-heater)
3K	Differential
3D	Class 20

0.1

Ayar Akımı	
0.1	0.1A
⋮	
800	800A



225AF

Kontaktör

MC-185a, 225a

Anma akımı
185, 225A
İzolasyon gerilimi
1000V

Termik Röle MT-225

Akım aralığı: 65~240A
Hata sınıfı: 10A, 20

400AF

Kontaktör

MC-265a, 330a, 400a

Anma akımı
265, 330, 400A
İzolasyon gerilimi
1000V

Termik Röle MT-400

Akım aralığı: 85~400A
Hata sınıfı: 10A, 20

800AF

Kontaktör

MC-500a, 630a, 800a

Anma akımı
500, 630, 800A
İzolasyon gerilimi
1000V

Termik Röle MT-800

Akım aralığı: 200~800A
Hata sınıfı: 10A, 20

1260AF

Kontaktör

MC-1260a

Anma akımı
1260A
İzolasyon gerilimi
1000V

2650AF

Kontaktör

MC-1400a, 1700a, 2100a,
2650a

Anma akımı
1400, 1700, 2100, 2650A
İzolasyon gerilimi
1000V

Manyetik Güç Kontaktörleri

3 Kutuplu Güç Kontaktörleri (Bobin devresi 220VAC)

Model	Anma Gücü (kW) (400VAC)	Termik Akımı (A) AC1	Termik Akımı (A) AC3	Yardımcı Kontak	Sipariş Kodu	Açıklama	Liste Fiyatı(\$)
MC-6a	3 kW	25 A	7 A	1 NA	13270007	MC-6a AC220V 50/60Hz 1a	24,95
	3 kW	25 A	7 A	1 NK	13270069	MC-6a AC220V 50/60Hz 1b	24,95
MC-9a	4 kW	25 A	9 A	1 NA	13160007	MC-9a AC220V 50/60Hz 1a	25,71
	4 kW	25 A	9 A	1 NK	13160069	MC-9a AC220V 50/60Hz 1b	25,71
MC-12a	5,5 kW	25 A	12 A	1 NA	13170007	MC-12a AC220V 50/60Hz 1a	26,42
	5,5 kW	25 A	12 A	1 NK	13170069	MC-12a AC220V 50/60Hz 1b	26,42
MC-18a	7,5 kW	32 A	18 A	1 NA	13280007	MC-18a AC220V 50/60Hz 1a	35,86
	7,5 kW	32 A	18 A	1 NK	13280069	MC-18a AC220V 50/60Hz 1b	35,86
MC-9b	4 kW	25 A	9A	1NA+1NK	13440007	MC-9b AC220V 50/60Hz 1a1b	27,53
MC-12b	5,5 kW	27 A	12A	1NA+1NK	13450007	MC-12b AC220V 50/60Hz 1a1b	30,15
MC-18b	7,5 kW	40 A	18A	1NA+1NK	13460007	MC-18b AC220V 50/60Hz 1a1b	38,83
MC-22b	11 kW	45 A	22A	1NA+1NK	13470007	MC-22b AC220V 50/60Hz 1a1b	51,05
MC-32a	15 kW	55 A	32A	1NA+1NK	13360069	MC-32a AC220V 50/60Hz 1a1b	62,86
MC-40a	18,5 kW	60 A	40A	1NA+1NK	13370069	MC-40a AC220V 50/60Hz 1a1b	86,61
MC-50a	22 kW	100 A	50A	1NA+1NK	13380069	MC-50a AC220V 50/60Hz 1a1b	114,42
MC-65a	30 kW	115 A	65A	1NA+1NK	13390069	MC-65a AC220V 50/60Hz 1a1b	131,06
MC-75a	37 kW	125 A	75A	1NA+1NK	13400069	MC-75a AC220V 50/60Hz 1a1b	151,08
MC-85a	45 kW	135 A	85A	1NA+1NK	13410069	MC-85a AC220V 50/60Hz 1a1b	180,28
MC-100a	55 kW	160 A	105A	1NA+1NK	13420069	MC-100a AC220V 50/60Hz 1a1b	243,97
MC-130a*	60 kW	200 A	130A	2NA+2NK	13620312	MC-130a AC100-240V 50/60Hz, DC100-220V 2a2b	303,64
MC-150a*	75 kW	250 A	150A	2NA+2NK	13640321	MC-150a AC100-240V 50/60Hz, DC100-220V 2a2b	388,80
MC-185a*	90 kW	300 A	185A	2NA+2NK	13660002	MC-185a AC100-240V 50/60Hz, DC100-220V 2a2b	488,80
MC-225a*	132 kW	350 A	225A	2NA+2NK	13680002	MC-225a AC100-240V 50/60Hz, DC100-220V 2a2b	592,43
MC-265a*	147 kw	400 A	265A	2NA+2NK	13690002	MC-265a AC100-240V 50/60Hz, DC100-220V 2a2b	796,11
MC-330a*	160 kW	500 A	330A	2NA+2NK	13700002	MC-330a AC100-240V 50/60Hz, DC100-220V 2a2b	866,41
MC-400a*	200 kW	520 A	400A	2NA+2NK	13710002	MC-400a AC100-240V 50/60Hz, DC100-220V 2a2b	999,75
MC-500a*	265 kW	700 A	500A	2NA+2NK	13720002	MC-500a AC100-240V 50/60Hz, DC100-220V 2a2b	1995,81
MC-630a*	330 kW	900 A	630A	2NA+2NK	13730002	MC-630a AC100-240V 50/60Hz, DC100-220V 2a2b	2106,95
MC-800a*	440 kW	1050 A	800 A	2NA+2NK	13740002	MC-800a AC100-240V 50/60Hz, DC100-220V 2a2b	2699,40
MC-1260a*	500 kW	1260 A	815A	2NA+2NK	13740306	MC-1260a AC100-240V 50/60Hz, DC100-220V 2a2b	4873,25
MC-1400a*	550 kW	1400 A	860A	2NA+2NK	14050001	MC-1400a AC100-240V 50/60Hz, DC100-220V 2a2b	8771,87
MC-1700a*	700 kW	1700 A	1050A	2NA+2NK	14050002	MC-1700a AC100-240V 50/60Hz, DC100-220V 2a2b	11500,88
MC-2100a*	900 kW	2100 A	1450A	2NA+2NK	14050003	MC-2100a AC100-240V 50/60Hz, DC100-220V 2a2b	14619,76

4 Kutuplu Güç Kontaktörleri (Bobin devresi 220VAC)

Model	Anma Gücü (kW) (400VAC1)	Anma Gücü (kW) (400VAC3)	Termik Akımı (A) AC1	Termik Akımı (A) AC3	Yardımcı Kontak	Sipariş Kodu	Açıklama	Liste Fiyatı(\$)
MC-9a/4	17 kW	4 kW	25 A	9A	-	13160129	MC-9a AC220V 50/60Hz 4P	35,86
MC-12a/4	17 kW	5,5 kW	25 A	12A	-	13170126	MC-12a AC220V 50/60Hz 4P	39,64
MC-18a/4	27 kW	7,5 kW	40 A	18A	-	13280126	MC-18a AC220V 50/60Hz 4P	52,88
MC-22b/4	27 kW	11 kW	40 A	22A	-	13470065	MC-22a AC220V 50/60Hz 4P	65,24
MC-32a/4	35 kW	15 kW	50 A	32A	-	13360188	MC-32a AC220V 50/60Hz 4P	98,46
MC-40a/4	42,5 kW	18,5 kW	60 A	40A	-	13370191	MC-40a AC220V 50/60Hz 4P	114,61
MC-50a/4	56 kW	22 kW	80A	50A	-	13380195	MC-50a AC220V 50/60Hz 4P	166,61
MC-65a/4	70 kW	30 kW	100 A	65A	-	13390192	MC-65a AC220V 50/60Hz 4P	192,54
MC-75a/4	76 kW	37 kW	110 A	75A	-	13400193	MC-75a AC220V 50/60Hz 4P	248,11
MC-85a/4	95 kW	45 kW	135 A	85A	-	13410193	MC-85a AC220V 50/60Hz 4P	270,30
MC-100a/4*	106 kW	55 kW	200 A	105A	2NA + 2NK	13420192	MC-100a AC/DC100-200V 2a2b 4P	481,38
MC-130a/4*	110 kW	60 kW	250 A	120A	2NA + 2NK	13620034	MC-130a AC/DC100-200V 2a2b 4P	555,48
MC-150a/4*	142 kW	75 kW	275 A	150A	2NA + 2NK	13640034	MC-150a AC/DC100-200V 2a2b 4P	648,01
MC-185a/4*	165 kW	90 kW	300 A	185A	2NA + 2NK	13660008	MC-185a AC/DC100-200V 2a2b 4P	703,53
MC-225a/4*	185 kW	132 kW	350 A	225A	2NA + 2NK	13680008	MC-225a AC/DC100-200V 2a2b 4P	814,63
MC-265a/4*	215 kw	147 kw	400 A	265A	2NA + 2NK	13690006	MC-265a AC/DC100-200V 2a2b 4P	1296,02
MC-330a/4*	250 kW	160 kW	500 A	330A	2NA + 2NK	13700006	MC-330a AC/DC100-200V 2a2b 4P	1407,06
MC-400a/4*	300 kW	200 kW	520 A	400A	2NA + 2NK	13710006	MC-400a AC/DC100-200V 2a2b 4P	1518,15
MC-500a/4*	450 kW	265 kW	700 A	500A	2NA + 2NK	13720007	MC-500a AC/DC200V 2a2b 4P	2406,85
MC-630a/4*	470 kW	330 kW	900 A	630A	2NA + 2NK	13730007	MC-630a AC/DC200V 2a2b 4P	2591,97
MC-800a/4*	570 kW	440 kW	1050 A	800 A	2NA + 2NK	13740007	MC-800a AC/DC200V 2a2b 4P	3147,40

* Bobin devresi AC/DC beslemelidir.

3 Kutuplu Güç Kontaktörleri (Bobin devresi 24VAC)

Model	Anma Gücü (kW) (400VAC)	Termik Akımı (A) AC1	Termik Akımı (A) AC3	Yardımcı Kontak	Sipariş Kodu	Açıklama	Liste Fiyatı(\$)
MC-6a	3 kW	25 A	7 A	1 NA	13270001	MC-6a AC24V 50/60Hz 1a	24,95
	3 kW	25 A	7 A	1 NK	13270063	MC-6a AC24V 50/60Hz 1b	24,95
MC-9a	4 kW	25 A	9 A	1 NA	13160016	MC-9a AC24V 50/60Hz 1a	25,71
	4 kW	25 A	9 A	1 NK	13160063	MC-9a AC24V 50/60Hz 1b	25,71
MC-12a	5,5 kW	25 A	12 A	1 NA	13170001	MC-12a AC24V 50/60Hz 1a	26,42
	5,5 kW	25 A	12 A	1 NK	13170063	MC-12a AC24V 50/60Hz 1b	26,42
MC-18a	7,5 kW	32 A	18 A	1 NA	13280001	MC-18a AC24V 50/60Hz 1a	35,86
	7,5 kW	32 A	18 A	1 NK	13280063	MC-18a AC24V 50/60Hz 1b	35,86
MC-9b	4 kW	25 A	9A	1NA+1NK	13440001	MC-9b AC24V 50/60Hz 1a1b	27,53
MC-12b	5,5 kW	27 A	12A	1NA+1NK	13450001	MC-12b AC24V 50/60Hz 1a1b	30,15
MC-18b	7,5 kW	40 A	18A	1NA+1NK	13460001	MC-18b AC24V 50/60Hz 1a1b	38,83
MC-22b	11 kW	45 A	22A	1NA+1NK	13470001	MC-22b AC24V 50/60Hz 1a1b	51,05
MC-32a	15 kW	55 A	32A	1NA+1NK	13360063	MC-32a AC24V 50/60Hz 1a1b	62,86
MC-40a	18,5 kW	60 A	40A	1NA+1NK	13370063	MC-40a AC24V 50/60Hz 1a1b	86,61
MC-50a	22 kW	100 A	50A	1NA+1NK	13380063	MC-50a AC24V 50/60Hz 1a1b	114,42
MC-65a	30 kW	115 A	65A	1NA+1NK	13390063	MC-65a AC24V 50/60Hz 1a1b	131,06
MC-75a	37 kW	125 A	75A	1NA+1NK	13400063	MC-75a AC24V 50/60Hz 1a1b	151,08
MC-85a	45 kW	135 A	85A	1NA+1NK	13410063	MC-85a AC24V 50/60Hz 1a1b	180,28
MC-100a	55 kW	160 A	105A	1NA+1NK	13420063	MC-100a AC24V 50/60Hz 1a1b	243,97
MC-130a	60 kW	200 A	130A	1NA+1NK	13620013	MC-130a AC24V 50/60Hz 1a1b	295,82
MC-150a	75 kW	250 A	150A	1NA+1NK	13640013	MC-150a AC24V 50/60Hz 1a1b	381,05
MC-185a*	90 kW	300 A	185A	2NA+2NK	13660003	MC-185a AC24-25V 50/60Hz, DC24V 2a2b	488,80
MC-225a*	132 kW	350 A	225A	2NA+2NK	13680003	MC-225a AC24-25V 50/60Hz, DC24V 2a2b	592,43

3 Kutuplu Güç Kontaktörleri (Bobin devresi DC)

Model	Anma Gücü (kW) (400VAC)	Termik Akımı (A) AC1	Termik Akımı (A) AC3	Yardımcı Kontak	Sipariş Kodu	Açıklama	Liste Fiyatı(\$)
MC-9b/DC	4kW	25A	9A	1NA + 1NK Kontak	13441003	MC-9b DC24V 1a1b	41,51
					13441004	MC-9b DC48V 1a1b	41,51
MC-12b/DC	5,5kW	25A	12A		13451003	MC-12b DC24V 1a1b	49,09
					13451004	MC-12b DC48V 1a1b	70,13
MC-18b/DC	7,5kW	40A	18A		13461003	MC-18b DC24V 1a1b	66,82
					13461004	MC-18b DC48V 1a1b	66,82
MC-22b/DC	11kW	45A	22A		13471003	MC-22b DC24V 1a1b	77,09
					13471004	MC-22b DC48V 1a1b	77,09
MC-32a/DC	15kW	55A	32A		13360115	MC-32a DC24V 1a1b	94,50
					13360116	MC-32a DC48V 1a1b	94,50
MC-40a/DC	18,5kW	60A	40A		13370115	MC-40a DC24V 1a1b	108,36
					13370116	MC-40a DC48V 1a1b	108,36
MC-50a/DC	22kW	100A	50A		13380115	MC-50a DC24V 1a1b	140,34
					13380116	MC-50a DC48V 1a1b	140,34
MC-65a/DC	30kW	115A	65A		13390115	MC-65a DC24V 1a1b	177,41
					13390116	MC-65a DC48V 1a1b	177,41
MC-75a/DC	37kW	125A	75A		13400115	MC-75a DC24V 1a1b	232,83
					13400116	MC-75a DC48V 1a1b	232,83
MC-85a/DC	45kW	135A	85A		13410115	MC-85a DC24V 1a1b	277,36
					13410116	MC-85a DC48V 1a1b	277,36
MC-100a/DC	55kW	160A	105A	13420115	MC-100a DC24V 1a1b	284,77	
				13420116	MC-100a DC48V 1a1b	284,77	
MC-130a/DC	60kW	200A	130A	13620019	MC-130a DC24V 1a1b	344,02	
				13620020	MC-130a DC48V 1a1b	295,82	
MC-150a/DC	75kW	250A	150A	13640019	MC-150a DC24V 1a1b	425,47	
				13640020	MC-150a DC48V 1a1b	381,05	
MC-185a*	90kW	300A	185A	2NA + 2NK Kontak	13660003	MC-185a AC24-25V 50/60Hz, DC24V 2a2b	488,80
MC-225a*	132kW	350A	225A		13680003	MC-225a AC24-25V 50/60Hz, DC24V 2a2b	592,43

* Bobin devresi AC/DC beslemelidir.

Metasol Serisi Kontaktörler için Yardımcı Donanımlar

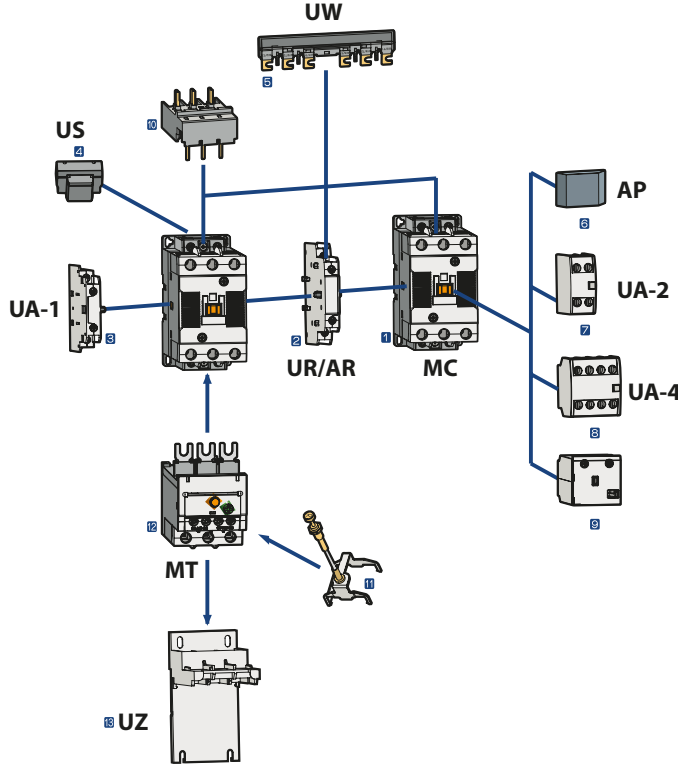

- 1 Kontaktör
- 2 Kilit Ünitesi
- 3 Yardımcı Kontak (yana montaj)
- 4 Varistör Ünitesi
- 5 Besleme Barası
- 6 Koruma Kapağı
- 7 Yardımcı Kontak (üzerine montaj - 2P)
- 8 Yardımcı Kontak (üzerine montaj - 4P)
- 9 Mekanik Kilit Ünitesi
- 10 Direk Bağlantı Adaptörü
- 11 Uzaktan Reset Ünitesi
- 12 Termik Röle
- 13 Raya Montaj Adaptörü

Yardımcı Kontaktör

MR	/	4
Kutup		
4		4 Kutup
6		6 Kutup
8		8 Kutup

Yardımcı Kontaktörler (MR-4)

Model	Kontak Sayısı	Çalışma Gerilimi	Yardımcı Kontak	Sipariş Kodu	Açıklama	Liste Fiyatı(\$)
MR-4	4	DC 24V	4 NK	13891015	MR-4 DC24V 4a	43,48
			3 NK - 1 NA	13891027	MR-4 DC24V 3a1b	43,48
			2 NK - 2 NA	13891003	MR-4 DC24V 2a2b	43,48
		DC 110V	4 NK	13891020	MR-4 DC110V 4a	43,48
			3 NK - 1 NA	13891032	MR-4 DC110V 3a1b	43,48
			2 NK - 2 NA	13891008	MR-4 DC110V 2a2b	43,48
		AC 24V	4 NK	13890015	MR-4 AC24V 4a	35,93
			3 NK - 1 NA	13890029	MR-4 AC24V 3a1b	35,93
			2 NK - 2 NA	13890001	MR-4 AC24V 2a2b	35,93
		AC 220V	4 NK	13890021	MR-4 AC220V 4a	35,93
			3 NK - 1 NA	13890035	MR-4 AC220V 3a1b	35,93
			2 NK - 2 NA	13890007	MR-4 AC220V 2a2b	35,93
AC 110V	4 NK	13890018	MR-4 AC110V 4a	35,93		
	3 NK - 1 NA	13890032	MR-4 AC110V 3a1b	35,93		
	2 NK - 2 NA	13890004	MR-4 AC110V 2a2b	35,93		

Yardımcı Kontak Üniteleri

Model	Yardımcı Kontak Sayısı	Birlikte Kullanılacağı Kontaktör		Sipariş Kodu	Montaj Şekli	Liste Fiyatı(\$)			
		3P	4P						
AU-1	1NK+1NA/GMC-9-85		MC-22a/4 - 85a/4	83361611001	YANINA TAKILAN	7,78			
UA-1	1NA+1NK		MC-6a/4-MC180a/4	83361634001		7,78			
UA-2	2NA	MC-6a-MC-150a	MC-22a/4-MC-85a/4	83361634064	ÜZERİNE TAKILAN	7,78			
UA-2	1NA+1NK			83361634066		7,78			
UA-2	2NK			83361634068		7,78			
UA-4	4A			83361634044		12,61			
UA-4	1NA+3NK			83361634046		12,61			
UA-4	2NA+2NK			83361634048		12,61			
UA-4	3A+1NK			83361634050		12,61			
UA-4	4NK			83361634052		12,61			
AU-100	1NK+1NA/GMC-100-800			MC-185a-MC-2100a		MC-100a-MC-800a/4	83361614001	YANINA TAKILAN	12,96
AU-100	2NK+2NA/GMC-100-800						83361614007		12,96
AU-100	ADD 1NK+1NA/GMC-100-800	83361614009	12,96						
AU-100E	1NK+1NA/GMC-100-800	83361614016	17,40						

Kapasitör Ünitesi



Kapasitör Ünitesi

Birlikte kullanılacağı kontaktör	400-440V	Sipariş Kodu	Açıklama	Liste Fiyatı(\$)
MC-12b	12.5kVar	83631611001	AC9	28,89
MC-18b	16.7kVar			
MC-22b	18kVar			
MC-32a	25kVar			
MC-40a	33.3kVar	83631613001	AC50	40,80
MC-50a	40kVar			
MC-65a	45.7kVar	83631613009	AC75	40,80
MC-75a	54kVar			
MC-85a	60kVar			
MC-100a	62kVar			



Not: Fiyatlar, Kapasitör ünitesi fiyatlarıdır. Kontaktör ayrıca satın alınmalıdır.

Pnömatik Zaman Röleleri



Model	Birlikte kullanılacağı kontaktör		Sipariş Kodu	Açıklama	Liste Fiyatı(\$)
		NOT			
UN-1N	MC-6a ~ MC-100a MC-9b ~ MC-22b	ÇEKMEDE GECİKMELİ	83561634007	Pnömatik Zaman Rölesi 0,1-3 sn. 1NA+1NK	62,18
UN-2N		ÇEKMEDE GECİKMELİ	83561634008	Pnömatik Zaman Rölesi 0,1-30 sn. 1NA+1NK	62,18
UN-3N		ÇEKMEDE GECİKMELİ	83561634009	Pnömatik Zaman Rölesi 10-180 sn. 1NA+1NK	62,18
UN-1F		DÜŞMEDE GECİKMELİ	83561634010	Pnömatik Zaman Rölesi 0,1-3 sn. 1NA+1NK	62,18
UN-3F		DÜŞMEDE GECİKMELİ	83561634012	Pnömatik Zaman Rölesi 10-180 sn. 1NA+1NK	62,18

Zaman Röleleri



Model	Birlikte kullanılacağı kontaktör		Sipariş Kodu	Besleme Gerilimi	Açıklama	Liste Fiyatı(\$)
		NOT				
UT-1N	MC-6a ~ MC-150a MC-9b ~ MC-22b MR4-8	ÇEKMEDE GECİKMELİ	83391634001	AC/DC 24-48V	Zaman Rölesi 1-30 saniye ayar sahası	88,17
UT-2N		ÇEKMEDE GECİKMELİ	83391634002	AC 110-220V		88,17
UT-1F		DÜŞMEDE GECİKMELİ	83391634003	AC/DC 24-48V		88,17
UT-2F		DÜŞMEDE GECİKMELİ	83391634004	AC 110-220V		88,17

Varistor Üniteleri



Model	Kullanıldığı Ürün	Sipariş Kodu	Açıklama	Liste Fiyatı(\$)
US-11	3P - MC-6a-MC-150a 3P - MC-9b-MC-22b 4P - MC-6a/4-MC-18a/4	83611634007	VARİSTÖR,US-11,AC/DC24~48V,MC-9-95	10,74
US-12		83611634008	VARİSTÖR,US-12,AC/DC100~125V,MC-9-95	10,74
US-13		83611634009	VARİSTÖR,US-13,AC/DC200~240V,MC-9-95	10,74
US-14		83611634010	VARİSTÖR,US-14,AC380~440V,MC-9-95	10,74
US-22		83611634011	VARİSTÖR,US-22,AC100~125V,MC-9-95	10,74

İzolasyon Bariyerleri



Model	Birlikte Kullanılacağı Kontaktör		Sipariş Kodu	Açıklama	Liste Fiyatı(\$)
	3P	4P			
AI-180	MC-130a-400a	MC-130a-400a	83511616001	KONTAKTÖR BARIYER ÜNİTESİ AI-180,GMC-180-400	1,31
AI-800	MC-500a-1260a	MC-500a-1260a	83511618001	KONTAKTÖR BARIYER ÜNİTESİ AI-600,GMC-600-800	2,22

Manyetik Güç Kontaktörleri

Yardımcı Donanımlar

Terminal Kapakları



Model	Birlikte Kullanılacağı Kontaktör		Sipariş Kodu	Açıklama	Liste Fiyatı(\$)
	3P	4P			
AP220	MC-185a~225a		64611614006	KONTAKTÖR TERMİNAL KAPAĞI GMC-180/220	8,52
AP400	MC-265a~400a		64611614007	KONTAKTÖR TERMİNAL KAPAĞI GMC-300/400	11,85
AP800	MC-500a~800a		64611614008	KONTAKTÖR TERMİNAL KAPAĞI GMC-600/800	18,56
AP220		MC-185a~225a	64621616001	KONTAKTÖR TERMİNAL KAPAĞI GMC-100/220-4	9,28
AP400		MC-265a~400a	64621617001	KONTAKTÖR TERMİNAL KAPAĞI GMC-300/400-4	13,93
AP800		MC-500a~800a	64621618002	KONTAKTÖR TERMİNAL KAPAĞI GMC-600/800-4	23,15

Koruma Kapakları

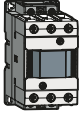

Model	Birlikte Kullanılacağı Kontaktör	Sipariş Kodu	Açıklama	Liste Fiyatı(\$)
AP-9	MC-6a~150a	64611611205	KORUMA KAPAĞI MC-6a - 150a	0,38
AP-185	MC-185a~800a	64611642002	KORUMA KAPAĞI MC-185a - 800a	1,29

Mekanik Kilit Üniteleri

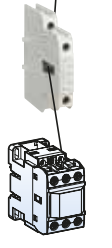
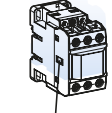

Model	Birlikte Kullanılacağı Kontaktör		Sipariş Kodu	Açıklama	Liste Fiyatı(\$)
	3P	4P			
UR-02	MC-6a~18a & MC-9b~22b & MC-32a~150a	MC-9a~18a	83411634001	MEKANİK KİLİT ÜNİTESİ,UR-02,MC-9R-95R	16,69
AR-9		MC-22a~85a	83411611003	MEKANİK KİLİT ÜNİTESİ AR-09(AYRIK)G-MC-9R-95R	16,69
AR-180	MC-185a~400a	MC-100a~400a	83411616001	MEKANİK KİLİT ÜNİTESİ AR-180a-GMC-180R-400R	53,70
AR-400DV	MC-265a~400a & 500a~800a		56121618011	MEKANİK KİLİT ÜNİTESİ AR-400-600V (AYRIK) 3P DİKEY	851,64
AR-600	MC-500a~800a		56121618001	MEKANİK KİLİT ÜNİTESİ AR-600V (AYRIK) 3P YATAY	851,64
AR-600V	MC-500a~800a		56121618002	MEKANİK KİLİT ÜNİTESİ AR-600V (AYRIK) 3P DİKEY	851,64
AR-600/4		MC-500a~800a 4P	56121618003	MEKANİK KİLİT ÜNİTESİ AR-600(AYRIK) 4P YATAY	851,64
AR-600/4V		MC-500a~800a 4P	56121618004	MEKANİK KİLİT ÜNİTESİ AR-600(AYRIK) 4P DİKEY	851,64

Kutulu Tip Yolvericiler (metal / plastik kutulu)*



Model	AC3 Akımı (IEC 60947-4-1)					Birlikte Kullanılacak	
	200-400V	380-400V	500-550V	690V	1000V	Kontaktör	Termik Röle
MW-6a(B)	2.2kW 9A	3kW 7A	3kW 6A	3kW 4A	-	MC-6a	MT-12 (0.1~18A)
MW-9a(B)	2.5kW 11A	4kW 9A	4kW 7A	4kW 5A	-	MC-9a	
MW-12a(B)	3.5kW 13A	5.5kW 12A	7.5kW 12A	7.5kW 9A	-	MC-12a	
MW-18a(B)	4.5kW 18A	7.5kW 18A	7.5kW 13A	7.5kW 9A	-	MC-18a	MT-32 (0.1~22A)
MW-9b(B)	2.5kW 11A	4kW 9A	4kW 7A	4kW 6A	-	MC-9b	
MW-12b(B)	3.5kW 13A	5.5kW 12A	7.5kW 12A	7.5kW 9A	-	MC-12b	
MW-18b(B)	4.5kW 18A	7.5kW 18A	7.5kW 13A	7.5kW 9A	-	MC-18b	MT-32 (0.1~40A)
MW-22b(B)	5.5kW 22A	11kW 22A	15kW 20A	15kW 18A	-	MC-22b	
MW-32a(B)	7.5kW 32A	15kW 32A	18.5kW 28A	18.5kW 20A	22kW 17A	MC-32a	
MW-40a(B)	11kW 40A	18.5kW 40A	22kW 32A	22kW 23A	22kW 17A	MC-40a	MT-63 (4~65A)
MW-50a(B)	15kW 55A	22kW 50A	30kW 43A	30kW 28A	30kW 23A	MC-50a	
MW-65a(B)	18.5kW 65A	30kW 65A	33kW 60A	33kW 35A	33kW 26A	MC-65a	
MW-75a(B)	22kW 75A	37kW 75A	37kW 64A	37kW 42A	37kW 28A	MC-75a	MT-95 (7~100A)
MW-85a(B)	25kW 85A	45kW 85A	45kW 75A	45kW 45A	45kW 33A	MC-85a	
MW-100a(B)	30kW 105A	55kW 105A	55kW 85A	55kW 65A	45kW 33A	MC-100a	



* Fiyat bilgisi için yetkili satış kanallarımız ile temasa geçebilirsiniz.

Yardımcı Donanımlar

MT Serisi Termik Röleler

Model	Birlikte Kullanılacağı Kontaktör	Termik Ayar Sahası	Anma Akımı In (A)	Sipariş Kodu	Açıklama	Liste Fiyatı(\$)
MT-12	MC-6a / MC-9a / MC-12a / MC-18a	0.1-0.16	0.14A	13190001	MT-12 0.14A 3H	30,15
		0.16-0.25	0.21A	13190002	MT-12 0.21A 3H	30,15
		0.25-0.4	0.33A	13230003	MT-12 0.33A 3K	37,72
		0.4-0.63	0.52A	13230004	MT-12 0.52A 3K	37,72
		0.63-1	0.82A	13230005	MT-12 0.82A 3K	37,72
		1-1,6	1.3A	13230006	MT-12 1.3A 3K	37,72
		1.6-2.5	2.1A	13230007	MT-12 2.1A 3K	37,72
		2,5-4	3.3A	13230008	MT-12 3.3A 3K	37,72
		4-6	5A	13230009	MT-12 5A 3K	37,72
		5-8	6.5A	13230010	MT-12 6.5A 3K	37,72
		6-9	7.5A	13230011	MT-12 7.5A 3K	37,72
		7-10	8.5A	13230012	MT-12 8.5A 3K	37,72
9-13	11A	13230013	MT-12 11A 3K	37,72		
12-18	15A	13230027	MT-12 15A 3K	37,72		
MT-32	MC-9b/ MC-12b/ MC-18b/ MC-22b/ MC-32a/ MC-40a	0.1-0.16	0.14A	12980001	MT-32 0.14A 3K	55,39
		0.16-0.25	0.21A	12980002	MT-32 0.21A 3K	55,39
		0.25-0.4	0.33A	12980003	MT-32 0.33A 3K	55,39
		0.4-0.63	0.52A	12980004	MT-32 0.52A 3K	55,39
		0.63-1	0.82A	12980005	MT-32 0.82A 3K	55,39
		1-1,6	1.3A	12980006	MT-32 1.3A 3K	55,39
		1.6-2.5	2.1A	12980007	MT-32 2.1A 3K	55,39
		2,5-4	3.3A	12980008	MT-32 3.3A 3K	55,39
		4-6	5A	12980009	MT-32 5A 3K	55,39
		5-8	6.5A	12980010	MT-32 6.5A 3K	55,39
		6-9	7.5A	12980011	MT-32 7.5A 3K	55,39
		7-10	8.5A	12980012	MT-32 8.5A 3K	55,39
		9-13	11A	12980013	MT-32 11A 3K	55,39
		12-18	15A	12980014	MT-32 15A 3K	55,39
		16-22	19A	12980015	MT-32 19A 3K	55,39
		18-25	21.5A	12980016	MT-32 21.5A 3K	55,39
22-32	27A	12980017	MT-32 27A 3K	52,80		
28-40	34A	12980020	MT-32 34A 3K	52,80		
MT-63	MC-50a-MC-65a	18-25	21,5	13100008	MT-63 21.5A 3K	85,17
		24-36	30	13100009	MT-63 30A 3K	85,17
		28-40	34	13100010	MT-63 34A 3K	85,17
		34-50	42	13100011	MT-63 42A 3K	85,17
		45-65	54	13100012	MT-63 55A 3K	85,17
MT-95	MC75a/ MC-85a/ MC-100a	54-75	65	13140010	MT-95 65A 3K	133,32
		63-85	74	13140011	MT-95 74A 3K	133,32
		70-95	83	13140012	MT-95 83A 3K	133,32
		80-100	90	13140013	MT-95 90A 3K	133,32
MT-150	MC-130a/ MC-150a	80-105	93	13750019	MT-150 93A 3K	203,63
		95-130	113	13750020	MT-150 113A 3K	203,63
		110-150	130	13750021	MT-150 130A 3K	203,63
MT-225	MC-185a/ MC-225a	120-185	153	13770014	MT-225 153A 3K	296,22
		160-240	200	13770015	MT-225 200A 3K	296,22
MT-400	MC-265a / MC-330a / MC-400a	200-330	265	13780017	MT-400 265A 3K	473,97
		260-400	350	13780018	MT-400 350A 3K	473,97
MT-800	MC-500a / MC-630a / MC-800a	400-600	515	13790011	MT-800 515A 3K	1044,17
		520-800	660	13790012	MT-800 660A 3K	1044,17

Raya Montaj Adaptörleri (termik röleler için)



Model	Birlikte Kullanılacağı Kontaktör	Sipariş Kodu	Açıklama	Liste Fiyatı(\$)
UZ-32/S	MT-32 Screw	83661831001	MONTAJ ÜNİTESİ UZ-32/MT-32	8,92
UZ-63/S	MT-63 Screw	83661832002	MONTAJ ÜNİTESİ UZ-63/MT-63	11,15
UZ-95/S	MT-95 Screw	83661833002	MONTAJ ÜNİTESİ UZ-95/MT-95	14,07
UZ-150/S	MT-150 Screw	83661835002	MONTAJ ÜNİTESİ UZ-150/MT-150	23,35

Mini Kontaktörler

3 Kutup Güç Kontaktörleri (Bobin devresi AC)



Model	380/400V Güç (kW)	Termik Akımı (A) AC3	Termik Akımı (A) AC1	Yardımcı Kontak	Sipariş Kodu	Açıklama	Liste Fiyatı(\$)
GMC-6M	3kW	6A	20A	1NA	12690228	AC24V 50/60HZ 1a	21,81
				1NA	12690237	AC220V 50/60HZ 1a	21,81
				1NK	12690021	AC24V 50/60HZ 1b	21,81
				1NK	12690030	AC220V 50/60HZ 1b	21,81
GMC-9M	4kW	9A	20A	1NA	12690081	AC24V 50/60HZ 1a	23,24
				1NA	12690090	AC220V 50/60HZ 1a	23,24
				1NK	12690101	AC24V 50/60HZ 1b	23,24
				1NK	12690110	AC220V 50/60HZ 1b	23,24
GMC-12M	5,5kW	12A	20A	1NA	12690167	AC24V 50/60HZ 1a	25,00
				1NA	12690176	AC220V 50/60HZ 1a	25,00
				1NK	12690188	AC24V 50/60HZ 1b	25,00
				1NK	12690197	AC220V 50/60HZ 1b	25,00
GMC-16M	7,5kW	16A	20A	1NA	12690268	AC24V 50/60HZ 1a	27,16
				1NA	12690277	AC220V 50/60HZ 1a	27,16
				1NK	12690288	AC24V 50/60HZ 1b	27,16
				1NK	12690297	AC220V 50/60HZ 1b	27,16

3 Kutup Güç Kontaktörleri (Bobin devresi DC)



Model	380/400V Güç (kW)	Termik Akımı (A) AC3	Termik Akımı (A) AC1	Yardımcı Kontak	Sipariş Kodu	Açıklama	Liste Fiyatı(\$)
GMD-6M	3kW	6A	20A	1NA	12700031	DC24V 3W 1a	26,77
				1NK	12700059	DC24V 3W 1b	26,77
GMD-9M	4kW	9A	20A	1NA	12700143	DC24V 3W 1a	29,60
				1NK	12700174	DC24V 3W 1b	29,60
GMD-12M	5,5kW	12A	20A	1NA	12700258	DC24V 3W 1a	32,11
				1NK	12700286	DC24V 3W 1b	32,11
GMD-16M	7,5kW	16A	20A	1NA	12700371	DC24V 3W 1a	35,65
				1NK	12700399	DC24V 3W 1b	35,65

Yardımcı Kontaktörler (GMR-4)

Model	Kontak Sayısı	Çalışma Gerilimi	Yardımcı Kontak	Sipariş Kodu	Açıklama	Liste Fiyatı(\$)
GMR-4	4	DC 24V	4 NK	12740001	GMR-4MD DC24V 3W 4a	25,00
			3 NK - 1 NA	12740003	GMR-4MD DC24V 3W 3a1b	25,00
			2 NK - 2 NA	12740005	GMR-4MD DC24V 3W 2a2b	25,00
			4 NK	12740031	GMR-4MD DC110V 3W 4a	25,00
			3 NK - 1 NA	12740032	GMR-4MD DC110V 3W 3a1b	25,00
			2 NK - 2 NA	12740033	GMR-4MD DC110V 3W 2a2b	25,00
		AC 24V	4 NK	12730035	GMR-4M AC24V 50/60Hz 4a	25,00
			3 NK - 1 NA	12730036	GMR-4M AC24V 50/60Hz 3a1b	25,00
			2 NK - 2 NA	12730037	GMR-4M AC24V 50/60Hz 2a2b	25,00
			4 NK	12730017	GMR-4M AC220V 50/60Hz 4a	25,00
			3 NK - 1 NA	12730018	GMR-4M AC220V 50/60Hz 3a1b	25,00
			2 NK - 2 NA	12730019	GMR-4M AC220V 50/60Hz 2a2b	25,00
		AC 110V	4 NK	12730011	GMR-4M AC110V 50/60Hz 4a	25,00
			3 NK - 1 NA	12730007	GMR-4M AC110V 50/60Hz 3a1b	25,00
			2 NK - 2 NA	12730032	GMR-4M AC110V 50/60Hz 2a2b	25,00

Yardımcı Kontaktörler



Model	Kontak Sayısı	Not	Kontak	Sipariş Kodu	Açıklama	Liste Fiyatı(\$)	
AU-1M 10	1P	Yanına Takılan	1NO	83361621001	Yardımcı kontak ünitesi	AU-1M, 1A,	7,42
AU-1M 01			1NC	83361621002		AU-1M, 1B,	7,42
AU-2M 20	2P	Yanına Takılan	2NO	83361621008		AU-2M, 2A,	9,30
AU-2M 11			1NO + 1NC	83361621009		AU-2M, 1A, 1B,	9,30
AU-4M 40	4P	Üzerine Takılan	4NO	83361621003		AU-4M, 4A,	12,22
AU-4M 31			3NO + 1NC	83361621004		AU-4M, 3A1B,	12,22
AU-4M 22,			2NO + 2NC	83361621005		AU-4M, 2A2B,	12,22
AU-4M 13			1NO + 3NC	83361621006		AU-4M, 1A3B,	12,22
AU-4M 04			4NC	83361621007	AU-4M, 4B,	12,22	

Varistörler



Model	Kullanıldığı Kontaktör Tipi	Sipariş Kodu	Açıklama	Liste Fiyatı(\$)
AS-12M/1	GMC-6M-16M	83611621001	VARİSTÖR,AS-12M/1,AC24-48V	12,70
AS-12M/3		83611621003	VARİSTÖR,AS-12M/3,AC200-240V	12,70
AS-12M/4	GMD-6M-16M	83611621004	VARİSTÖR,AS-12M/4,DC12-24V	12,70
AS-12M/7		83611621007	VARİSTÖR,AS-12M/7,AC/DC200-250V	12,70

Zaman Röleleri



Model		Birlikte Kullanılacağı Kontaktör	Çalışma Gerilimi	Sipariş Kodu	Açıklama	Liste Fiyatı(\$)
AT-12/IN	Çekmede	"GMC-6M~16M GMD-6M~16M"	AC/DC 24-48V	83391621001	Zaman rölesi 0.1-30 saniye ayar sahası	158,94
AT-12/2IN	Gecikmeli		AC 110-220V	83391621002		158,94
AT-12/IF	Düşmede		AC/DC 24-48V	83391621003		158,94
AT-12/2F	Gecikmeli		AC 110-220V	83391621004		158,94

Mekanik Kilit Üniteleri



Model	Not	Sipariş Kodu	Açıklama	Liste Fiyatı(\$)
AR-12M	MEKANİK KİLİT ünitesi	83411621001	AR-12M(SEPERATE),GMC(D)-6-16MR	5,56
AR-12MW	MEKANİK KİLİT ünitesi	83411621007	AR-12MW(SEPERATE),GMC(D)-6-16MR	8,94

Termik Röleler



Model	Kutup	Termik Ayar Sahası	Birlikte Kullanılacağı Kontaktör	Sipariş Kodu	Açıklama	Liste Fiyatı(\$)
GTK-12M	3P	0.1~0.16A	GMC / GMD 6,9,12,16 M	12710029	GTK-12M 0.14A 3H	28,59
		0.16~0.25A		12710030	GTK-12M 0.21A 3H	28,59
		0.25~0.4A		12710031	GTK-12M 0.33A 3H	28,59
		0.4~0.63A		12710032	GTK-12M 0.52A 3H	28,59
		0.63~1.0A		12710033	GTK-12M 0.82A 3H	28,59
		1.0~1.6A		12710034	GTK-12M 1.3A 3H	28,59
		1.6~2.5A		12710035	GTK-12M 2.1A 3H	28,59
		2.5~4A		12710036	GTK-12M 3.3A 3H	28,59
		4~6A		12710037	GTK-12M 5A 3H	28,59
		5~8A		12710038	GTK-12M 6.5A 3H	28,59
		6~9A		12710039	GTK-12M 7.5A 3H	28,59
		7~10A		12710040	GTK-12M 8.5A 3H	28,59
		9~13A		12710041	GTK-12M 11A 3H	28,59
		12~16A		12710042	GTK-12M 14A 3H	28,59

Raya Montaj Adaptörü



Model	Birlikte kullanılacağı kontaktör	Sipariş Kodu	Açıklama	Liste Fiyatı(\$)
AZ-12H	GTK-12M	83661821002	Raya montaj adaptörü AZ-12H	14,07

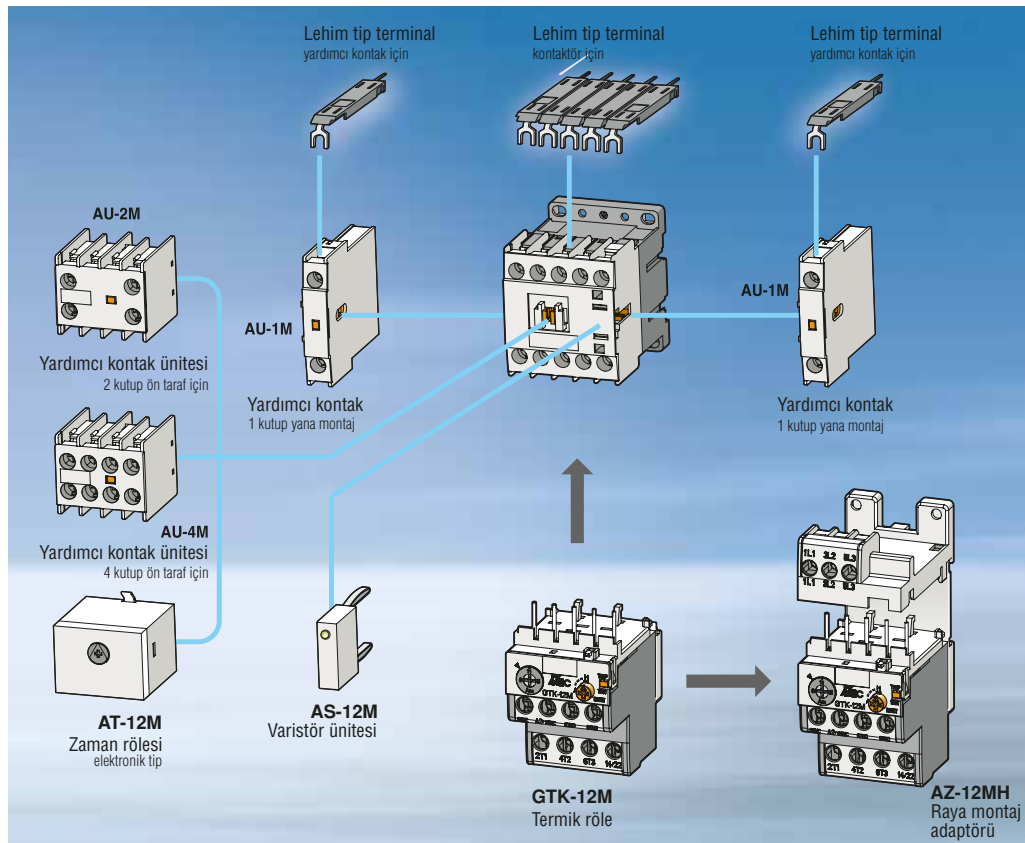

Top 100
Global
Innovator
for 10 years

Metasol *Meta Solution*

Motor Koruma Şalteri



LS ELECTRIC

MMS Serisi Motor Koruma Şalterleri (Standart Kesme Kapasitesi)

Model	Anma Gücü (kW) AC-3 400 V	Anma Akımı (A)	Termik Ayar Sahası (A)	Kesme Kapasitesi Icu (kA) 400 V	Sipariş Kodu	Açıklama	Liste Fiyatı(\$)
	0,16	0,16	0.1~0.16	100	07050033	MMS-32S 0.16A	55,35
	0,06	0,25	0.16~0.25	100	07050034	MMS-32S 0.25A	55,35
	0,09	0,4	0.25~0.4	100	07050035	MMS-32S 0.4A	55,35
	0,12	0,63	0.4~0.63	100	07050036	MMS-32S 0.63A	55,35
	0,25	1	0.63~1	100	07050037	MMS-32S 1A	55,35
	0,55	1,6	1~1.6	100	07050038	MMS-32S 1.6A	55,35
	0,75	2,5	1.6~2.5	100	07050039	MMS-32S 2.5A	55,35
	1,5	4	2.5~4	100	07050040	MMS-32S 4A	55,35
	2,2	6	4~6	100	07050041	MMS-32S 6A	55,35
	3	8	5~8	100	07050042	MMS-32S 8A	55,35
	4	10	6~10	50	07050043	MMS-32S 10A	55,35
	5,5	13	9~13	50	07050044	MMS-32S 13A	57,23
	7,5	17	11~17	20	07050045	MMS-32S 17A	57,23
	7,5	22	14~22	15	07050046	MMS-32S 22A	57,23
	11	26	18~26	15	07050047	MMS-32S 26A	57,23
15	32	22~32	15	07050048	MMS-32S 32A	57,23	
18,5	40	28~40	10	07050089	MMS-32S 40A	57,23	
	22	50	34~50	25	07060008	MMS-63S 50A	147,02
	30	63	45~63	25	07060009	MMS-63S 63A	147,02
	37	75	55~75	50	07070008	MMS-100S 75A	265,86
	45	90	70~90	50	07070009	MMS-100S 90A	287,77
	45	100	80~100	50	07070010	MMS-100S 100A	287,77

MMS-H/HI Serisi Motor Koruma Şalterleri (Yüksek Kesme Kapasitesi)

Model	Anma Gücü (kW) AC-3 400 V	Anma Akımı (A)	Termik Ayar Sahası (A)	Kesme Kapasitesi Icu (kA) 400 V	Sipariş Kodu	Açıklama	Liste Fiyatı(\$)
	4	10	6~10	100	07050011	MMS-32H 10A	65,65
	5,5	13	9~13	100	07050012	MMS-32H 13A	70,96
	7,5	17	11~17	50	07050013	MMS-32H 17A	70,96
	7,5	22	14~22	50	07050014	MMS-32H 22A	70,96
	11	26	18~26	50	07050015	MMS-32H 26A	70,96
	15	32	22~32	50	07050016	MMS-32H 32A	70,96
	18,5	40	28~40	50	07060016	MMS-63H 40A	162,62
	22	50	34~50	50	07060017	MMS-63H 50A	168,88
	30	63	45~63	50	07060018	MMS-63H 63A	168,88
	37	75	55~75	75	07070018	MMS-100H 75A	303,39
	45	90	70~90	75	07070019	MMS-100H 90A	322,22
	45	100	80~100	75	07070020	MMS-100H 100A	322,22

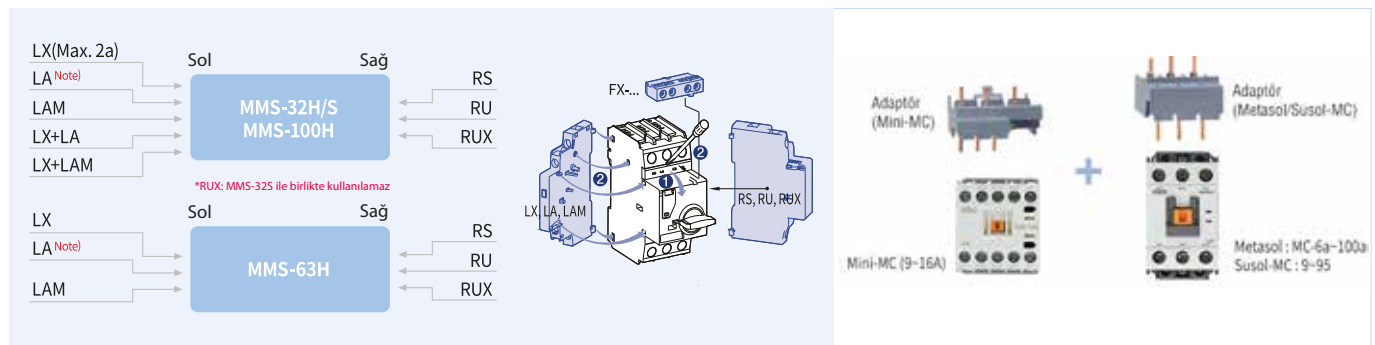

Koruma Kutusu

MMS koruma kutusu toz ve patlayıcı ortamlarda kullanılmak üzere koruyucu özellikli olarak tasarlanmıştır. Çimento ve pamuk fabrikaları gibi toz yoğun, ya da rafineri gübre ve kaplama tesisleri gibi yanıcı ve patlayıcı gazların bulunduğu ortamlarda optimum çözümler sunar.

Uygulanabilen Model : MMS-32
İşletme Sıcaklığı : -20 ~ + 60 OC
Koruma Sınıfı : IP65
Yalıtım Malzemesi : Plastik (ABS)
Sertifikalar : CE, UL

Tip	Ölçü	Sipariş Kodu	Açıklama	Liste Fiyatı(\$)
Koruma Kutusu	EPH32-65S	53911941001	KORUMA KUTUSU,EPH32-65S,	30,46

Motor Koruma Şalteri

Yardımcı Donanımlar

Yardımcı ve Alarm Kontakları



Tip	Montaj Şekli	Yardımcı Kontak	Sipariş Kodu	Açıklama	Liste Fiyatı(\$)	
FX 20	Üste Takılabilen	2NA	83361941111	YARDIMCI KONTAK	FX,2NA	9,94
FX11		1NA1NK	83361941112		FX,1NA1NK	9,94
FX02		2NK	83361941113		FX,2NK	9,94
LX20	Yana Takılabilen	2NA	83361941114	YARDIMCI KONTAK	LX,2NA	15,41
LX11		1NA1NK	83361941115		LX,1NA1NK	15,41
LX02		2NK	83361941116		LX,2NK	15,41
LA20	Alarm Kontaklı Tüm Arızalar	2NA	83011941001	ALARM KONTAĞI	LA,2NA	20,00
LA11		1NA1NK	83011941112		LA,1NA1NK	20,00
LA02		2NK	83011941113		LA,2NK	20,00
LAM20	Alarm Kontaklı Manyetik Arızalar	2NA	83011941114	ALARM KONTAĞI	LAM,2NA	21,21
LAM11		1NA1NK	83011941115		LAM,1NA1NK	21,21
LAM02		2NK	83011941116		LAM,2NK	21,21

Açtırma ve Düşük Gerilim Bobinleri



Tip	Tanım	Sipariş Kodu	Açıklama	Liste Fiyatı(\$)
RS230	Açtırma Bobini	70911941113	SHUNT,RS,AC220V~230V 50Hz/AC240V~260V 60Hz,	33,54
RS400		70911941115	SHUNT,RS,AC380V~400V 50Hz/AC440V~460V 60Hz,	33,54
RU230	Düşük Gerilim Bobini	83211941113	T,UVT,RU,AC220V~230V 50Hz/AC240V~260V 60Hz,	33,54
RU400		83211941115	T,UVT,RU,AC380V~400V 50Hz/AC440V~460V 60Hz,	33,54
RUX230	Düşük Gerilim Açtırma Bobini + Alarm Switch	83211941133	T,UVT,RUX,AC220V~230V 50Hz/AC240V~260V 60Hz,	38,13
RUX400		83211941135	T,UVT,RUX,AC380V~400V 50Hz/AC440V~460V 60Hz,	38,13

Kurma Kolları



Tip	Ölçü	Sipariş Kodu	Açıklama	Liste Fiyatı(\$)	
MEH-32	115 mm	83111912111	KURMA KOLU	MEH32,115	36,92
MEH-32	315 mm	83111912114		MEH32,315	39,94
MEH-63	115 mm	83111912112		MEH63,115	36,92
MEH-64	315 mm	83111912115		MEH63,315	39,94
MEH-100	115 mm	83111912113		MEH100,115	36,92
MEH-100	315 mm	83111912116		MEH100,315	39,94

Besleme Baraları



Tip	Kullanılacağı Ürün	Sipariş Kodu	Açıklama	Liste Fiyatı(\$)
PB-322	MMS-32S/H	70211941111	PB-322 BESLEME BARASI 2 AD. MMS İÇİN 63A	10,76
PB-632	MMS-63S/H	70211941121	PB-632 BESLEME BARASI 2 AD. MMS İÇİN 108A	21,21
PBL-322	MMS-32S/H	70211941115	PBL-322 BESLEME BARASI 2 AD. MMS İÇİN 63A	25,55
PB-323	MMS-32S/H	70211941112	PB-323 BESLEME BARASI 3 AD. MMS İÇİN 63A	27,68
PB-633	MMS-63S/H	70211941122	PB-633 BESLEME BARASI 3 AD. MMS İÇİN 108A	30,46
PBL-323	MMS-32S/H	70211941116	PBL-323 BESLEME BARASI 3 AD. MMS İÇİN 63A	28,03
PB-324	MMS-32S/H	70211941113	PB-324 BESLEME BARASI 4 AD. MMS İÇİN 63A	23,69
PB-325	MMS-32S/H	70211941114	PB-325 BESLEME BARASI 5 AD. MMS İÇİN 63A	27,57
LTB-32	MMS-32S/H	62671941111	LTB-32 BESLEME BARASI GİRİŞİ	7,61

Direk Bağlantı Montaj Üniteleri

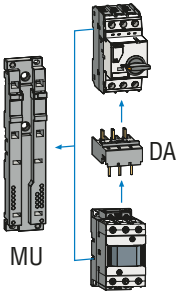

Tip	Ölçü	Sipariş Kodu	Açıklama	Liste Fiyatı(\$)	
MU-45	genişlik 45mm	83661941111	MONTAJ ÜNİTESİ	MU-45	10,76
MU-55	genişlik 55mm	83661941112		MU-55	20,00
MU-70	genişlik 70mm	83661941113		MU-70	23,08

Kontaktör MMS Adaptörleri

Adaptör	Birleştirdiği Ürünler	Sipariş Kodu	Berber Kullanılan Montaj Ünitesi Tipi	Açıklama	Liste Fiyatı(\$)
DA-16SA	MMS-32S + GMC-6M~16M	13311941111	MU45	AC,DA-16SA,	7,28
DA-16SD	MMS-32S + GMD-6M~16M	13311941112		AC,DA-16SD,	7,28
DA-16HA	MMS-32H + GMC-6M~16M	13311941113		AC,DA-16HA,	7,28
DA-16HD	MMS-32H + GMD-6M~16M	13311941114		AC,DA-16HD,	7,28
DA-18SA	MMS-32S + MC-6a~18a AC	73311634131		AC,DA-18SA,	10,40
DA-18SD	MMS-32S + MC-6a~18a DC	73311634133		DC,DA-18SD,	10,40
DA-18HA	MMS-32H/HI + MC-6a~18a AC	73311634132		AC,DA-18HA,	10,40
DA-18HD	MMS-32H/HI + MC-6a~18a DC	73311634134		DC,DA-18HD,	10,40
DA-22SA	MMS-32S + MC-9b~22b AC	73311634135		AC,DA-22SA	11,17
DA-22SD	MMS-32S + MC-9b~22b DC	73311634137		AC,DA-22SD	11,17
DA-22HA	MMS-32H/HI + MC-9b~22b AC	73311634136		AC,DA-22HA	11,17
DA-22HD	MMS-32H/HI + MC-9b~22b DC	73311634138		AC,DA-22HD	11,17
DA-32SA	MMS-32S + MC-32a,40a AC	73311634121	MU55	AC,DA-32SA	14,09
DA-32SD	MMS-32S + MC-32a,40a DC	73311634123		DC,DA-32SD	14,09
DA-32HA	MMS-32H/HI + MC-32a,40a AC	73311634122		AC,DA-32HA	14,09
DA-32HD	MMS-32H/HI + MC-32a,40a DC	73311634124		DC,DA-32HD	14,09
DA-63A	MMS-63S/H/HI + MC-50a,65a AC LUG	73311634125		AC,DA-63A	16,72
DA-63D	MMS-63S/H/HI + MC-50a,65a DC LUG	73311634126		DC,DA-63D	16,72
DA-95A	MMS-100S/H/HI + MC-75a~100a AC LUG	73311634127	MU70	AC,DA-95A	22,22
DA-95D	MMS-100S/H/HI + MC-75a~100a DC LUG	73311634128		DC,DA-95D	22,22

GMP Serisi

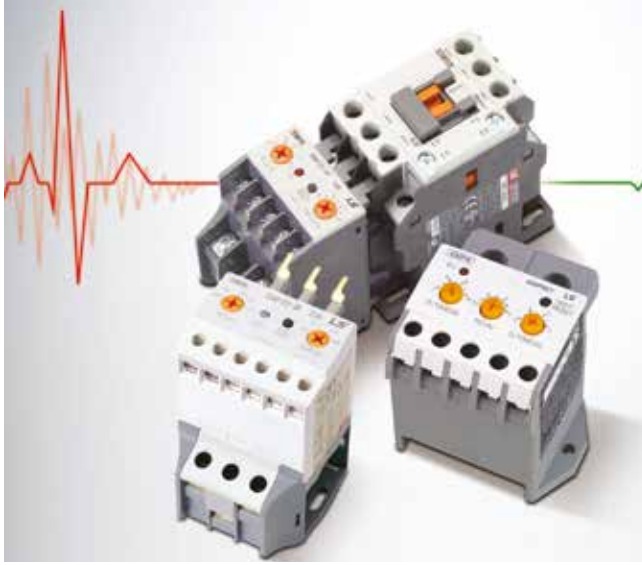

Koruma Fonksiyonları

1. Aşırı Akım
2. Motor Kilit
3. Faz Hatası
4. Faz Dengesizliği
5. Ters Faz
6. Düşük Akım
7. Toprak Hatası

Seçmiş olduğunuz ürünün ihtiyacınız olan koruma fonksiyonunu desteklediğini ilgili kataloğundan kontrol ediniz.

Sipariş Kodu Oluşturma

Çerçeve	Nominal Akım	Tip	CT Tipi	Ters Faz	Nominal Akım	Akım Ayar Aralığı (A)	Besleme Voltajı	Harici Kontakt	Model
22	1.5A	Direk Bağlantı	2 2CT	- Ters Koruma Mevcut Değil	1.5A	0.3~1.5	110/220 AC100~260V	1c(N)	Vida Tip
	5A	Terminal Bağlantı	3 3CT	R Ters Koruma Mevcut	5A	1~5	24 AC24V	1c(R)	Tünel Tip
	22A		22A		4.4~22	48 AC48V	1a1b	Sol Metasol Direk Bağlantı (Pin)	
40	20A	Penetrasyon	Tip	A Otomatik Kurtarma	20A	4~20	110 AC110V		1a1b
	40A				P Pin Tip	40A	8~40	220 AC220V	
80	80A	Terminal Bağlantı	S Vida Tip	Sınıflandırma	80A	16~80	380 AC380 (440)V	1a1b	Sol Metasol Direk Bağlantı (Pin)
	06A		T Tünel Tip		06A	0.5~6	480 AC180~480V		
60	30A	Penetrasyon	TE Ekonomik	- Varolan Model	30A	3~30	Not: AC24V, AC48V, AC380/440V ve AC480V, GMP60T modelidir.	1a1b	Sol Metasol Direk Bağlantı (Pin)
	60A		PD Direk Bağlantı	a Operasyon Zaman Fonksiyon	60A	0.5~60 ^{not}			
			TD Güncel Ekran						
			TZ Toprak Arıza Koruması Sıfır-Faz Sırası Akım Algılama						
			TN Toprak Arıza Koruması Kaçak Akım Algılama						

GMP Serisi Zaman Ayarlı Röleler

Model	Özellikler	Ayar Sahası(A)	Yardımcı Kontakt	Sipariş Kodu	Açıklama	Liste Fiyatı(\$)
GMP22-3SR-1,5	Aşırı Akım	0.3~1.5	1NA + 1NK	3802003100	GMP22-3SR 1.5A 110/220V 1a1b	117,85
GMP22-3SR-5		1~5		3802003200	GMP22-3SR 5A 110/220V 1a1b	117,85
GMP22-3SR-22	Kilitli Rotor	4.4~22		3802003300	GMP22-3SR 22A 110/220V 1a1b	117,85
GMP40-3SR-20	Faz Dengesi	4~20		3804001900	GMP40-3SR 20A 110/220V 1a1b	117,85
GMP40-3SR-40	Ters Faz	8~40		3804002000	GMP40-3SR 40A 110/220V 1a1b	117,85
GMP40-3SR-80		16~80		3805000500	GMP80-3SR 80A 110/220V 1a1b	141,46

Fiyat listesinde yer almayan ürünlerimiz ile ilgili bilgi almak için yetkili satış kanallarımız ile temasa geçebilirsiniz.

Metasol *Meta Solution*

MCCB/ELCB

Alçak Gerilim Kompakt Tip Koruma Şalterleri

Alçak Gerilim Kaçak Akım Korumalı Kompakt Tip Koruma Şalterleri



Termik ve Manyetik Koruma Ayarı Gerekmeyen Uygulamalar için
Ekonomik Çözümler (18kA-65kA, 16A-800A)

Sadece Termik Koruma Ayarı Gereken Uygulamalar için
Ekonomik Çözümler (37kA, 25A-250A)



Susol Super Solution

MCCB

Alçak Gerilim Kompakt Tip Koruma Şalterleri

- **Super** Performans
- **Super** Kesme Kapasitesi
- **Super** Optimum Koordinasyon
- **Super** Kapsamlı Uygulamalar



Metasol Serisi Kompakt Tip Şalterler

3 Kutuplu Termik Sabit / Manyetik Sabit Tip Kompakt Şalterler (Ics=%100Icu)

Model	Anma Akımı (A)	Termik Ayar akımı (A)	Manyetik Ayar akımı (A)	Kesme Kapasitesi Icu (kA)	Sipariş Kodu	Açıklama	Liste Fiyatı(\$)
100AF	16A	Sabit	Sabit (400A)	18kA	01310077	ABN103c 16A	95,56
	20A				01310078	ABN103c 20A	95,56
	30A				01310079	ABN103c 30A	95,56
	40A	Sabit	Sabit (12In)	18kA	01310080	ABN103c 40A	95,56
	50A				01310081	ABN103c 50A	95,56
	60A				01310082	ABN103c 60A	95,56
	75A				01310083	ABN103c 75A	95,56
	100A				01310084	ABN103c 100A	95,56
250AF	125A	Sabit	Sabit (12In)	25kA	01370054	ABN203c 125A	187,09
	150A				01370055	ABN203c 150A	187,09
	175A				01370056	ABN203c 175A	187,09
	200A				01370057	ABN203c 200A	187,09
	225A				01370058	ABN203c 225A	187,09
	250A				01370059	ABN203c 250A	193,09
	125AF				16A	Sabit	Sabit (400A)
20A		01340002	ABS103c 20A	132,23			
30A		01340003	ABS103c 30A	132,23			
40A		Sabit	Sabit (12In)	37kA	01340004	ABS103c 40A	132,23
50A					01340005	ABS103c 50A	132,23
60A					01340006	ABS103c 60A	132,23
75A					01340007	ABS103c 75A	132,23
100A					01340008	ABS103c 100A	132,23
125A					01340009	ABS103c 125A	132,23
250AF					150A	Sabit	Sabit (12In)
	175A	01370004	ABS203c 175A	213,21			
	200A	01370005	ABS203c 200A	213,21			
	225A	01370006	ABS203c 225A	213,21			
	250A	01370007	ABS203c 250A	219,57			
400AF	300A	Sabit	8-12In	37kA	01640006	ABN403c 300A	475,19
	350A				01640007	ABN403c 350A	475,19
	400A				01640008	ABN403c 400A	475,19
800AF	500A	Sabit	8-12In	37kA	01660023	ABN803c 500A	873,32
	630A				01660024	ABN803c 630A	873,32
	700A				01660003	ABN803c 700A	983,82
	800A				01660004	ABN803c 800A	983,82
50AF	15A	Sabit	Sabit (12In)	50kA	01340010	ABH53c 15A	107,11
	20A				01340011	ABH53c 20A	107,11
	30A				01340012	ABH53c 30A	107,11
	40A				01340013	ABH53c 40A	107,11
	50A				01340014	ABH53c 50A	107,11
125AF	60A	Sabit	Sabit (12In)	50kA	01340020	ABH103c 60A	161,97
	75A				01340021	ABH103c 75A	161,97
	100A				01340022	ABH103c 100A	161,97
	125A				01340023	ABH103c 125A	175,03
250AF	150A	Sabit	Sabit (12In)	50kA	01400003	ABH203c 150A	242,95
	175A				01400004	ABH203c 175A	242,95
	200A				01400005	ABH203c 200A	242,95
	225A				01400006	ABH203c 225A	242,95
	250A				01400007	ABH203c 250A	261,24
400AF	300A	Sabit	8-12In	50kA	01640018	ABS403c 300A	526,57
	350A				01640019	ABS403c 350A	526,57
	400A				01640020	ABS403c 400A	526,57
	500A				01660029	ABS803c 500A	968,33
800AF	630A	Sabit	8-12In	65kA	01660034	ABS803c 630A	968,33
	700A				01660009	ABS803c 700A	1.027,44
	800A				01660010	ABS803c 800A	1.027,44

4 Kutuplu Termik Sabit / Manyetik Sabit Tip Kompakt Şalterler (Ics=%100Icu)

Model	Anma Akımı (A)	Termik Ayar akımı (A)	Manyetik Ayar akımı (A)	Kesme Kapasitesi Icu (kA)	Sipariş Kodu	Açıklama	Liste Fiyatı(\$)
100AF	16A	Sabit	Sabit (400A)	18kA	01320059	ABN103c 16A	116,49
	20A				01320060	ABN103c 20A	116,49
	30A				01320061	ABN103c 30A	116,49
	40A				01320062	ABN103c 40A	116,49
	50A	Sabit	Sabit (12In)		01320063	ABN103c 50A	116,49
	60A				01320064	ABN103c 60A	116,49
	75A				01320065	ABN103c 75A	116,49
	100A				01320066	ABN103c 100A	116,49
250AF	125A	Sabit	Sabit (12In)	25kA	01380023	ABN203c 125A	216,94
	150A				01380024	ABN203c 150A	216,94
	175A				01380025	ABN203c 175A	216,94
	200A				01380026	ABN203c 200A	216,94
	225A				01380027	ABN203c 225A	216,94
	250A				01380028	ABN203c 250A	240,49
125AF	16A	Sabit	Sabit (400A)	37kA	01350001	ABS104c 15A	147,91
	20A				01350002	ABS104c 20A	147,91
	30A				01350003	ABS104c 30A	147,91
	40A	Sabit	Sabit (12In)		01350004	ABS104c 40A	147,91
	50A				01350005	ABS104c 50A	147,91
	60A				01350006	ABS104c 60A	147,91
	75A				01350007	ABS104c 75A	147,91
	100A				01350008	ABS104c 100A	147,91
	125A				01350009	ABS104c 125A	147,91
250AF	150A	Sabit	Sabit (12In)	37kA	01380003	ABS204c 150A	248,36
	175A				01380004	ABS204c 175A	248,36
	200A				01380005	ABS204c 200A	248,36
	225A				01380006	ABS204c 225A	248,36
	250A				01640007	ABS204c 250A	475,19
400AF	300A	Sabit	8-12In	37kA	01640010	ABN404c 300A	539,39
	350A				01640011	ABN404c 350A	539,39
	400A				01640012	ABN404c 400A	539,39
800AF	500A	Sabit	8-12In	37kA	01660025	ABN804c 500A	970,96
	630A				01660026	ABN804c 630A	970,96
	700A				01660005	ABN804c 700A	1.245,74
	800A				01660006	ABN804c 800A	1.245,74
50AF	15A	Sabit	Sabit (12In)	50kA	01350010	ABH54c 15A	135,85
	20A				01350011	ABH54c 20A	135,85
	30A				01350012	ABH54c 30A	135,85
	40A				01350013	ABH54c 40A	135,85
	50A				01350014	ABH54c 50A	135,85
125AF	60A	Sabit	Sabit (12In)	50kA	01350020	ABH104c 60A	188,09
	75A				01350021	ABH104c 75A	188,09
	100A				01350022	ABH104c 100A	188,09
	125A				01350023	ABH104c 125A	202,64
250AF	150A	Sabit	Sabit (12In)	50kA	01410003	ABH204c 150A	313,49
	175A				01410004	ABH204c 175A	347,46
	200A				01410005	ABH204c 200A	347,46
	225A				01410006	ABH204c 225A	347,46
	250A				01410007	ABH204c 250A	347,46
400AF	300A	Sabit	8-12In	50kA	01640022	ABS404c 300A	644,73
	350A				01640023	ABS404c 350A	644,73
	400A				01640024	ABS404c 400A	644,73
	500A				01660035	ABS804c 500A	1.207,26
800AF	630A	Sabit	8-12In	65kA	01660036	ABS804c 630A	1.207,26
	700A				01660011	ABS804c 700A	1.230,60
	800A				01660012	ABS804c 800A	1.230,60

Metasol Serisi Kaçak Akım Korumalı Kompakt Tip Şalterler

3 Kutuplu Kompakt Tip Toprak Kaçak Akım Koruma Şalterleri ($I_{\Delta n}=30mA$) ($I_{cs}=\%100I_{cu}$)

Model	Anma Akımı (A)	Termik Ayar akımı (A)	Manyetik Ayar akımı (A)	$I_{\Delta n}$	Kesme Kapasitesi ucu (kA)	Sipariş Kodu	Açıklama	Liste Fiyatı(\$)
125AF	20A	Sabit	Sabit (400A)	30mA	37kA	1440002	EBS103c 20A 30mA	325,51
	30A					1440003	EBS103c 30A 30mA	325,51
	40A					1440004	EBS103c 40A 30mA	325,51
	50A		1440005			EBS103c 50A 30mA	325,51	
	60A		1440006			EBS103c 60A 30mA	325,51	
	75A		1440007			EBS103c 75A 30mA	325,51	
	100A		1440008			EBS103c 100A 30mA	325,51	
	125A		1440009			EBS103c 125A 30mA	325,51	
	250AF		150A			Sabit	Sabit (12In)	30mA
175A		1450018	EBS203c 175A 30mA	698,80				
200A		1450019	EBS203c 200A 30mA	698,80				
225A		1450020	EBS203c 225A 30mA	719,34				
250A		1450021	EBS203c 250A 30mA	719,34				
250AF		250A	Sabit	Sabit (8-12In)	30mA			
300A	1670018	EBS403c 300A 30mA				1.146,40		
350A	1670019	EBS403c 350A 30mA				1.146,40		
400A	1670020	EBS403c 400A 30mA				1.146,40		
800AF	500A	Sabit	Sabit (8-12In)	30mA	65kA	1690017	EBS803c 500A 30mA	2.607,82
	630A					1690018	EBS803c 630A 30mA	2.607,82
	700A					1690005	EBS803c 700A 30mA	2.607,82
	800A					1690006	EBS803c 800A 30mA	2.607,82

3 Kutuplu Kompakt Tip Toprak Kaçak Akım Koruma Şalterleri ($I_{\Delta n}=100/200-300/500mA$) ($I_{cs}=\%100I_{cu}$)

Model	Anma Akımı (A)	Termik Ayar akımı (A)	Manyetik Ayar akımı (A)	$I_{\Delta n}$	Kesme Kapasitesi ucu (kA)	Sipariş Kodu	Açıklama	Liste Fiyatı(\$)
125AF	20A	Sabit	Sabit (400A)	100/300 500mA	37kA	1440519	EBS103c 20A 100/300/500mA	292,87
	30A					1440520	EBS103c 30A 100/300/500mA	292,87
	40A					1440521	EBS103c 40A 100/300/500mA	292,87
	50A		1440522			EBS103c 50A 100/300/500mA	292,87	
	60A		1440523			EBS103c 60A 100/300/500mA	292,87	
	75A		1440524			EBS103c 75A 100/300/500mA	292,87	
	100A		1440525			EBS103c 100A 100/300/500mA	292,87	
	125A		1440526			EBS103c 125A 100/300/500mA	295,94	
	250AF		150A			Sabit	Sabit (12In)	100/300 500mA
175A		1450341	EBS203c 175A 100/300/500mA	632,29				
200A		1450342	EBS203c 200A 100/300/500mA	637,68				
225A		1450343	EBS203c 225A 100/300/500mA	661,97				
250A		1450344	EBS203c 250A 100/300/500mA	678,29				
250AF		250A	Sabit	Sabit (8-12In)	100/200 500mA			
300A	1670022	EBS403c 300A 100/200/500mA				1.255,55		
350A	1670023	EBS403c 350A 100/200/500mA				1.255,55		
400A	1670024	EBS403c 400A 100/200/500mA				1.255,55		
800AF	500A	Sabit	Sabit (8-12In)	100/200 500mA	65kA	1690019	EBS803c 500A 100/200/500mA	2.483,60
	630A					1690020	EBS803c 630A 100/200/500mA	2.483,60
	700A					1690007	EBS803c 700A 100/200/500mA	2.483,60
	800A					1690008	EBS803c 800A 100/200/500mA	2.483,60

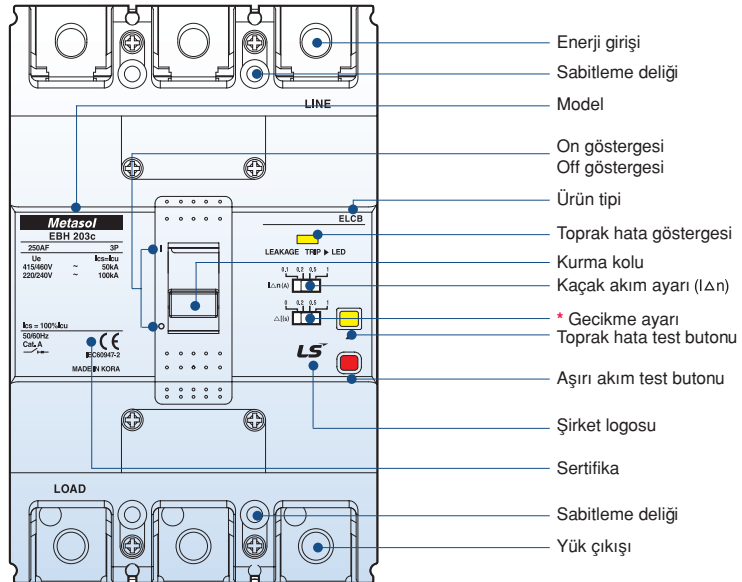

* Fiyat listesinde yer alan ürünlerde gecikme ayarı yoktur. Gecikme ayarı olan ürün talepleriniz için yetkili satış kanallarımızla temasa geçebilirsiniz.

4 Kutuplu Kompakt Tip Toprak Kaçak Akım Koruma Şalterleri ($I_{\Delta n}=30\text{mA}$) ($I_{cs}=\%100I_{cu}$)

Model	Anma Akımı (A)	Termik Ayar akımı (A)	Manyetik Ayar akımı (A)	$I_{\Delta n}$	Kesme Kapasitesi ucu (kA)	Sipariş Kodu	Açıklama	Liste Fiyatı(\$)
125AF	20A	Sabit	Sabit (400A)	30mA	37kA	01440048	EBS104c 20A 30mA	383,23
	30A					01440049	EBS104c 30A 30mA	383,23
	40A					01440050	EBS104c 40A 30mA	383,23
	50A					01440051	EBS104c 50A 30mA	383,23
	60A		Sabit (12In)			01440052	EBS104c 60A 30mA	383,23
	75A					01440053	EBS104c 75A 30mA	383,23
	100A					01440054	EBS104c 100A 30mA	383,23
	125A					01440055	EBS104c 125A 30mA	383,23
250AF	150A	Sabit	Sabit (12In)	30mA	37kA	01450045	EBS204c 150A 30mA	825,67
	175A					01450046	EBS204c 175A 30mA	825,67
	200A					01450047	EBS204c 200A 30mA	825,67
	225A					01450048	EBS204c 225A 30mA	849,98
	250A					01450049	EBS204c 250A 30mA	849,98
	400AF					250A	Sabit	Sabit (8-12In)
300A		01670026	EBS404c 300A 30mA	1.512,38				
350A		01670027	EBS404c 350A 30mA	1.512,38				
400A		01670028	EBS404c 400A 30mA	1.512,38				

4 Kutuplu Kompakt Tip Toprak Kaçak Akım Koruma Şalterleri ($I_{\Delta n}=100/200-300/500\text{mA}$) ($I_{cs}=\%100I_{cu}$)

Model	Anma Akımı (A)	Termik Ayar akımı (A)	Manyetik Ayar akımı (A)	$I_{\Delta n}$	Kesme Kapasitesi ucu (kA)	Sipariş Kodu	Açıklama	Liste Fiyatı(\$)
125AF	20A	Sabit	Sabit (400A)	100/300 500mA	37kA	01440542	EBS104c 20A 100/300/500mA	377,75
	30A					01440543	EBS104c 30A 100/300/500mA	377,75
	40A					01440544	EBS104c 40A 100/300/500mA	377,75
	50A					01440545	EBS104c 50A 100/300/500mA	377,75
	60A		Sabit (12In)			01440546	EBS104c 60A 100/300/500mA	377,75
	75A					01440547	EBS104c 75A 100/300/500mA	377,75
	100A					01440548	EBS104c 100A 100/300/500mA	377,75
	125A					01440549	EBS104c 125A 100/300/500mA	383,26
250AF	150A	Sabit	Sabit (12In)	100/300 500mA	37kA	01450347	EBS204c 150A 100/300/500mA	837,65
	175A					01450348	EBS204c 175A 100/300/500mA	837,65
	200A					01450349	EBS204c 300A 100/300/500mA	837,65
	225A					01450350	EBS204c 225A 100/300/500mA	862,31
	250A					01450351	EBS204c 250A 100/300/500mA	862,31
	400AF					250A	Sabit	Sabit (8-12In)
300A		01670030	EBS404c 300A 100/200/500mA	1.440,33				
350A		01670031	EBS404c 350A 100/200/500mA	1.440,33				
400A		01670032	EBS404c 400A 100/200/500mA	1.440,33				

Metasol ELCB							
AF Type	30AF	50AF	60AF	100AF	125AF	250AF	
EBS	EBS30c 14kA	EBS50c 18kA	EBS60c 18kA		EBS125c 37kA	EBS250c 37kA	
EBH		EBH50c 50kA			EBH125c 50kA	EBH250c 50kA	
AF Type	400AF	630AF	800AF				
EBS	EBS400c 50kA	EBS630c 65kA	EBS800c 65kA				
EBL	EBL400c 85kA	EBL630c 85kA	EBL800c 85kA				

Fiyat Listemizde yer almayan ürünlerimiz için Yetkili satış kanallarımız ile temasa geçebilirsiniz.

Yardımcı Donanımlar

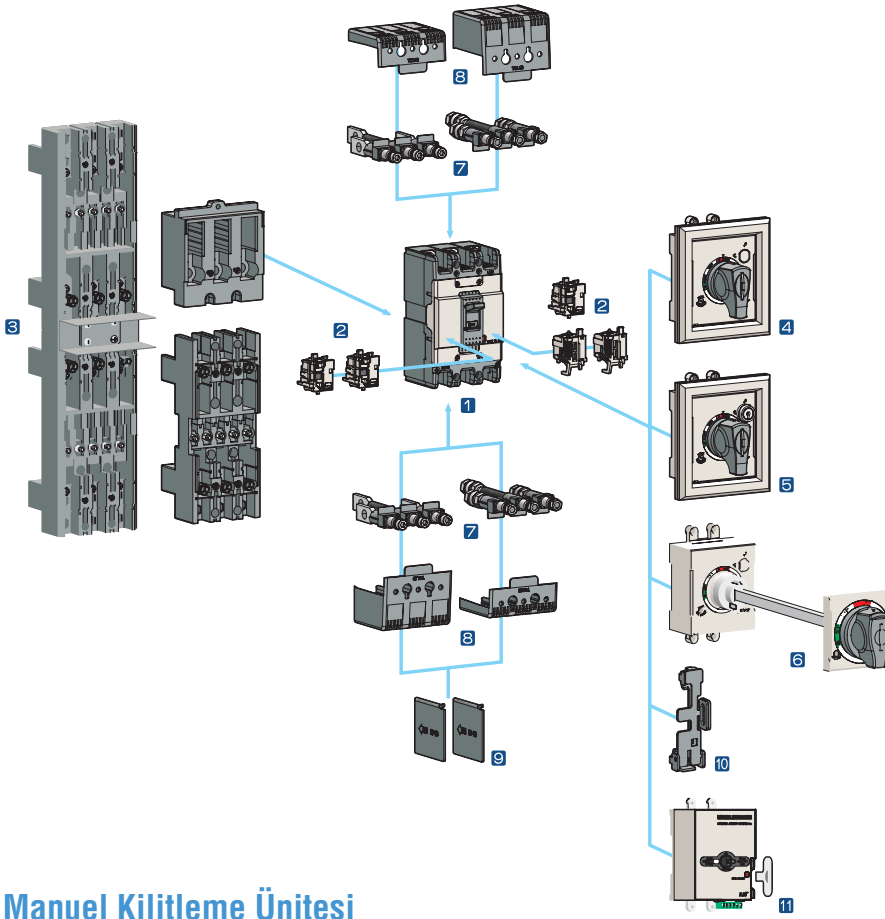

Genel görünüm

- 1 Şalter
- 2 Dahili yardımcı kontaklar
- 3 Plug-in ünitesi
- 4 Döner kurma kolu (direk)
- 5 Döner kurma kolu (direk, kilitli)
- 6 Döner kurma kolu (uzatmalı)
- 7 Geriye uzatma parçaları
- 8 Terminal kapağı (kısa, uzun)
- 9 İzolasyon bariyeri
- 10 Manuel kilitleme ünitesi
- 11 Motor mekanizması

Manuel Kilitleme Ünitesi

Model	Beraber kullanılan şalterler		Sipariş Kodu	Açıklama	Liste Fiyatı(\$)
	Şalter	Kaçak akım şalteri			
HL-100c	ABS30c,ABS/N50c,ABS/N60c,ABN100c	EBS30c,EBS/N50c,EBS/N60c,EBN100c	83421187001	HL-100c Manuel Kilitleme Ünitesi	78,26
HL-125c	ABN/S/H/L 125c,ABH50c	EBS/H125c, EBH50c	83421187002	HL-125c Manuel Kilitleme Ünitesi	78,26
HL-250c	ABN/S/H/L 250c	EBN/S/H250c	83421187003	HL-250c Manuel Kilitleme Ünitesi	78,26
HL-400c	ABN/S/H/L 400c,ABN/S/L800c	EBN/S/H/L400c,EBN/S/L800c	83421138001	HL-400c Manuel Kilitleme Ünitesi	78,26

Mekanik Kilitleme Ünitesi

Model	Beraber kullanılan şalterler		Sipariş Kodu	Açıklama	Liste Fiyatı(\$)
	Şalter	Kaçak akım şalteri			
MI-13	ABS30c,ABS/N50c,ABS/N60c,ABN100c	EBS30c,EBS/N50c,EBS/N60c,EBN100c	56121187001	MI-13 mekanik kilitleme ünitesi	65,33
MI-14			56121187002	MI-14 mekanik kilitleme ünitesi	65,33
MI-23	ABH50c, ABS/H/L125c	EBS125c,EBH50c,EBH125c	56121187003	MI-23 mekanik kilitleme ünitesi	66,01
MI-24			56121187004	MI-24 mekanik kilitleme ünitesi	66,01
MI-33	ABN/S/H/L250c	EBN/S/H250c	56121187005	MI-33 mekanik kilitleme ünitesi	67,53
MI-34			56121187006	MI-34 mekanik kilitleme ünitesi	67,53
MI-43	ABN/S/H/L400c	EBN/S/H/L400c	56121138005	MI-43 mekanik kilitleme ünitesi	95,41
MI-44			56121138007	MI-44 mekanik kilitleme ünitesi	95,41
MI-83	ABN/S/L800c	EBN/S/L800c	56121138006	MI-83 mekanik kilitleme ünitesi	107,65
MI-84			56121138008	MI-84 mekanik kilitleme ünitesi	107,65

Manuel Kilitleme Ünitesi

100AF/125AF/250AF Şalterler için

400AF/800AF Şalterler için

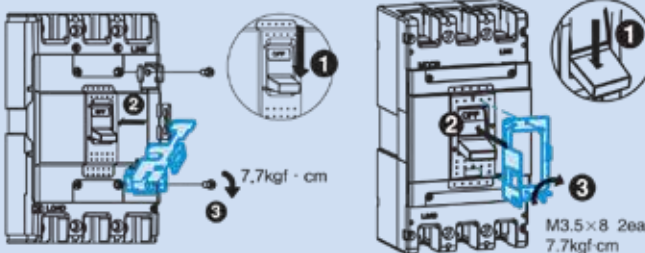

Mekanik Kilitleme Ünitesi

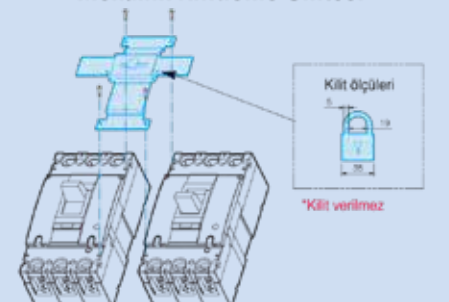

Motor Mekanizmaları

	Model	Kontrol Gerilimi	Birlikte Kullanılacak Şalter Boyutu		Sipariş Kodu	Açıklama	Liste Fiyatı(\$)
			3P	4P			
	MOP-M1	DC24V	100AF	100AF	83471187901	MOP-M1,DC24V	414,87
		AC230V/ DC220V			83471187903	MOP-M1,AC230V/DC220V	414,87
	MOP-M2	DC24V	125AF	125AF	83471187904	MOP-M2,DC24V	577,96
		AC230V/ DC220V			83471187906	MOP-M2,AC230V/DC220V	577,96
	MOP-M3	DC24V	250AF	250AF	83471187907	MOP-M3,DC24V	785,42
		AC230V/ DC220V			83471187909	MOP-M3,AC230V/DC220V	785,42
	MOP-M4	DC24V	400AF	400AF	83471184901	MOP-M4,DC24V	933,63
		AC230V/ DC220V			83471184903	MOP-M4,AC230V/DC220V	933,63
	MOP-M5	DC24V	800AF	800AF	83471185901	MOP-M5,DC24V	767,68
		AC230V/ DC220V			83471185903	MOP-M5,AC230V/DC220V	767,68

Yardımcı Kontaklar & Alarm Kontakları

	Model	Tanımı	Sipariş Kodu	Bağlantı Tipi	Birlikte Kullanılacak Şalter Boyutu	Liste Fiyatı(\$)
	AXRW	YARDIMCI KONTAK, SOL	83011187001	Terminal	"30AF ~ 250AF"	22,04
	ALRW	ALARM KONTAK, SOL	83011187002			22,04
	AX/AL RW	KOMBİNASYON KONTAK, SOL	83011187003			43,62
	AXTW	YARDIMCI KONTAK, SAĞ	83011187004			22,04
	ALTW	ALARM KONTAK, SAĞ	83011187005			22,04
	AX/AL TW	KOMBİNASYON KONTAK, SAĞ	83011187006			43,62
	AX1LWT	YARDIMCI KONTAK, 1NA+1NK	83011136002	Klemens	"400 ~ 800AF"	24,56
	AL1LWT	ALARM KONTAK, 1NA+1NK	83011136004			24,56
	AX1LWT	YARDIMCI KONTAK, 2NA+2NK	83011136003			24,56
	AL1LWT	ALARM KONTAK, 2NA+2NK	83011136001			24,56



Açtırma ve Düşük Gerilim Bobinleri

	Model	Tanımı	Bağlantı Tipi	Sipariş Kodu	Besleme Gerilimi	Birlikte Kullanılacak Şalter Boyutu	Liste Fiyatı(\$)
	SHT24B	AÇTIRMA BOBİNİ (SHT)	Klemens Bloklu	83211187712	AC/DC24V	30AF~250AF	28,25
	SHT200B			83211187715	AC/DC200~250V		28,25
	SHT380B			83211187716	AC380~450V		28,25
	SHT24LWT			83211137001	AC24~48V	400AF~800AF	69,29
	SHT100LWT			83211137002	AC100~240V - DC100~220V		69,29
	SHT380LWT			83211137003	AC380~550V		69,29
	UVT24	DÜŞÜK GERİLİM BOBİNİ (UVT)	Klemens Bloklu	83211187011	AC/DC24V	30AF~250AF	51,39
	UVT200			83211187014	AC/DC200~220V		51,39
	UVT380			83211187015	AC380~440V	400AF~800AF	51,39
	UVTLWT200			83211137023	AC200~240V - DC200~220V		89,91
UVTLWT380	83211137024	AC380~440V	89,91				

Döner Kurma Kolları

	Model	Tipi	Birlikte Kullanılan Şalterler		Sipariş Kodu	Açıklama	Liste Fiyatı (\$)
			Şalter	Kaçak Akım Şalteri			
	DH100	Standart Tip	ABS30c/50c/60c	EBS30c/50c/60c	83111187002	DH100 Standart Tip Döner Kurma Kolu	46,29
	DH 125		ABS125c,ABH50c/125c,ABL125c	EBS125c,EBH50c/125c	83111187011	DH125 Standart Tip Döner Kurma Kolu	46,29
	DH 250		ABN/S/H/L250c	EBN/S/H250c	83111187021	DH250 Standart Tip Döner Kurma Kolu	46,29
	N-70		ABN/S/H/L400c	EBN/S/H/L400c	83111138101	N70 Standart Tip Döner Kurma Kolu	95,01
	N-80		ABN/S/L800c	EBN/S/L800c	83111138111	N80 Standart Tip Döner Kurma Kolu	95,01
	DHK100		Standart Kilitli Tip	ABS30c/50c/60c	EBS30c/50c/60c	83111187007	DHK100 Standart Kilitli Tip Döner Kurma Kolu
DHK 125	ABS125c,ABH50c/125c,ABL125c	EBS125c,EBH50c/125c		83111187017	DHK125 Standart Kilitli Tip Döner Kurma Kolu	64,25	
DHK 250	ABN/S/H/L250c	EBN/S/H250c		83111187027	DHK250 Standart Kilitli Tip Döner Kurma Kolu	64,25	
	EH100	Uzatmalı	ABS30c/50c/60c	EBS30c/50c/60c	83111187004	EH100 Standart Kilitli Tip Döner Kurma Kolu	69,29
	EH 125		ABS125c,ABH50c/125c,ABL125c	EBS125c,EBH50c/125c	83111187014	EH125 Uzatmalı Tip Döner Kurma Kolu	69,29
	EH 250		ABN/S/H/L250c	EBN/S/H250c	83111187024	EH250 Uzatmalı Tip Döner Kurma Kolu	69,29
	E-70U		ABN/S/H/L400c	EBN/S/H/L400c	55221138111	E-70U Uzatmalı Tip Döner Kurma Kolu	154,16
	E-80U		ABN/S/L800c	EBN/S/L800c	55221138112	E-80U Uzatmalı Tip Döner Kurma Kolu	177,21

Terminal Kapakları

	Model	Tip	Kutup	Sipariş Kodu	Birlikte Kullanılan Şalterler		Liste Fiyatı(\$)
					Şalter	Kaçak akım şalteri	
	TCS23	KISA TİP	3P	64621187215	ABS125c,ABH50c/125c, ABL125c	EBS125c, EBH50c/125c	4,79
	TCS24		4P	64621187216			6,25
	TCS33	KISA TİP	3P	64621187225	ABN/S/H/L250c	EBN/S/H250c	6,25
	TCS34		4P	64621187226			6,61
	TCL23	UZUN TİP	3P	64621187212	ABS125c,ABH50c/125c, ABL125c	EBS125c,EBH50c/125c	5,14
	TCL24		4P	64621187213			6,61
	TCL33	UZUN TİP	3P	64621187222	ABN/S/H/L250c	EBN/S/H250c	6,61
	TCL34		4P	64621187223			7,31

Susol Serisi Kompakt Şalterler

Trip Üniteleri (100AF - 800AF)

TE ve TD serisi ürünlerin açma üniteleri sabit,
TS serisi ürünlerin açma üniteleri değiştirilebilir tiptir.



Model

- TS: Seri
- 250: Maksimum akım
- S: Standart
- N: Normal
- H: Yüksek
- L: Arttırılmış

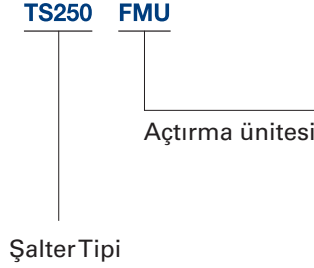

	160AF	250AF	630AF	800AF	1600AF
S	TE100S TE160S	-	-	-	-
N	TE100N TE160N TD100N TD160N	TS100N TS160N TS250N -	TS400N TS630N -	TS800N -	TS1000N TS1250N TS1600N -
H	TD100H TD160H -	TS100H TS160H TS250H	TS400H TS630H -	TS800H -	TS1000H TS1250H TS1600H
L	TD100L TD160L -	TS100L TS160L TS250L	TS400L TS630L -	TS800L -	TS1000L -

Akım Değerlerine Göre Şalter Dağılımları

Şalter Tipi	Nominal akım In[A]						
	Açırma ünitesi				Elektronik açırma ünitesi		DSU
	FTU	FMU	ATU	MTU	ETS	ETM	
TE100 TD100	16, 20, 25, 32, 40, 50, 63, 80, 100	16, 20, 25, 32, 40, 50, 63, 80, 100	-	-	-	-	-
TE160 TD160	100, 125, 160	100, 125, 160	-	-	-	-	160
TS100	40, 50, 63, 80, 100	40, 50, 63, 80, 100	-	1.6, 3.2, 6.3, 12, 20, 32, 50, 63, 100	40, 80	-	100
TS160	100, 125, 160	100, 125, 160	125, 160	32, 50, 63, 100, 160	40, 80, 160	-	160
TS250	125, 160, 200, 250	125, 160, 200, 250	125, 160, 200, 250	100, 160, 220	40, 80, 160, 250	-	250
TS400	300, 400	300, 400	300, 400	320	160, 250, 400	160, 250, 400	400
TS630	500, 630	500, 630	500, 630	500	160, 250, 400, 630	160, 250, 400, 630	630
TS800	700, 800	800	800	630	630, 800	630, 800	800

FTU Sabit termik, sabit manyetik

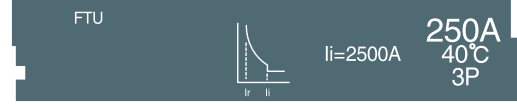

FMU Ayarlanabilir termik, sabit manyetik

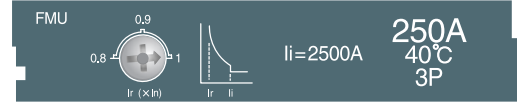

ATU Ayarlanabilir termik, ayarlanabilir manyetik

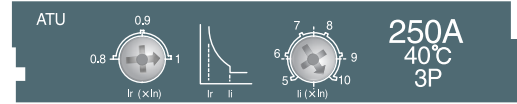

MTU Ayarlanabilir manyetik

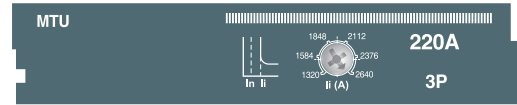

DSU Yük ayırıcı



ETS Standart tip elektronik (LSI)

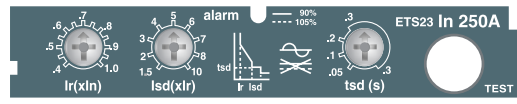

ETM Çok fonksiyonlu tip elektronik (LSIG)

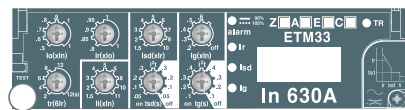

3 Kutuplu Ayarlanabilir Termik / Ayarlanabilir Manyetik Tip Kompakt Şalterler (ATU Açırma Ünitesi) (Ics=%100 Icu)

Model	Anma Akımı (A)	Termik Ayar akımı (A)	Manyetik Ayar akımı (A)	Kesme Kapasitesi Icu (kA)	Sipariş Kodu	Açıklama	Liste Fiyatı(\$)		
TS160	125A	100-125	Ayarlı (5-10)In	50kA	01050259	TS160N ATU160 125A 3P	308,92		
	160A	128-160			01050258	TS160N ATU160 160A 3P	308,92		
TS250	200A	160-200			01050229	TS250N ATU250 200A 3P	350,28		
	250A	200-250			01050230	TS250N ATU250 250A 3P	350,28		
TS400	300A	240-300			Ayarlı (5-10)In	65kA	01080025	TS400N ATU400 300A 3P	782,30
	400A	320-400					01080026	TS400N ATU400 400A 3P	782,30
TS630	500A	400-500	01080031	TS630N ATU630 500A 3P			1.021,63		
	630A	500-630	01080032	TS630N ATU630 630A 3P			1.021,63		
TS800	800A	640-800	01110013	TS800N ATU800 800A 3P			1.395,26		
TS160	125A	100-125	Ayarlı (5-10)In	85kA			01050257	TS160H ATU160 125A 3P	427,73
	160A	128-160			01050256	TS160H ATU160 160A 3P	427,73		
TS250	200A	160-200			01050231	TS250H ATU250 200A 3P	507,42		
	250A	200-250			01050232	TS250H ATU250 250A 3P	507,42		
TS400	300A	240-300			01080027	TS400H ATU400 300A 3P	882,34		
	400A	320-400			01080028	TS400H ATU400 400A 3P	882,34		
TS630	500A	400-500			01080033	TS630H ATU630 500A 3P	1.376,20		
	630A	500-630			01080034	TS630H ATU630 630A 3P	1.376,20		
TS800	800A	640-800			01110014	TS800H ATU800 800A 3P	1.538,02		

4 Kutuplu Ayarlanabilir Termik / Ayarlanabilir Manyetik Tip Kompakt Şalterler (ATU Açırma Ünitesi) (Ics=%100 Icu)

Model	Anma Akımı (A)	Termik Ayar akımı (A)	Manyetik Ayar akımı (A)	Kesme Kapasitesi Icu (kA)	Sipariş Kodu	Açıklama	Liste Fiyatı(\$)		
TS160	125A	100-125	Ayarlı (5-10)In	50kA	01060470	TS160N ATU160 125A 4P3D	399,60		
	160A	128-160			01060471	TS160N ATU160 160A 4P3D	399,60		
TS250	200A	160-200			01060457	TS250N ATU250 200A 4P3D	507,92		
	250A	200-250			01060458	TS250N ATU250 250A 4P3D	507,92		
TS400	400A	320-400			Ayarlı (5-10)In	65kA	01090050	TS400N ATU400 400A 4P3D	986,29
TS630	500A	400-500					01090055	TS630N ATU630 500A 4P3D	1.333,59
	630A	500-630	01090056	TS630N ATU630 630A 4P3D			1.333,59		
TS800	800A	640-800	01120025	TS800N ATU800 800A 4P3D			1.661,47		
TS160	125A	100-125	Ayarlı (5-10)In	85kA			01060472	TS160H ATU160 125A 4P3D	546,54
	160A	128-160					01060473	TS160H ATU160 160A 4P3D	546,54
TS250	200A	160-200			01060459	TS250H ATU250 200A 4P3D	615,39		
	250A	200-250			01060460	TS250H ATU250 250A 4P3D	615,39		
TS400	300A	240-300			01090051	TS400H ATU400 300A 4P3D	1.098,64		
	400A	320-400			01090052	TS400H ATU400 400A 4P3D	1.098,64		
TS630	500A	400-500			01090057	TS630H ATU630 500A 4P3D	1.517,80		
	630A	500-630			01090058	TS630H ATU630 630A 4P3D	1.517,80		
TS800	800A	640-800			01120026	TS800H ATU800 800A 4P3D	1.861,82		

4 Kutuplu Nötr Korunmalı Ayarlanabilir Termik / Ayarlanabilir Manyetik Tip Kompakt Şalterler (ATU Açırma Ünitesi) (Ics=%100 Icu)

Model	Anma Akımı (A)	Termik Ayar akımı (A)	Manyetik Ayar akımı (A)	Kesme Kapasitesi Icu (kA)	Sipariş Kodu	Açıklama	Liste Fiyatı(\$)
TS 250N	200A	160-200	Ayarlı (5-10)In	50kA	01060463	TS250N ATU 200 A 4L 4P4D	572,12
	250A	200-250			01060464	TS250N ATU 250 A 4L 4P4D	572,12
TS 400N	300A	240-300	Ayarlı (5-10)In	65kA	01090061	TS400N ATU 300 A 4L 4P4D	1.049,87
	400A	320-400			01090062	TS400N ATU 400 A 4L 4P4D	1.049,87
TS 630N	500A	400-500	Ayarlı (5-10)In	65kA	01090067	TS630N ATU 500 A 4L 4P4D	1.390,32
	630A	504-630			01090068	TS630N ATU 630 A 4L 4P4D	1.390,32
TS 800N	800A	640-800	Ayarlı (5-10)In	65kA	01120028	TS800N ATU 800 A 4L 4P4D	1.740,39
TS 250H	200A	160-200	Ayarlı (5-10)In	85kA	01060465	TS160H ATU 200 A 4L 4P4D	644,23
	250A	200-250			01060466	TS250H ATU 250 A 4L 4P4D	644,23
TS 400H	300A	240-300	Ayarlı (5-10)In	85kA	01090063	TS400H ATU 300 A 4L 4P4D	1.145,32
	400A	320-400			01090064	TS400H ATU 400 A 4L 4P4D	1.145,32
TS 630H	500A	400-500	Ayarlı (5-10)In	85kA	01090069	TS630H ATU 500 A 4L 4P4D	1.598,72
	630A	504-630			01090070	TS630H ATU 630 A 4L 4P4D	1.598,72
TS 800H	800A	640-800	Ayarlı (5-10)In	100kA	01120029	TS800H ATU 800 A 4L 4P4D	1.942,72

Susol Serisi Kompakt Tip Şalterler

3 Kutuplu Ayarlanabilir Termik / Sabit Manyetik Tip Kompakt Şalterler (FMU Açırma Ünitesi) (Ics=%100 Icu)

Model	Anma Akımı (A)	Termik Ayar akımı (A)	Manyetik Ayar akımı (A)	Kesme Kapasitesi Icu (kA)	Sipariş Kodu	Açıklama	Liste Fiyatı(\$)
TE100	16A	13-16	400	37kA	01610034	TE100S FMU 16A 3P	190,12
	20A	16-20			01610035	TE100S FMU 20A 3P	190,12
	25A	20-25			01610036	TE100S FMU 25A 3P	190,12
	32A	26-32			01610037	TE100S FMU 32A 3P	190,12
	40A	32-40	Sabit (10In)	37kA	01610038	TE100S FMU 40A 3P	190,12
	50A	40-50			01610039	TE100S FMU 50A 3P	190,12
	63A	50-63			01610040	TE100S FMU 63A 3P	190,12
	80A	64-80			01610041	TE100S FMU 80A 3P	190,12
	100A	80-100			01610042	TE100S FMU 100A 3P	190,12
	TE160	125A			100-125	01610043	TE160S FMU 125A 3P
160A		128-160	01610044	TE160S FMU 160A 3P	222,80		
TE100	16A	13-16	400	50kA	01610023	TE100N FMU 16A 3P	210,89
	20A	16-20			01610024	TE100N FMU 20A 3P	210,89
	25A	20-25			01610025	TE100N FMU 25A 3P	210,89
	32A	26-32			01610026	TE100N FMU 32A 3P	210,89
	40A	32-40	Sabit (10In)	50kA	01610027	TE100N FMU 40A 3P	210,89
	50A	40-50			01610028	TE100N FMU 50A 3P	210,89
	63A	50-63			01610029	TE100N FMU 63A 3P	210,89
	80A	64-80			01610030	TE100N FMU 80A 3P	210,89
	100A	80-100			01610031	TE100N FMU 100A 3P	210,89
	TE160	125A			100-125	Sabit (10In)	50kA
160A		128-160	01610033	TE160N FMU 160A 3P	249,52		
TS250	200A	160-200	Sabit (10In)	50kA	01050209	TS250N FMU 200A 3P	339,06
	250A	200-250			01050210	TS250N FMU 250A 3P	339,06
TS400	300A	240-300	Sabit (10In)	65kA	01080013	TS400N FMU 300A 3P	797,11
	400A	320-400			01080014	TS400N FMU 400A 3P	797,11
TS630	500A	400-500	Sabit (10In)	65kA	01080019	TS630N FMU 500A 3P	948,62
	630A	504-630			01080020	TS630N FMU 630A 3P	948,62
TS800	800A	640-800	Sabit (10In)	65kA	01110008	TS800N FMU 800A 3P	1.253,78
TS100	16A	13-16	Sabit (10In)	85kA	01020097	TD100H FMU 16A 3P	308,74
	20A	16-20			01020098	TD100H FMU 20A 3P	308,74
	25A	20-25			01020099	TD100H FMU 25A 3P	308,74
	32A	26-32			01020100	TD100H FMU 32A 3P	308,74
	40A	32-40			01020101	TD100H FMU 40A 3P	308,74
	50A	40-50			01020102	TD100H FMU 50A 3P	308,74
	63A	50-63			01020103	TD100H FMU 63A 3P	308,74
	80A	64-80			01020104	TD100H FMU 80A 3P	308,74
	100A	80-100			01020105	TD100H FMU 100A 3P	308,74
	TS160	125A			100-125	Sabit (10In)	85kA
160A		128-160	01020163	TD160H FMU 160A 3P	398,75		
TS250	200A	160-200	Sabit (10In)	85kA	01050218	TS250H FMU 200A 3P	485,80
	250A	200-250			01050219	TS250H FMU 250A 3P	485,80
TS400	300A	240-300	Sabit (10In)	85kA	01080015	TS400H FMU 300A 3P	843,52
	400A	320-400			01080016	TS400H FMU400 A 3P	843,52
TS630	500A	400-500	Sabit (10In)	85kA	01080021	TS630H FMU500 A 3P	1.296,72
	630A	504-630			01080022	TS630H FMU630 A 3P	1.296,72
TS800	800A	640-800	Sabit (10In)	100kA	01110010	TS800H FMU800 A 3P	1.389,34

4 Kutuplu Ayarlanabilir Termik / Sabit Manyetik Tip Kompakt Şalterler (FMU Açırma Ünitesi) (Ics=%100 Icu)

Model	Anma Akımı (A)	Termik Ayar akımı (A)	Manyetik Ayar akımı (A)	Kesme Kapasitesi Icu (kA)	Sipariş Kodu	Açıklama	Liste Fiyatı(\$)
TE100	16A	13-16	400	37kA	01620034	TE100S FMU 16A 4P	243,56
	20A	16-20			01620035	TE100S FMU 20A 4P	243,56
	25A	20-25			01620036	TE100S FMU 25A 4P	243,56
	32A	26-32			01620037	TE100S FMU 32A 4P	243,56
	40A	32-40	Sabit (10In)	37kA	01620038	TE100S FMU 40A 4P	243,56
	50A	40-50			01620039	TE100S FMU 50A 4P	243,56
	63A	50-63			01620040	TE100S FMU 63A 4P	243,56
	80A	64-80			01620041	TE100S FMU 80A 4P	243,56
	100A	80-100			01620042	TE100S FMU 100A 4P	243,56
TE160	125A	100-125	Sabit (10In)	50kA	01620043	TE160S FMU 125A 4P	291,13
	160A	128-160			01620044	TE160S FMU 160A 4P	291,13
TE100	16A	13-16	400	50kA	01620023	TE100N FMU 16A 4P	285,17
	20A	16-20			01620024	TE100N FMU 20A 4P	285,17
	25A	20-25			01620025	TE100N FMU 25A 4P	285,17
	32A	26-32			01620026	TE100N FMU 32A 4P	285,17
	40A	32-40	Sabit (10In)	50kA	01620027	TE100N FMU 40A 4P	285,17
	50A	40-50			01620028	TE100N FMU 50A 4P	285,17
	63A	50-63			01620029	TE100N FMU 63A 4P	285,17
	80A	64-80			01620030	TE100N FMU 80A 4P	285,17
	100A	80-100			01620031	TE100N FMU 100A 4P	285,17
	125A	100-125			Sabit (10In)	50kA	01620032
160A	128-160	01620033	TE160N FMU 160A 4P	314,87			
TS250	200A	160-200	Sabit (10In)	50kA	01060323	TS250N FMU 200A 4P	492,80
	250A	200-250			01060324	TS250N FMU 250A 4P	492,80
TS400	300A	240-300	Sabit (10In)	65kA	01090025	TS400N FMU 300A 4P	884,44
	400A	320-400			01090026	TS400N FMU 400A 4P	884,44
TS630	500A	400-500	Sabit (10In)	65kA	01090031	TS630N FMU 500A 4P	1.214,37
	630A	504-630			01090032	TS630N FMU 630A 4P	1.214,37
TS800	800A	640-800	Sabit (10In)	65kA	01120014	TS800N FMU 800A 4P	1.564,32
TD100	16A	13-16	Sabit (10In)	85kA	01030184	TD100H FMU 16A 4P	360,17
	20A	16-20			01030185	TD100H FMU 20A 4P	360,17
	25A	20-25			01030186	TD100H FMU 25A 4P	360,17
	32A	26-32			01030187	TD100H FMU 32A 4P	360,17
	40A	32-40			01030188	TD100H FMU 40A 4P	360,17
	50A	40-50			01030189	TD100H FMU 50A 4P	360,17
	63A	50-63			01030190	TD100H FMU 63A 4P	360,17
	80A	64-80			01030191	TD100H FMU 80A 4P	360,17
	100A	80-100			01030192	TD100H FMU 100A 4P	360,17
	125A	100-125			Sabit (10In)	85kA	01030249
160A	128-160	01030250	TD160H FMU 160A 4P	512,04			
TS250	200A	160-200	Sabit (10In)	85kA	01060332	TS250H FMU 200A 4P	593,15
	250A	200-250			01060333	TS250H FMU 250A 4P	593,15
TS400	300A	240-300	Sabit (10In)	85kA	01090027	TS400H FMU 300A 4P	1.035,48
	400A	320-400			01090028	TS400H FMU400 A 4P	1.035,48
TS630	500A	400-500	Sabit (10In)	85kA	01090033	TS630H FMU500 A 4P	1.457,27
	630A	504-630			01090034	TS630H FMU630 A 4P	1.457,27
TS800	800A	640-800	Sabit (10In)	100kA	01120016	TS800H FMU800 A 4P	1.811,31

Susol Serisi Kompakt Tip Şalterler

3 Kutuplu Sabit Termik / Ayarlanabilir Manyetik Tip Kompakt Şalterler (MTU Açırma Ünitesi) (Ics=%100 Icu) (Motor Koruma Şalteri)

Model	Anma Akımı (A)	Termik Ayar akımı (A)	Manyetik Ayar akımı (A)	Kesme Kapasitesi Icu (kA)	Sipariş Kodu	Açıklama	Liste Fiyatı(\$)
TS100N	1,6A	-	(6-12) In	50kA	01050314	TS100N MTU 1.6A 3P	254,60
	3,2A	-			01050313	TS100N MTU 3.2A 3P	254,60
	6,3A	-			01050312	TS100N MTU 6.3A 3P	254,60
	12A	-		01050311	TS100N MTU 12A 3P	254,60	
	20A	-		01050310	TS100N MTU 20A 3P	227,33	
	32A	-		01050309	TS100N MTU 32A 3P	227,33	
	50A	-		01050308	TS100N MTU 50 A 3P	227,33	
	63A	-		01050307	TS100N MTU 63 A 3P	227,33	
	100A	-		01050235	TS100N MTU 100 A 3P	227,33	
TS160N	160A	-	65kA	01050241	TS160N MTU 160 A 3P	252,65	
TS250N	220A	-		01050250	TS 250N MTU 220 A 3P	349,32	
TS400N	320A	-	65kA	01080037	TS 400N MTU 320 A 3P	650,68	
TS630N	500A	-		01080040	TS 630N MTU 500 A 3P	822,95	
TS 800N	630A	-	65kA	01110016	TS 800N MTU 630 A 3P	1.056,63	

2/3/4 Kutuplu Kompakt Tip Yük Ayırıcılar (DSU Açırma Ünitesi)

Model	Anma Akımı (A)	Termik Ayar akımı (A)	Manyetik Ayar akımı (A)	Kesme Kapasitesi Icu (kA)	Sipariş Kodu	Açıklama	Liste Fiyatı(\$)
TS100NA	100A	-	-	-	01010182	TD100NA DSU 100A 2P	264,10
	100A	-	-	-	01020182	TD100NA DSU 100A 3P	264,10
	100A	-	-	-	01030362	TD100NA DSU 100A 4P L	337,47
TS160NA	160A	-	-	-	01010181	TD160NA DSU 160A 2P	227,03
	160A	-	-	-	01020181	TD160NA DSU 160A 3P	252,50
	160A	-	-	-	01030361	TD160NA DSU 160A 4P L	324,11
TS200NA	200A	-	-	-	01040527	TS250NA DSU 200A 2P	329,86
	200A	-	-	-	01051194	TS250NA DSU 200A 3P	358,80
	200A	-	-	-	01061849	TS250NA DSU 200A 4P L	472,02
TS250NA	250A	-	-	-	01040235	TS250NA DSU 250A 2P	296,62
	250A	-	-	-	01050253	TS250NA DSU 250A 3P	325,27
	250A	-	-	-	01060469	TS250NA DSU 250A 4P L	428,24
TS400NA	400A	-	-	-	01070037	TS400NA DSU 400A 2P	701,46
	400A	-	-	-	01080043	TS400NA DSU 400A 3P	701,76
	400A	-	-	-	01090073	TS400NA DSU 400A 4P L	896,22
TS630NA	630A	-	-	-	01070038	TS630NA DSU 630A 2P	645,69
	630A	-	-	-	01080044	TS630NA DSU 630A 3P	755,63
	630A	-	-	-	01090074	TS630NA DSU 630A 4P L	877,72
TS800NA	800A	-	-	-	01100016	TS800NA DSU 800A 2P	1.206,50
	800A	-	-	-	01110019	TS800NA DSU 800A 3P	1.007,46
	800A	-	-	-	01120031	TS800NA DSU 800A 4P L	1.395,00
TS1000NA	1000A	-	-	-	01710257	TS1000NA 1000A 3P	1.844,57
	1000A	-	-	-	01750513	TS1000NA 1000A 4P L	2.359,04
TS1250NA	1250A	-	-	-	01720129	TS1250NA 1250A 3P	2.013,81
	1250A	-	-	-	01760257	TS1250NA 1250A 4P L	2.621,61
TS1600NA	1600A	-	-	-	01730129	TS1600NA 1600A 3P	2.393,69
	1600A	-	-	-	01770257	TS1600NA 1600A 4P L	3.212,42

ETS

ETS23 In 250A

1 Anma Akımı Ayarı (Ir)

2 Kısa Süreli Gecikme Ayarı (Isd)

3 Gecikme Ayarı (tsd)

4 Alarm LED
90% Ir : ON
105% > Ir : ON - OFF

5 Test Konnektörü

ETM

ETM33 In 630A

1 Anma Akımı Ayarı (Ir)

2 Uzun Süreli Gecikme Ayarı (tr)

3 Kısa Süreli Gecikme Ayarı (Isd)

4 Gecikme Ayarı (tsd)

5 Ani Akım Ayarı (Ir)

6 Toprak Hatası Ayarı (Irg)

7 Toprak Hatası Gecikme Ayarı (tg)

8 Gösterge LED'leri

9 Trip Kabul Butonu

10 LCD Gösterge (Akım)

11 Yardımcı Besleme

12 Test Konnektörü

13 Alarm LED

3 Kutuplu Standart Elektronik Açtırma Üniteli Kompakt Tip Şalterler (ETS Açtırma Üniteli) (Ics=%100 Icu)

Model	Anma Akımı (A)	Termik Ayar akımı (A)	Manyetik Ayar akımı (A)	Zaman Gecikme Ayarı (ms)	Kesme Kapasitesi Icu (kA)	Sipariş Kodu	Açıklama	Liste Fiyatı(\$)	
TS 100	40A	32-40	Ayarlı (1.5-10) In	Ayarlı (0.05-3)	50kA	01050260	TS100N ETS23 40 A 3P	399,05	
	80A	63-80				01050263	TS100N ETS23 80 A 3P	399,05	
	100A	80-100				01050769	TS100N ETS23 100 A 3P	399,05	
TS 160	160A	128-160				01050272	TS250N ETS23 160 A 3P	372,52	
	TS 250	250A				200-250	01050284	TS250N ETS23 250 A 3P	455,37
		TS 400				400A	320-400	01080051	TS400N ETS33 400 A 3P
TS 630	630A				500-630	01080063	TS630N ETS33 630 A 3P	1.295,21	
	TS 800	800A			640-800	01110023	TS800N ETS43 800 A 3P	1.477,36	

4 Kutuplu Standart Elektronik Açtırma Üniteli Kompakt Tip Şalterler (ETS Açtırma Üniteli) (Ics=%100 Icu)

Model	Anma Akımı (A)	Termik Ayar akımı (A)	Manyetik Ayar akımı (A)	Zaman Gecikme Ayarı (ms)	Kesme Kapasitesi Icu (kA)	Sipariş Kodu	Açıklama	Liste Fiyatı(\$)	
TS 100	40A	32-40	Ayarlı (1.5-10) In	Ayarlı (0.05-3)	50kA	01061020	TS100N ETS23 40 A 4P	411,95	
	80A	63-80				01061026	TS100N ETS23 80 A 4P	411,95	
	100A	80-100				01061653	TS100N ETS23 100 A 4P	411,95	
TS 160	160A	128-160				01061044	TS250N ETS23 160 A 4P	422,19	
	TS 250	250A				200-250	01061068	TS250N ETS23 250 A 4P	688,90
		TS 400				400A	320-400	01090317	TS400N ETS33 400 A 4P
TS 630	630A				500-630	01090341	TS630N ETS33 630 A 4P	1.538,02	
	TS 800	800A			640-800	01120117	TS800N ETS43 800 A 4P	1.780,94	

3 Kutuplu Çok Fonksiyonlu Elektronik Açtırma Üniteli Kompakt Tip Şalterler (ETM Açtırma Üniteli) (Ics=%100 Icu)

Model	Anma Akımı (A)	Termik Ayar akımı (A)	Manyetik Ayar akımı (A)	Zaman Gecikme Ayarı (ms)	Kesme Kapasitesi Icu (kA)	Sipariş Kodu	Açıklama	Liste Fiyatı(\$)
TS 400	160A	128-160	Ayarlı (1.5-10) In	Ayarlı (50-300)	65A	01080066	TS400N ETM33 160A 3P	1.229,63
	250A	200-250				01080069	TS400N ETM33 250A 3P	1.229,63
	400A	320-400				01080072	TS400N ETM33 400A 3P	1.229,63
TS 630	630A	504-630				01080084	TS630N ETM33 630A 3P	1.659,21
	TS 800	800A				640-800	01110029	TS800N ETM43 800A 3P

4 Kutuplu Çok Fonksiyonlu Elektronik Açtırma Üniteli Kompakt Tip Şalterler (ETM Açtırma Üniteli) (Ics=%100 Icu)

Model	Anma Akımı (A)	Termik Ayar akımı (A)	Manyetik Ayar akımı (A)	Zaman Gecikme Ayarı (ms)	Kesme Kapasitesi Icu (kA)	Sipariş Kodu	Açıklama	Liste Fiyatı(\$)
TS 400	160A	128-160	Ayarlı (1.5-10) In	Ayarlı (50-300)	65A	01090347	TS400N ETM33 160A 4P L	1.357,27
	250A	200-250				01090353	TS400N ETM33 250A 4P L	1.357,27
	400A	320-400				01090359	TS400N ETM33 400A 4P L	1.357,27
TS 630	630A	504-630				01090383	TS630N ETM33 630A 4P L	1.831,16
	TS 800	800A				640-800	01120129	TS800N ETM43 800A 4P L

ETM Tip Açtırma Üniteleri İçin Opsiyonlar

Opsiyon	Şalter Tipi	Referans
A	TS 400 □ ETM	A: Ampermetre
E	TS 630 □ ETM	E: Toprak Kaçak Koruma
Z	TS 800 □ ETM	Z: Selektif Koruma Modülü
A+E	TS 400 □ ETM	C: Haberleşme
A+C	TS 630 □ ETM	
Z+A	TS 800 □ ETM	
A+E+C	TS 400 □ ETM	A: Ammeter
Z+A+E	TS 630 □ ETM	E: Earth Fault Protection
Z+A+C	TS 800 □ ETM	Z: Zone Selective Interlocking
Z+A+E+C	TS 400 □ ETM	C: Communication
	TS 630 □ ETM	
	TS 800 □ ETM	

* Örnek/ "TS630H ETM33 630A 3P"ye "Ampermetre & Toprak Arıza Koruma" fonksiyonu eklenmesi halinde

• Ürün adı "TS630H ETM33 630A 3P AE" olur. (Sipariş vermeden önce mutlaka kontrol ediniz)

• Ürün Fiyatı "TS630H ETM33 630A 3P temel fiyat + opsiyon fiyatıdır"

• Ürünlerin fiyat bilgisi için yetkili satış kanallarımız ile temasa geçebilirsiniz.

Susol Serisi Kompakt Tip Şalterler

Ürün Ailesi Genel Görünümü (1000AF/1600AF)



Model		
Amper		
Kutup		
Anma Akımı,(A)	In	-5~40°C 50°C 65°C
Anma Yalıtım Gerilimi,(V)	Ui	
Anma Darbe Dayanma Gerilimi,(kV)	Uimp	
Anma Çalışma Gerilimi,(V)	Ue	AC50/60Hz DC
Anma Maksimum Kısa Devre Kesme Kapasitesi		
IEC60947-2	Anma Maksimum	220/240V
AC50/60Hz	Kısa Devre Kesme	380/415V
(sym)	Kapasitesi (kA) (Icu)	440/460V
		480/500V
		660/690V
	DC	250V 2P
		500V 2P
		750V 3P
Anma İşletme Kısa Devre Kesme Kapasitesi, Ics (%Icu) (kA)		
	Belirtilen Kısa Süreli Dayanma Akımı (kA) (Icw) AC50/60Hz	1s 3s
İlk Anlık Koruma	kA peak	
İzolasyon		
Kullanım Kategorisi		
	Mekaniksel Ömür	
	Elektriksel Ömür	440V In/2 In 690V In/2 In
Kirlilik Derecesi		
Boyutlar (mm)	3-kutup	
(W×H×D)	4-kutup	
Ağırlık (kg)	3-kutup 4-kutup	

TS1000			TS1250		TS1600	
TS1000			TS1250		TS1600	
1000			1250		1600	
3, 4			3, 4		3, 4	
800, 1000			1250		1600	
800, 1000			1250		1560	
800, 1000			1240		1420	
1000			1000		1000	
8			8		8	
690			690		690	
-			-		-	
N	H	L	N	H	N	H
55	75	200	55	75	55	75
50	70	150	50	70	50	70
50	65	130	50	65	50	65
40	50	100	40	50	40	50
35	45	-	35	45	35	45
-	-	-	-	-	-	-
-	-	-	-	-	-	-
-	-	-	-	-	-	-
100%	75%	100%	100%	75%	100%	75%
25		12	25		25	
-		-	-		-	
50		30	50		50	
○			○		○	
B		A	B		B	
10000		4000	10000		10000	
6000		4000	5000		5000	
5000		3000	4000		2000	
4000		3000	3000		2000	
2000		2000	2000		1000	
3			3		3	
			210×327×152.5			
			280×327×152.5			
			13			
			16.8			

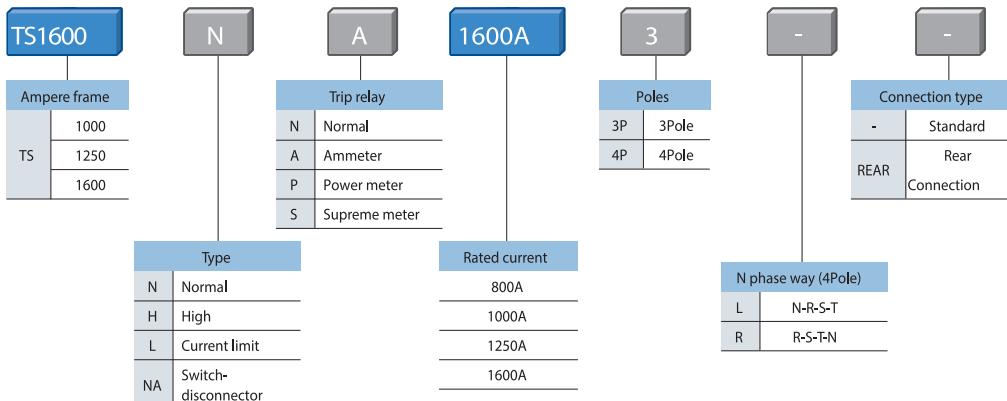

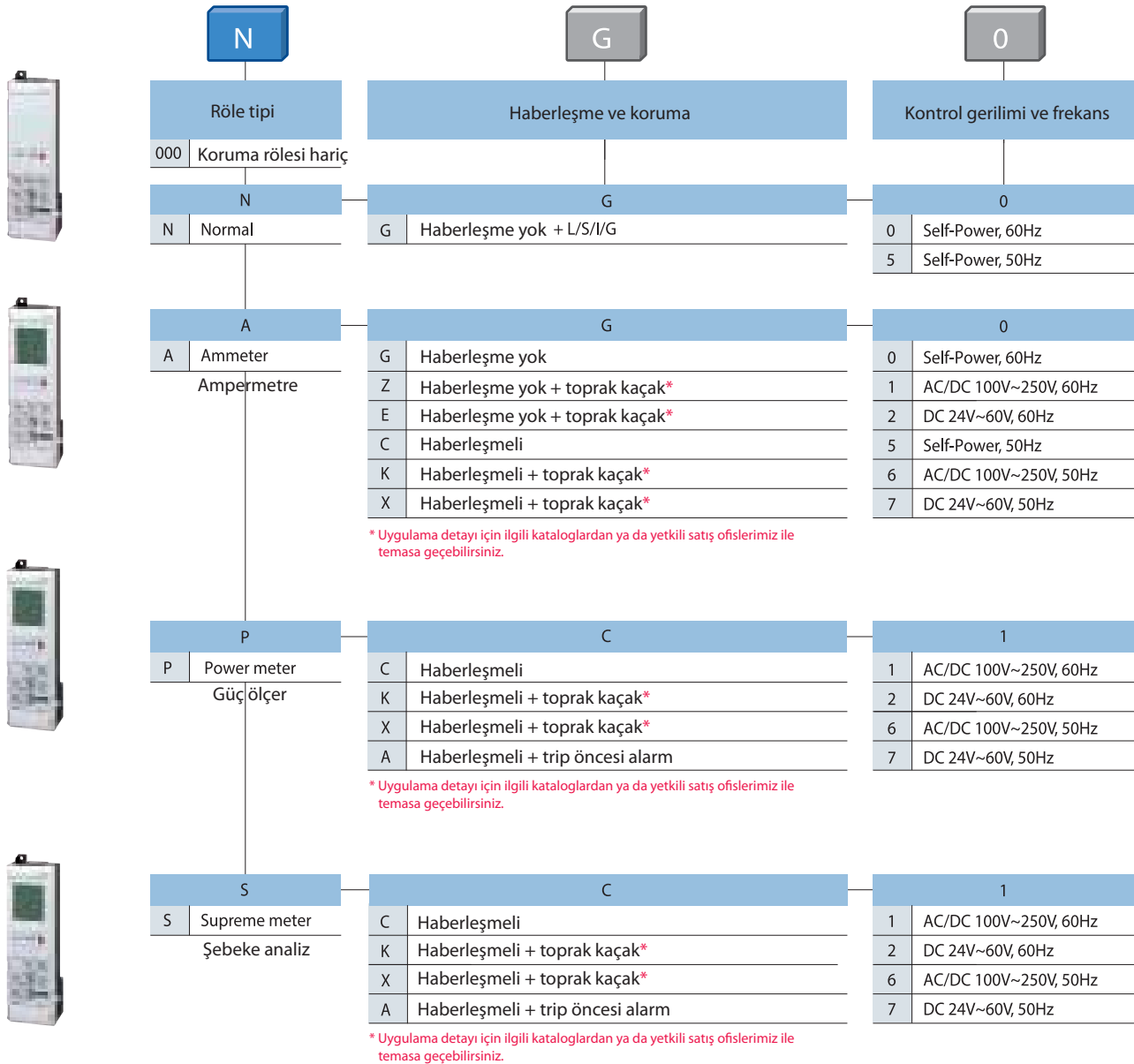

3/4 Kutuplu Kompakt Tip Şalterler (NGO Tip Açırma Ünitesi, 1000AF/1600AF)*

Model	Anma Akımı (A)	Termik Ayar Akımı (A)	Kesme Kapasitesi Icu (kA)	Kutup Sayısı	Sipariş Kodu	Açıklama	Liste Fiyatı(\$)
TS1000N	800A	400-800A	50	3P	01710001	TS1000N NGO 800A 3P	2.362,67
TS1000N	1000A	500-1000A			01710065	TS1000N NGO 1000A 3P	2.368,54
TS1250N	1250A	625-1250A			01720001	TS1250N NGO 1250A 3P	2.715,43
TS1600N	1600A	800-1600A			01730001	TS1600N NGO 1600A 3P	3.744,33
TS1000H	800A	400-800A	70	3P	01710129	TS1000H NGO 800A 3P	2.551,52
TS1000H	1000A	500-1000A			01710193	TS1000H NGO 1000A 3P	2.488,45
TS1250H	1250A	625-1250A			01720065	TS1250H NGO 1250A 3P	2.872,31
TS1600H	1600A	800-1600A			01730065	TS1600H NGO 1600A 3P	3.957,89
TS1000N	800A	400-800A	50	4P	01750001	TS1000N NGO 800A 4P L	3.334,92
TS1000N	1000A	500-1000A			01750065	TS1000N NGO 1000A 4P L	3.343,31
TS1250N	1250A	625-1250A			01760001	TS1250N NGO 1250A 4P L	3.692,78
TS1600N	1600A	800-1600A			01770001	TS1600N NGO 1600A 4P L	5.065,86
TS1000H	800A	400-800A	70	4P	01750129	TS1000H NGO 800A 4P L	3.435,03
TS1000H	1000A	500-1000A			01750193	TS1000H NGO 1000A 4P L	3.860,16
TS1250H	1250A	625-1250A			01760065	TS1250H NGO 1250A 4P L	4.229,78
TS1600H	1600A	800-1600A			01770065	TS1600H NGO 1600A 4P L	5.778,79

* Fiyat listesindeki ürünler NGO açırma ünitesi olup, farklı tip ürünlerimiz için yetkili satış kanallarımız ile temasa geçebilirsiniz.

Susol Serisi Kompakt Tip Şalterler

Yardımcı Donanımlar

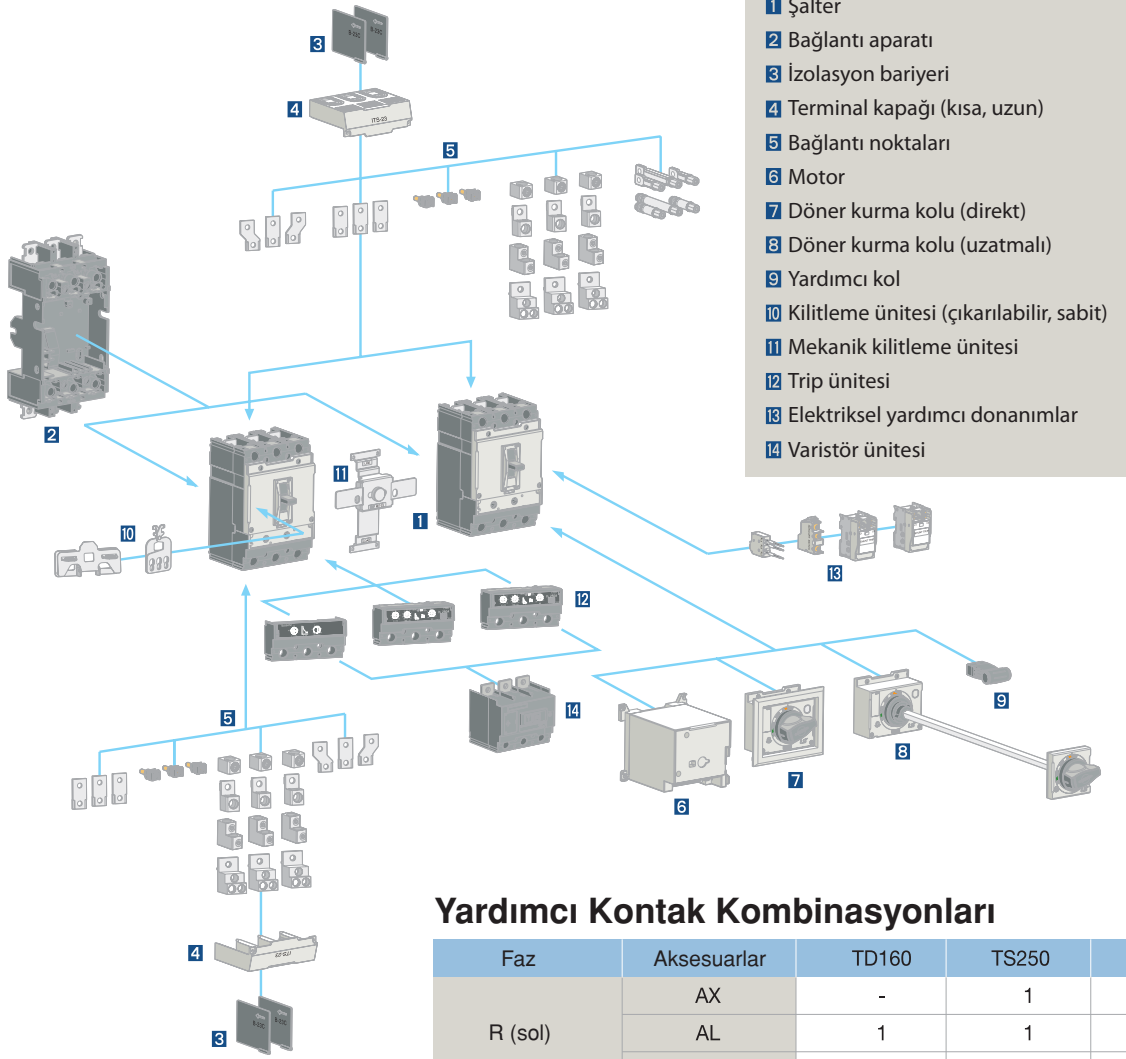

- 1 Şalter
- 2 Bağlantı aparatı
- 3 İzolasyon bariyeri
- 4 Terminal kapağı (kısa, uzun)
- 5 Bağlantı noktaları
- 6 Motor
- 7 Döner kurma kolu (direkt)
- 8 Döner kurma kolu (uzatmalı)
- 9 Yardımcı kol
- 10 Kilitleme ünitesi (çıkarılabilir, sabit)
- 11 Mekanik kilitleme ünitesi
- 12 Trip ünitesi
- 13 Elektriksel yardımcı donanımlar
- 14 Varistör ünitesi

Yardımcı Kontakt Kombinasyonları

Faz	Aksesuarlar	TD160	TS250	TS630	TS800
R (sol)	AX	-	1	3	3
	AL	1	1	-	-
	SHT or UVT	1	1	1	1
T (sağ)	AX	2	1	-	-
	AL	-	-	1	2
	FAL	-	1	1	1

Not: TS sadece MCCB'lerin elektronik tip trip ünitelerinde kullanılır.

Mekanik Kilitler (Changeover için)

	Model	Tip	3/4 Kutup	Sipariş Kodu	Açıklama	Liste Fiyatı(\$)	
	MIT13E	MEKANİK KİLİT	3-kutup	56121175801	MIT13E	TD100/TD160 İÇİN	81,75
	MIT14E		4-kutup	56121175802	MIT14E		81,75
	MIT13		3-kutup	56121171811	MIT13		160,01
	MIT14		4-kutup	56121171812	MIT14	TS100/160/250 İÇİN	160,01
	MIT23		3-kutup	56121172811	MIT23		171,92
	MIT24		4-kutup	56121172812	MIT24	171,92	
	MIT33		3-kutup	56121173813	MIT33	TS400/630 İÇİN	204,49
	MIT34		4-kutup	56121173814	MIT34		204,49
	MIT43		3-kutup	56121174813	MIT43	TS800 İÇİN	225,32
	MIT44		4-kutup	56121174814	MIT44		225,32
	MIT53		3-kutup	56121176801	MIT53	TS1600 İÇİN	234,18

Manuel Kilitleme Üniteleri

	Model	Fonksiyon	Beraber kullanılan şalterler	Sipariş Kodu	Açıklama	Liste Fiyatı(\$)	
	PHL1	Sabit Tip	ON yada OFF Pozisyonunda	TD160	56771171802	LOCK ASS'Y,PHL1,TD160	44,06
	PHL2			TS250	56771172802	LOCK ASS'Y,PHL2,TS250	44,06
	PHL3			TS630	56771173802	LOCK ASS'Y,PHL3,TS630	55,09
	PHL4			TS800	56771174802	LOCK ASS'Y,PHL4,TS800	65,10
	PL1	Çıkarılabilir Tip	OFF Pozisyonunda	TD160	56771171801	LOCK ASS'Y,PL1,TD160	54,80
	PL2			TS250	56771172801	LOCK ASS'Y,PL2,TS250	57,17
	PL3			TS630	56771173801	LOCK ASS'Y,PL3,TS630	48,43
	PL4			TS800	56771174801	LOCK ASS'Y,PL4,TS800	55,38

Yardımcı Donanımlar

Motor Mekanizmaları

Model	Kontrol Gerilimi	Kullanılacak Şalter Tipleri	Sipariş Kodu	Açıklama	Liste Fiyatı(\$)
MOP-M1	DC24V	TD100,TD160	83471171901	MOTOR MEKANİZMASI,MOP1,DC24V	414,87
	AC100~240V		83471171902	MOTOR MEKANİZMASI,MOP1,AC100~240V/DC100~220V	414,87
MOP-M2	DC24V	TS100, TS160, TS250	83471172901	MOTOR MEKANİZMASI,MOP2,DC24V	577,96
	AC110V/ DC110V		83471172902	MOTOR OPERATOR,MOP2,AC110V/DC110V	577,96
	AC230V/ DC220V		83471172903	MOTOR MEKANİZMASI,MOP2,AC230V/DC220V	577,96
MOP-M3	DC24V	TS400, TS630	83471173901	MOTOR MEKANİZMASI,MOP3,DC24V	785,42
	AC110V/ DC110V		83471173902	MOTOR OPERATOR,MOP3,AC110V/DC110V	785,42
	AC230V/ DC220V		83471173903	MOTOR MEKANİZMASI,MOP3,AC230V/DC220V	785,42
MOP-M4	DC24V	TS800	83471174901	MOTOR MEKANİZMASI,MOP4,DC24V	933,63
	AC110V/ DC110V		83471174902	MOTOR OPERATOR,MOP4,AC110V/DC110V	933,63
	AC230V/ DC220V		83471174903	MOTOR MEKANİZMASI,MOP4,AC230V/DC220V	933,63
MOP-M7	DC24V	TE100,TE160	83471175901	MOTOR MEKANİZMASI,MOP-M7,DC24V,	359,61
	AC230V/ DC220V		83471175903	MOTOR MEKANİZMASI,MOP-M7,AC230V/DC220V	359,61

TE100-160 Serisi İçin Yardımcı Donanımlar

Model	Tanımı	Bağlantı Tipi	Sipariş Kodu	Açıklama	Liste Fiyatı(\$)
AX	Yardımcı Kontakt	Kablo Bağlantılı	83011175701	A,AX,R,W,TE160	34,73
			83011175704	A,AX,T,W,TE160	34,73
AL	Alarm Kontak	Kablo Bağlantılı	83011175702	A,AL,R,W,TE160	34,73
			83011175705	A,AL,T,W,TE160	34,73
AX+AL	Kombine Kontakt	Kablo Bağlantılı	83011175703	A,AX/AL,R,W,TE160	63,49
			83011175706	A,AX/AL,T,W,TE160	63,49
SHT	Açtırma Bobini	Klemens Bloku	83211175732	T,SHT,T,AC/DC24V,TE160	56,48
			83211175736	T,SHT,T,AC/DC200~250V,TE160	56,48
			83211175737	T,SHT,T,AC 380~450V,TE160	56,48
UVT	Düşük Gerilim Bobini	Klemens Bloku	83211175751	T,UVT,T,AC/DC24V,TE160	115,18
			83211175754	T,UVT,T,AC/DC200~220V,TE160	115,18
			83211175755	T,UVT,T,AC380~440V,TE160	115,18

TD100-TS1600 Serisi İçin Yardımcı Donanımlar

Model	Tanımı	Sipariş Kodu	Açıklama	Liste Fiyatı(\$)
AX	YARDIMCI KONTAK	83011171701	A,AX,TD100-TS800 İÇİN	34,74
AX	YARDIMCI KONTAK	83011171704	A,AX,LWT,TD100-TS800	38,13
AL	ALARM KONTAĞI	83011171702	A,AL,TD100-TS800 İÇİN	34,74
FAL	HATA KONTAĞI	83011171703	A,FAL,TD100-TS800 İÇİN	69,40
AX1	YARDIMCI KONTAK	83011176201	A,AX,TS1600 İÇİN	38,13
AL1	ALARM KONTAĞI	83011176203	A,AL,TS1600 İÇİN	38,13
FAL1	HATA KONTAĞI	83011176251	A,FAL,TS1600 İÇİN	80,08
SHT24S	Açtırma Bobini	83211171732	T,SHT,AC/DC24V,TD100-TS800 İÇİN	65,26
SHT220S		83211171735	T,SHT,AC220~240VDC250V,TD100-TS800 İÇİN	65,26
SHT380S		83211171736	T,SHT,AC/DC380~500V,TD100-TS800 İÇİN	65,26
SHT24S1		83211176221	T,SHT,DC24~30V,TS1600 İÇİN	121,49
SHT201S		83211176224	T,SHT,AC/DC200~250V,TS1600 İÇİN	121,49
SHT381S		83211176225	T,SHT,AC380~480V,TS1600 İÇİN	121,49
UVT24S	Düşük Gerilim Bobini	83211171751	T,UVT,AC/DC24V,TD100-TS800 İÇİN	115,18
UVT220S		83211171754	T,UVT,AC220~240V/DC250V,TD100-TS800 İÇİN	115,18
UVT380S		83211171755	T,UVT,AC380~440V,TD100-TS800 İÇİN	115,18
UVT24S1		83211176241	T,UVT,DC24~30V,TS1600 İÇİN	154,16
UVT201S		83211176244	T,UVT,AC200~250V,TS1600 İÇİN	154,16
UVT381S		83211176245	T,UVT,AC380~480V,TS1600 İÇİN	154,16

Susol Serisi Kompakt Tip Şalterler

Yardımcı Donanımlar

TS Serisi Kaçak Akım Algılama Modülleri

Model	Birlikte Kullanılacak Şalter Tipleri	Sipariş Kodu	Açıklama	Liste Fiyatı (\$)
RTU23	TS100/160	83481172601	RCD,RTU23,AC220/460V,TS100/160	429,81
		83481172602	RCD,RTU23,AC460/690V,TS100/160	429,82
	TS250	83481172603	RCD,RTU23,AC220/460V,TS250	429,81
		83481172604	RCD,RTU23,AC460/690V,TS250	429,82
RTU33	TS400	83481173601	RCD,RTU33,AC220/460V,TS400	607,56
		83481173602	RCD,RTU33,AC460/690V,TS400	607,57
	TS630	83481173603	RCD,RTU33,AC220/460V,TS630	607,56
		83481173604	RCD,RTU33,AC460/690V,TS630	607,57
RTU43	TS800	83481174601	RCD,RTU43,AC220/460V,TS800	814,94
		83481174602	RCD,RTU43,AC460/690V,TS800	814,94

		RTU23	RTU24	RTU33	RTU34	RTU43
Kutup sayısı		3*	4	3*	4	3*
Birlikte kullanılacak şalter	TS100	■	■			
	TS160	■	■			
	TS250	■	■			
	TS400			■	■	
	TS630			■	■	
	TS800					■
Koruma karakteristikleri						
Hassasiyet	$I_{\Delta n}$ (A)	(ayarlanabilir) 0.03-0.3-1-3-10				
Zaman gecikmesi **	Kasıtlı zaman gecikmesi (ms)	(ayarlanabilir) 0-60-150-300-600				
	Max. breaking time (ms)	(ayarlanabilir) 40-150-300-600-990				
Çalışma gerilimi	AC 50/60 Hz	220-460V / 460-690V				

2) RTU can not be applied to MCCB (Electronic trip unit) + D/E-Handle

- Not 1) RTU, 63A veya daha düşük MTU tipi MCCB'ye uygulanamaz.
 2) MCCB (Elektronik açma ünitesi) + D/E-Tutamak'a RTU uygulanamaz.
 3) RTU24, RTU34: Yalnızca N-R-S-T tipi MCCB kombinasyonu mümkündür.
 4) RTU24 sadece Temmuz 18'den sonra üretilen termik-manyetik ünite ve Mart'tan sonra üretilen elektronik ünite ile birleştirilebilir. 2019.
 5) RTU34, sadece Eylül ayından sonra üretilen termik-manyetik ünite ve elektronik ünite ile kombine edilebilir. 2019.
 * 3P modülleri 2P devre kesicilerde de kullanılabilir.
 ** Hassasiyet 30mA olarak ayarlanırsa zaman gecikmesi ayarı sıfıra düşürülür.

Trip zaman gecikme ayarı
0-60-150-300-600ms

Hassasiyet ayarı $I_{\Delta n}$
0.03-0.3-1-3-10A



Çekmece (Plug-in) Ünitesi

Model	Birlikte Kullanılacak Şalter Tipleri	Kutup Sayısı	Sipariş Kodu	Açıklama	Liste Fiyatı (\$)
PB 12	TD100,160	2P	83171171001	PLUG-IN,PB12,TD100,TD160	155,54
PB 13		3P	83171171002	PLUG-IN,PB13,TD100,TD160	223,47
PB 12 D2		2P	83171171003	PLUG-IN,PB12D2,TD100,TD160	310,81
PB 13 D2		3P	83171171004	PLUG-IN,PB13D2,TD100,TD160	446,97
PB 22	TS100,160,250	2P	83171172001	PLUG-IN,PB22,TS100,TS160,TS250	202,95
PB 23		3P	83171172002	PLUG-IN,PB23,TS100,TS160,TS250	278,89
PB 32	TS400,630	2P	83171173001	PLUG-IN,PB32,TS400,TS630	341,66
PB 33		3P	83171173002	PLUG-IN,PB33,TS400,TS630	503,46
PB 42	TS800	2P	83171174001	PLUG-IN,PB42,TS800	937,56
PB 43		3P	83171174002	PLUG-IN,PB43,TS800	1.284,31

Çekmece (Plug-in) Ünitesi Konnektör Kiti

Model	Birlikte Kullanılacak Şalter Tipleri	Sipariş Kodu	Açıklama	Liste Fiyatı (\$)
Hareketli Parça	TD160	83261171806	SPARE PART ASS'Y,BASE CONNECTOR,TD160	11,03
	TS250	83261172804	SPARE PART ASS'Y,BASE CONNECTOR,TS250	11,37
	TS630	83261173806	SPARE PART ASS'Y,BASE CONNECTOR,TS630	11,75
	TS800	83261174806	SPARE PART ASS'Y,BASE CONNECTOR,TS800	12,10
Sabit Parça	TD160~TS800	83261171807	SPARE PART ASS'Y,CONNECTOR KIT,TD160	55,09

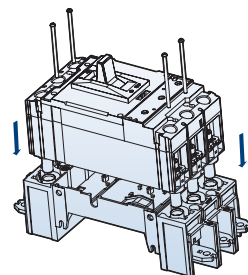

Plug In Ünitesi

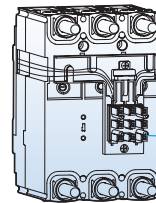

Sabit Parça

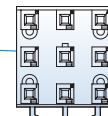

Hareketli Parça

Yardımcı Donanımlar

Kurma Kolları

	Model	Tanımı	Sipariş Kodu	Açıklama	Liste Fiyatı (\$)
	DH1E	Standart	83111175801	KURMA KOLU,DH1-E,TE160 İÇİN	36,87
	DH1		83111171801	KURMA KOLU,DH1-S,TD160 İÇİN	60,97
	DH2		83111172801	KURMA KOLU,DH2-S,TS250 İÇİN	60,97
	DH3		83111173801	KURMA KOLU,DH3-S,TS630 İÇİN	118,62
	DH4		83111174801	KURMA KOLU,DH4-S,TS800 İÇİN	165,95
	DH5		83111176281	KURMA KOLU,DH5-S,TS1600 İÇİN	503,83
	EH1E	Uzatmalı	83111175804	KURMA KOLU,EH1-E,TE160 İÇİN	90,67
	EH1		83111171806	KURMA KOLU,EH1-S,TD160 İÇİN	103,73
	EH2		83111172806	KURMA KOLU,EH2-S,TS250 İÇİN	103,73
	EH3		83111173806	KURMA KOLU,EH3-S,TS630 İÇİN	180,84
	EH4		83111174806	KURMA KOLU,EH4-S,TS800 İÇİN	198,64
	EH5		83111176294	KURMA KOLU,EH5-S,TS1600 İÇİN	563,09
	DHK1	STANDART - KİLİTLİ TİP	83111171811	KURMA KOLU,DHK1-S,TD160 İÇİN	126,13
	DHK2		83111172811	KURMA KOLU,DHK2-S,TS250 İÇİN	126,13
	DHK3		83111173811	KURMA KOLU,DHK3-S,TS630 İÇİN	182,45
	DHK4		83111174811	KURMA KOLU,DHK4-S,TS800 İÇİN	209,18
	DHK5		83111176287	KURMA KOLU,DHK5-S,TS1600 İÇİN	651,99

Terminal Kapakları

	Model	Tip	3/4 Kutup	Sipariş Kodu	Açıklama	Liste Fiyatı (\$)	
	ITS13E	KISA TİP	3-Kutup	64621175301	TERMINAL KAPAĞI	ITS13E,TE160 İÇİN	6,75
	ITS14E		4-Kutup	64621175303		ITS14E,TE160 İÇİN	7,61
	ITS13L	UZUN TİP	3-Kutup	64621175305		ITS13E,TE160 İÇİN	8,69
	ITS14L		4-Kutup	64621175306		ITS14E,TE160 İÇİN	8,69
	ITS13	KISA TİP	3-Kutup	64621171011		ITS13,TD160 İÇİN	10,59
	ITS14		4-Kutup	64621171012		ITS14,TD160 İÇİN	11,45
	ITL13	UZUN TİP	3-Kutup	64621171013		ITL13,TD160 İÇİN	13,11
	ITL14		4-Kutup	64621171014		ITL14,TD160 İÇİN	15,23
	ITS23	KISA TİP	3-Kutup	64621172011		ITS23,TS250 İÇİN	11,45
	ITS24		4-Kutup	64621172015		ITS24,TS250 İÇİN	11,85
	ITL23	UZUN TİP	3-Kutup	64621172016		ITL23,TS250 İÇİN	22,90
	ITL24		4-Kutup	64621172017		ITL24,TS250 İÇİN	29,19
	ITS33	KISA TİP	3-Kutup	64621173011		ITS33,TS630 İÇİN	18,21
	ITS34		4-Kutup	64621173012		ITS34,TS630 İÇİN	22,44
	ITL33	UZUN TİP	3-Kutup	64621173013		ITL33,TS630 İÇİN	44,48
	ITL34		4-Kutup	64621173014		ITL34,TS630 İÇİN	47,50
	ITS43	KISA TİP	3-Kutup	64621174011		ITS43,TS800 İÇİN	29,19
	ITS44		4-Kutup	64621174012		ITS44,TS800 İÇİN	34,24
	ITL43	UZUN TİP	3-Kutup	64621174013		ITL43,TS800 İÇİN	81,75
	ITL44		4-Kutup	64621174014		ITL44,TS800 İÇİN	99,44

İzolasyon Bariyerleri

	Model	Beraber kullanılan şalterler	Sipariş Kodu	Açıklama	Liste Fiyatı (\$)
	B-23C	TD160,TS160	83261171081	B-23C İzolasyon bariyeri	349,46
	B-33C	TS400,TS630	83261173081	B-33C İzolasyon bariyeri	484,37
	B-43C	TS800	83261174081	B-43C İzolasyon bariyeri	461,30

Metasol Eksiksiz ve Kompakt Ürün Ailesi

Metasol Açık tip şalter ürün ailesi 6300 A kadar 4 farklı şasi boyutunda eksiksiz seçenekler sunar. Tasarım ve montaj aşamasında optimize çözümler sunmanız için geliştirilmiştir.

630 ~ 1600 AF (AN)
630 ~ 2000 AF (AS)

2000 ~ 4000 AF (AS)

4000 ~



(65kA)

(70kA)

70kA

85kA

AN-06~16D

06	630AF
08	800AF
10	1000AF
13	1250AF
16	1600AF

Icu=Ics=65kA/500Vac
W=334(3p), 419(4p)mm

AS-06~20D

06	630AF
08	800AF
10	1000AF
13	1250AF
16	1600AF
20	2000AF

Icu=Ics=70kA/500Vac
W=334(3p), 419(4p)mm

AS-20~40E

20	2000AF
25	2500AF
32	3200AF
40	4000AF

Icu=Ics=85kA/500Vac
W=412(3p), 527(4p)mm



5000 AF (AS)

4000 ~ 6300 AF (AS)



D=375mm

W = 629mm

W = 785mm

...100kA120kA

AS-50F

40	4000AF
50	5000AF

Icu=Ics=100kA/500Vac
W=629(3p), 799(4p)mm

AS-40~63G

40	4000AF
50	5000AF
63	6300AF

Icu=Ics=120kA/500Vac
W=785(3p), 1015(4p)mm

- Standart L, S, I, G koruma
- 4 farklı şasi boyutu
2000/4000/5000/6300 AF
- 4 farklı açtırma rölesi tipi
N/A/P/S
- N fazı akım taşıma kapasitesi: %100

Sipariş Kodu Oluşturma

AS		10		D		3		10		J							
Tip		Şasi boyutu		Faz sırası		Kutup sayısı		Anma akımı		Bağlantı tipi							
Şalter		06	630AF	D	630~2000AF 3P/4P Standard RST(N)	3	3P(D)	00	Koruma rölesi hariç	Çekmeceli tip							
AN		08	800AF			4	4P(D, W)	02	200A	J	Manuel bağlantı						
AS		10	1000AF			W	630~2000AF 4P Ters (N)RST	3	3P(E)	04	400A	A	Otomatik bağlantı				
		13	1250AF							4	4P(E, X)	06	630A	Sabit tip			
		16	1600AF									10	1000A	H	Yatay		
		20	2000AF	13	1250A							V	Dikey				
		25	2500AF	16	1600A							M	Yatay / Dikey				
		32	3200AF	20	2000A	N	Dikey / Yatay										
		40	4000AF	E	2000~4000AF 3P/4P Standard RST(N)	3	3P(F)	20	2000A	P	Önden						
		40	4000AF					X	2000~4000AF 4P Ters (N)RST	4	4P(F, Y)	02	200A				
		50	5000AF									F	4000/5000AF 3P/4P Standard RST(N)	04	400A		
		50	5000AF											Y	4000/5000AF 4P Ters (N)RST	06	630A
		63	6300AF													G	4000/5000/6300AF 3P/4P Standard RST(N)
		63	6300AF	Z	4000/5000/6300AF 4P Ters (N)RST	10	1000A										
						AS	40	4000A	13	1250A							
									AS	50	5000A	16	1600A				
												AS	63	6300A	20		
															AS	50	5000A
				AS	63												
						AS	63	6300A									
									AS	63	6300A						
												AS	63	6300A			

Çekmece Ünitesi

AL		N16D		3		J		H		E		N	
Çekmece ünitesi		Şasi boyutu		Kutup sayısı		Bağlantı tipi		Montaj		Güvenlik bariyeri		Ark kapağı	
	N06-16D	AN-06-16D	3	3P	A	Otomatik	H	Yatay tip	E	Güvenlik bariyersiz	N	Ark kapaksız	
	S06-16D	AS-06-16D	4	4P	J	Manuel	V	Dikey tip	F	Güvenlik bariyerli	S	Ark kapaklı	
	S20D	AS-20D					M	Yatay / Dikey					
	S20-25E	AS-20-25E					N	Dikey / Yatay					
	S32E	AS-32E					P	Önden					
	S40E	AS-40E											
	S40-50F	AS-40-50F											
	S40-50G	AS-40-50G											
	S63G	AS-63G											

M1
Motor kontrol gerilimi

MA	Motor hariç
M1	AC/DC 100V~130V
M2	AC/DC 200V~250V
M3	DC 125V
M4	DC 24V~30V
M5	DC 48V~60V
M6	AC 380V~415V
M7	AC 440V~480V
M8	AC 48V

D1
Açtırma bobini kontrol gerilimi

D0	Bobin hariç
D1	AC/DC 100V~130V
D2	AC/DC 200V~250V
D3	DC 125V
D4	DC 24V~30V
D5	DC 48V~60V
D6	AC 380V~480V
D7	AC 48V

AX
NGO
Açtırma rölesi

Sayfa: 54

U1
AL
Kapama bobini kontrol gerilimi

D0	Bobin hariç
D1	AC/DC 100V~130V
D2	AC/DC 200V~250V
D3	DC 125V
D4	DC 24V~30V
D5	DC 48V~60V
D6	AC 380V~480V
D7	AC 48V

Yardımcı kontak tipi

AX	Standard OFF-Charge 3a3b
AC	Standard ON-Charge 3a3b
BX	Standard OFF-Charge 5a5b
BC	Standard ON-Charge 5a5b
HX	High capacity OFF-Charge 5a5b
HC	High capacity ON-Charge 5a5b
CC	Standard ON-Charge 6a6b
JC	High capacity ON-Charge 6a6b
GX	High capacity OFF-Charge 3a3b
GC	High capacity ON-Charge 3a3b
TX	TCS OFF-Charge 4a4b
TC	TCS ON-Charge 5a5b

Düşük gerilim bobini kontrol gerilimi

U0	Bobin hariç
U1	AC/DC 100V~130V
U2	AC/DC 200V~250V
U3	DC 125V
U4	DC 24V~30V
U5	DC 48V~60V
U6	AC 380V~480V
U7	AC 48V

Opsiyon	Açıklama	Opsiyon	Açıklama	
AL	AL1+MRB	B2	B2	
A1	AL1+MRB+RES (AC110~130V)	M	MI	
A2	AL1+AL2+MRB	D	DI	
A3	AL1+MRB+RES (DC110~125V)		Door Interlock	
A4	AL1+MRB+RES (AC200~250V)	MOC	Mechanism operated cell switch	
A5	AL1+MRB+Auto reset	K	K1	
A6	AL1+AL2+MRB+Auto reset	K2	K2	
A7	AL1+MRB+RES (DC110~125V)+Auto reset	K3	K3	
A8	AL1+MRB+RES (AC200~250V)+Auto reset	K4	K4	
A9	AL1+MRB+RES (AC110~130V)+Auto reset	R	RCS	
Y2	AL1+AL2+MRB (2b contact)	T	TM	
Y6	AL1+AL2+MRB+Auto reset (2b contact)	H1 H2 H3 H4 H5 H6 H7	AC/DC 100~130V	
Z2	AL1+AL2+MRB (1a1b contact)		AC/DC 200~250V	
Z6	AL1+AL2+MRB+Auto reset (1a1b contact)		DC 125V	
C	C Counter		H4	DC 24~30V
S	CS2 Charge switch communication		H5	DC 48~60V
B	B On/Off Button lock		H6	AC 380~480V
B1	B1 On/Off Button lock		H7	AC 48V
(-V)	Without VDM module (External type VDM is required to order)			

Koruma Röleleri

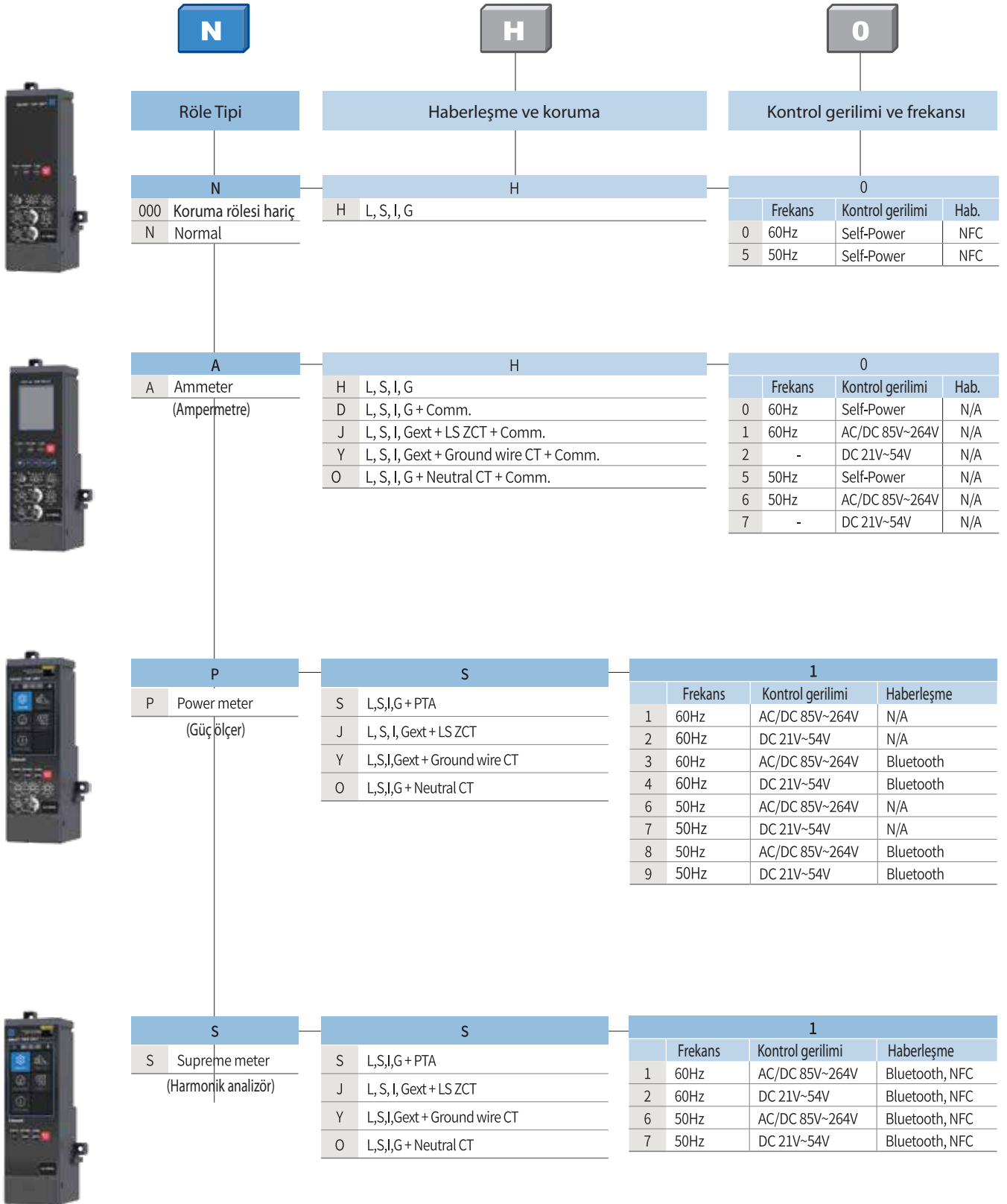

Arttırılmış Kullanıcı Konforu

- P ve S tipi koruma rölelerinde renkli grafik ekran aracılığı ile daha konforlu gözlem ve ayar imkanı.

3.5" dokunmatik renkli grafik ekran



IoT fonksiyonu standart

- BLE ve NFC ile şalter verilerinin akıllı cihazlardan (Cep telefonu, internet erişimi olan bilgisayar vb.) kolayca ulaşılabilme yeteneği.



Bara bağlantı çeşitleri

Standart bağlantı



Yatay Tip (H)



Dikey Tip (V)



Önden (P)

Karışık bağlantı



Yatay / Dikey



Dikey / Yatay



Yatay / Önden



Dikey / Önden



Önden / Yatay



Önden / Dikey

Standart Ürün Konfigürasyonu

MA	Motor Mekanizması	YOK
D0	Kapama Bobini	YOK
D0	Açtırma Bobini	YOK
FX	Kontak Sayısı	4NO4NK
NG5	Açtırma Ünitesi	NG5
U0	Düşük Gerilim Bobini	YOK
AL	Aksesuar	YOK

IEC60947-2 AC 415V/380V/220V İcs=%100 İcu LSIG Korumalı

Farklı tip konfigürasyon talepleriniz için yetkili satış kanallarımızdan bilgi alabilirsiniz.

Örnek Donatılı Ürün Konfigürasyonu

M2	Motor Mekanizması	AC/DC 200-250V
D2	Kapama Bobini	AC/DC 200-250V
D2	Açtırma Bobini	AC/DC 200-250V
AX	Kontak Sayısı	3NO3NK
NG5	Açtırma Ünitesi	NG5
U2	Düşük Gerilim Bobini	AC/DC 200-250V
AL	Aksesuar	YOK

Donatılı ürünler fabrikadan montajlı halde gelmekte olup, sipariş aşamasında belirtilmelidir.

3 Kutuplu Sabit Tip

Model	Anma Akımı (A)	Termik Ayar Sahası (A)	Kesme Kapasitesi	Sipariş Kodu Eski	Sipariş Kodu	Açıklama	Liste Fiyatı (\$)
AN-06D3-06H	630	200-630	65 kA	28951118	28951302	AN-06D3-06H MAD0D0AX NH5U0AL	4.098,78
AN-08D3-08H	800	320-800	65 kA	28960842	28961046	AN-08D3-08H MAD0D0AX NH5U0AL	4.098,78
AN-10D3-10H	1000	400-1000	65 kA	28971147	28971436	AN-10D3-10H MAD0D0AX NH5U0AL	4.057,84
AN-13D3-13H	1250	500-1250	65 kA	28981123	28981460	AN-13D3-13H MAD0D0AX NH5U0AL	4.057,84
AN-16D3-16H	1600	640-1600	65 kA	28991406	28991859	AN-16D3-16H MAD0D0AX NH5U0AL	4.057,84
AS-20D3-20V	2000	800-2000	70 kA	29080720	29080720.N	AS-20D3-20V MAD0D0AX NH5U0AL	4.609,58
AS-25E3-25H	2500	1000-2500	85 kA	29091217	29091645	AS-25E3-25H MAD0D0AX NH5U0AL	6.157,17
AS-32E3-32H	3200	1250-3200	85 kA	29101090	29101396	AS-32E3-32H MAD0D0AX NH5U0AL	6.716,04
AS-40E3-40V	4000	1600-4000	85 kA	29111404	29111762	AS-40E3-40V MAD0D0AX NH5U0AL	12.105,48
AS-50F3-50H	5000	2000-5000	100kA	29120869	29121154	AS-50F3-50H MAD0D0AX NH5U0AL	13.333,17
AS-63G3-63H	6300	2500-6300	120kA	29130334	29130462	AS-63G3-63H MAD0D0AX NH5U0AL	21.126,59

4 Kutuplu Sabit Tip

Model	Anma Akımı (A)	Termik Ayar Sahası (A)	Kesme Kapasitesi	Sipariş Kodu Eski	Sipariş Kodu	Açıklama	Liste Fiyatı (\$)
AN-06D4-06H	630	200-630	65 kA	28951117	28951305	AN-06D4-06H MAD0D0AX NH5U0AL	4.646,84
AN-08D4-08H	800	320-800	65 kA	28960843	28961048	AN-08D4-08H MAD0D0AX NH5U0AL	4.646,84
AN-10D4-10H	1000	400-1000	65 kA	28971144	28971438	AN-10D4-10H MAD0D0AX NH5U0AL	4.688,79
AN-13D4-13H	1250	500-1250	65 kA	28981122	28981456	AN-13D4-13H MAD0D0AX NH5U0AL	4.688,79
AN-16D4-16H	1600	640-1600	65 kA	28991405	28991856	AN-16D4-16H MAD0D0AX NH5U0AL	4.688,79
AS-20D4-20V	2000	800-2000	70 kA	29081293	29081293.N	AS-20D4-20V MAD0D0AX NH5U0AL	5.403,52
AS-25E4-25H	2500	1000-2500	85 kA	29091216	29091644	AS-25E4-25H MAD0D0AX NH5U0AL	6.437,64
AS-32E4-32H	3200	1250-3200	85 kA	29101089	29101395	AS-32E4-32H MAD0D0AX NH5U0AL	7.831,98
AS-40E4-40V	4000	1600-4000	85 kA	29111405	29111771	AS-40E4-40V MAD0D0AX NH5U0AL	14.621,46
AS-50F4-50H	5000	2000-5000	100kA	29120871	29120871.N	AS-50F4-50H MAD0D0AX NH5U0AL	15.374,30
AS-63G4-63H	6300	2500-6300	120kA	29130335	29130456	AS-63G4-63H MAD0D0AX NH5U0AL	23.461,68

3 Kutuplu Çekmeceli Tip

Model	Anma Akımı (A)	Termik Ayar Sahası (A)	Kesme Kapasitesi	Sipariş Kodu Eski	Sipariş Kodu	Açıklama	Liste Fiyatı (\$)
AN-06D3-06A	630	200-630	65 kA	28450677	28450677.N	AN-06D3-06A MADODOAX NH5U0AL	3.889,71
AN-08D3-08A	800	320-800	65 kA	28450678	28450678.N	AN-08D3-08A MADODOAX NH5U0AL	3.889,71
AN-10D3-10A	1000	400-1000	65 kA	28450679	28450679.N	AN-10D3-10A MADODOAX NH5U0AL	4.057,84
AN-13D3-13A	1250	500-1250	65 kA	28450680	28450680.N	AN-13D3-13A MADODOAX NH5U0AL	4.057,84
AN-16D3-16A	1600	640-1600	65 kA	28991506	28991506.N	AN-16D3-16A MADODOAX NH5U0AL	4.057,84
AS-20D3-20A	2000	800-2000	70 kA	28660141	28660141.N	AS-20E3-20A MADODOAX NH5U0AL	4.289,98
AS-25E3-25A	2500	1000-2500	85 kA	29091287	29091287.N	AS-25E3-25A MADODOAX NH5U0AL	4.922,79
AS-32E3-32A	3200	1250-3200	85 kA	29101108	29101108.N	AS-32E3-32A MADODOAX NH5U0AL	5.567,44
AS-40E3-40A	4000	1600-4000	85 kA	28890215	28890215.N	AS-40E3-40A MADODOAX NH5U0AL	6.620,25
AS-50F3-50A	5000	2000-5000	100kA	29120872	29120872.N	AS-50F3-50A MADODOAX NH5U0AL	8.841,01
AS-63G3-63A	6300	2500-6300	120kA	29240088	29240088.N	AS-63G3-63A MADODOAX NH5U0AL	17.809,06

4 Kutuplu Çekmeceli Tip

Model	Anma Akımı (A)	Termik Ayar Sahası (A)	Kesme Kapasitesi	Sipariş Kodu Eski	Sipariş Kodu	Açıklama	Liste Fiyatı (\$)
AN-06D4-06A	630	200-630	65 kA	28450682	28450682.N	AN-06D4-06A MADODOAX NH5U0AL	4.368,68
AN-08D4-08A	800	320-800	65 kA	28450683	28450683.N	AN-08D4-08A MADODOAX NH5U0AL	4.368,68
AN-10D4-10A	1000	400-1000	65 kA	28450684	28450684.N	AN-10D4-10A MADODOAX NH5U0AL	4.688,79
AN-13D4-13A	1250	500-1250	65 kA	28450685	28450685.N	AN-13D4-13A MADODOAX NH5U0AL	4.688,79
AN-16D4-16A	1600	640-1600	65 kA	28991080	28991080.N	AN-16D4-16A MADODOAX NH5U0AL	4.688,79
AS-20D4-20A	2000	800-2000	70 kA	29080865	29080865.N	AS-20E4-20A MADODOAX NH5U0AL	5.932,61
AS-25E4-25A	2500	1000-2500	85 kA	29210547	29210547.N	AS-25E4-25A MADODOAX NH5U0AL	6.036,28
AS-32E4-32A	3200	1250-3200	85 kA	29210548	29210548.N	AS-32E4-32A MADODOAX NH5U0AL	6.505,12
AS-40E4-40A	4000	1600-4000	85 kA	28890216	28890216.N	AS-40E4-40A MADODOAX NH5U0AL	7.712,25
AS-50F4-50A	5000	2000-5000	100kA	28899999	28899999.N	AS-50F4-50A MADODOAX NH5U0AL	10.149,11
AS-63G4-63A	6300	2500-6300	120kA	29240094	29240094.N	AS-63G4-63A MADODOAX NH5U0AL	20.161,84

Çekmece Ünitesi

Model	Beraber Kullanılan Kasalar	Kutup	Sipariş Kodu	Açıklama	Liste Fiyatı (\$)
Metasol	AN-06D3 ≈ AN-16D3	3	72313461441	AL-N16D3-AHES	1.888,24
Metasol	AS-20D3	3	72313461499	AL-S20D3-AVES	2.359,77
Metasol	AS-20E3 ≈ AH-25E3	3	72313463442	AL-S25E3-AHES	2.776,20
Metasol	AS-32E3	3	72313463823	AL-S32E3-AHES	3.060,71
Metasol	AS-40E3	3	72313463473	AL-S40E3-AVES	5.592,22
Metasol	AS-40F3 ≈ AS50F3	3	72313465481	AL-S50F3-AHES	6.710,66
Metasol	AS-63G3	3	72313465649	AL-S63G3-AHES	9.102,72
Metasol	AN-06D4 ≈ AN-16D4	4	72313462441	AL-N16D4-AHES	2.224,86
Metasol	AS-20D4	4	72313462499	AL-S20D4-AVES	2.925,31
Metasol	AS-20E4 ≈ AH-25E4	4	72313464442	AL-S25E4-AHES	3.441,54
Metasol	AS-32E4	4	72313464539	AL-S32E4-AHES	3.788,29
Metasol	AS-40E4	4	72313464473	AL-S40E4-AVES	7.238,81
Metasol	AS-40F4 ≈ AS50F4	4	72313465482	AL-S50F4-AHES	8.686,57
Metasol	AS-63G4	4	72313465650	AL-S63G4-AHES	11.700,39

Açık Tip Şalterler

Susol Compact Icu=50 & 60 kA, In=800-1600A,

Açık Tip Şalter Seçeneklerinizi Gözden Geçirin

High Performance
Ics=100%*Icu

Açık Tip Şalter ihtiyaçlarınızı için Boyut ve Maliyet Açısından Yeni Bir Evrim

Compact Size
55%↓

Performance UP
Size DOWN

Susol Super Solution Compact ACB 1600A

- Cat.A 150kA/415V
- Cat.B 50kA/690V, Icw = 50kA/1sec (30kA/3sec)

Fonksiyon Gereksimlerine bağlı olarak farklı koruma rölesi seçenekleri



N Tip (Normal)

Termik Koruma
L/S/I/G Termik
Enerji Beslemesi Gerektirmez
Dahili RTC
Hata Göstergesi (LED)

N
type

P Tip (Güç Ölçer)

A Tipinde yer alan tüm özelliklere ek olarak
Güç Ölçümü / Gerilim / Akım
Dengesiz Yük Koruma
L/S/I/G
Termik
UV / OV / OF / UF / rP / Vun / Iun
V/A/Wh/F/PF
ZSI(Alan Seçicili Kilitleme)
Uzaktan Reset
Modbus/RS-485
Profibus DP
AC/DC 100-250V
DC 24-60V
Dahili RTC
Olay ve Hata Kaydı (256+256)

P
type

A Tip (Akım Ölçer)

Akım Ölçer + Akım Koruma
+ DO koruma + Haberleşme
L/S/I/G
Termik
ZSI(Alan Seçici Kilitleme)
Uzaktan Reset
Modbus/RS-485
Profibus DP
Enerji Beslemesi Gerektirmez
AC/DC 100-250V
DC 24-60V
Dahili RTC
Kayıt Alma Yeteneği

A
type

S Tip (Harmonik Analiz)

P Tipinde yer alan tüm özelliklere ek olarak
Harmonik Analiz (63)
Dalga Yapısı Hata Kayıt

S
type

Susol Compact Icu=50 & 60 kA, In=800-1600A,

Standart Ürün Konfigürasyonu

MA	Motor Mekanizması	YOK
D0	Kapama Bobini	YOK
D0	Açtırma Bobini	YOK
FX	Kontak Sayısı	4N04NK
NG5	Açtırma Ünitesi	NG5
U0	Düşük Gerilim Bobini	YOK
AL	Aksesuar	YOK

IEC60947-2
AC 415V/380V/220V
Ics=%100 Icu
LSIG Korumalı

Farklı tip konfigürasyon talepleriniz için yetkili satış kanallarımızdan bilgi alabilirsiniz.

Örnek Donatılı Ürün Konfigürasyonu

M2	Motor Mekanizması	AC/DC 200-250V
D2	Kapama Bobini	AC/DC 200-250V
D2	Açtırma Bobini	AC/DC 200-250V
FX	Kontak Sayısı	4N04NK
NG5	Açtırma Ünitesi	NG5
U2	Düşük Gerilim Bobini	AC/DC 200-250V
AL	Aksesuar	YOK

Donatılı ürünler fabrikadan montajlı halde gelmekte olup, sipariş aşamasında belirtilmelidir.

3 Kutuplu Sabit Tip

Model	Anma Akımı (A)	Termik Ayar Sahası (A)	Kesme Kapasitesi	Sipariş Kodu	Açıklama	Liste Fiyatı (\$)
AN-08C3-06P	630	250-630	50 kA	Sorunuz!	AN-08C3-06P MADOD0FX NG5U0	2.934,70
AN-08C3-08P	800	320-800	50 kA	29400245	AN-08C3-08P MADOD0FX NG5U0	2.934,70
AN-16C3-10P	1000	400-1000	50 kA	Sorunuz!	AN-16C3-10P MADOD0FX NG5U0	3.205,41
AN-16C3-13P	1250	500-1250	50 kA	Sorunuz!	AN-16C3-13P MADOD0FX NG5U0	3.205,41
AN-16C3-16P	1600	640-1600	50 kA	29400244	AN-16C3-16P MADOD0FX NG5U0	3.205,41
AH-08C3-06H	630	250-630	60 kA	Sorunuz!	AH-08C3-06H MADOD0FX NG5U0	3.485,27
AH-08C3-08H	800	320-800	60 kA	29410133	AH-08C3-08H MADOD0FX NG5U0	3.485,27
AH-16C3-10H	1000	400-1000	60 kA	Sorunuz!	AH-16C3-10H MADOD0FX NG5U0	4.127,47
AH-16C3-13H	1250	500-1250	60 kA	Sorunuz!	AH-16C3-13H MADOD0FX NG5U0	4.127,47
AH-16C3-16H	1600	640-1600	60 kA	29410134	AH-16C3-16H MADOD0FX NG5U0	4.127,47

4 Kutuplu Sabit Tip

Model	Anma Akımı (A)	Termik Ayar Sahası (A)	Kesme Kapasitesi	Sipariş Kodu	Açıklama	Liste Fiyatı (\$)
AN-08C4-06P	630	250-630	50 kA	Sorunuz!	AN-08C4-06P MADOD0FX NG5U0	3.309,85
AN-08C4-08P	800	320-800	50 kA	29400242	AN-08C4-08P MADOD0FX NG5U0	3.309,85
AN-16C4-10P	1000	400-1000	50 kA	Sorunuz!	AN-16C4-10P MADOD0FX NG5U0	3.396,41
AN-16C4-13P	1250	500-1250	50 kA	Sorunuz!	AN-16C4-13P MADOD0FX NG5U0	3.396,41
AN-16C4-16P	1600	640-1600	50 kA	29400243	AN-16C4-16P MADOD0FX NG5U0	3.396,41
AH-08C4-06H	630	250-630	60 kA	Sorunuz!	AH-08C4-06H MADOD0FX NG5U0	3.777,20
AH-08C4-08H	800	320-800	60 kA	29410135	AH-08C4-08H MADOD0FX NG5U0	3.777,20
AH-16C4-10H	1000	400-1000	60 kA	Sorunuz!	AH-08C4-10H MADOD0FX NG5U0	4.886,33
AH-16C4-13H	1250	500-1250	60 kA	Sorunuz!	AH-08C4-13H MADOD0FX NG5U0	4.886,33
AH-16C4-16H	1600	640-1600	60 kA	29410136	AH-16C4-16H MADOD0FX NG5U0	4.886,33

3 Kutuplu Çekmeceli Tip

Model	Anma Akımı (A)	Termik Ayar Sahası (A)	Kesme Kapasitesi	Sipariş Kodu	Açıklama	Liste Fiyatı (\$)
AN-08C3-06A	630	250-630	50 kA	Sorunuz!	AN-08C3-06A MADOD0FX NG5U0	3.024,01
AN-08C3-08A	800	320-800	50 kA	29400234	AN-08C3-08A MADOD0FX NG5U0	3.024,01
AN-16C3-10A	1000	400-1000	50 kA	Sorunuz!	AN-16C3-10A MADOD0FX NG5U0	3.140,74
AN-16C3-13A	1250	500-1250	50 kA	Sorunuz!	AN-16C3-13A MADOD0FX NG5U0	3.140,74
AN-16C3-16A	1600	640-1600	50 kA	29400093	AN-16C3-16A MADOD0FX NG5U0	3.140,74
AH-08C3-06A	630	250-630	60 kA	Sorunuz!	AH-08C3-06A MADOD0FX NG5U0	3.240,14
AH-08C3-08A	800	320-800	60 kA	29410139	AH-08C3-08A MADOD0FX NG5U0	3.240,14
AH-16C3-10A	1000	400-1000	60 kA	Sorunuz!	AH-16C3-10A MADOD0FX NG5U0	3.882,24
AH-16C3-13A	1250	500-1250	60 kA	Sorunuz!	AH-16C3-13A MADOD0FX NG5U0	3.882,24
AH-16C3-16A	1600	640-1600	60 kA	29410140	AH-16C3-16A MADOD0FX NG5U0	3.882,24

4 Kutuplu Çekmeceli Tip

Model	Anma Akımı (A)	Termik Ayar Sahası (A)	Kesme Kapasitesi	Sipariş Kodu	Açıklama	Liste Fiyatı (\$)
AN-08C4-06A	630	250-630	50 kA	Sorunuz!	AN-08C4-06A MADOD0FX NG5U0	3.403,42
AN-08C4-08A	800	320-800	50 kA	29400233	AN-08C4-08A MADOD0FX NG5U0	3.403,42
AN-16C4-10A	1000	400-1000	50 kA	Sorunuz!	AN-16C4-10A MADOD0FX NG5U0	3.491,02
AN-16C4-13A	1250	500-1250	50 kA	Sorunuz!	AN-16C4-13A MADOD0FX NG5U0	3.491,02
AN-16C4-16A	1600	640-1600	50 kA	29400137	AN-16C4-16A MADOD0FX NG5U0	3.491,02
AH-08C4-06A	630	250-630	60 kA	Sorunuz!	AH-08C4-06A MADOD0FX NG5U0	3.531,97
AH-08C4-08A	800	320-800	60 kA	29410143	AH-08C4-08A MADOD0FX NG5U0	3.531,97
AH-16C4-10A	1000	400-1000	60 kA	Sorunuz!	AH-16C4-10A MADOD0FX NG5U0	4.641,20
AH-16C4-13A	1250	500-1250	60 kA	Sorunuz!	AH-16C4-13A MADOD0FX NG5U0	4.641,20
AH-16C4-16A	1600	640-1600	60 kA	29410144	AH-16C4-16A MADOD0FX NG5U0	4.641,20

Çekmece Ünitesi

Model	Berber Kullanılan Kasalar	Kutup	Sipariş Kodu	Açıklama	Liste Fiyatı (\$)
Susol Compact	AN/AH-08-C3 ≈ AN/AH-16-C3	3 kutup	52073471092	AL-H16C3 AHES	1.274,88
Susol Compact	AN/AH-08-C4 ≈ AN/AH-16-C4	4 kutup	52073471096	AL-H16C4 AHES	1.439,18

Açık Tip Şalterler

Yardımcı Donanımlar

Motor Mekanizmaları (M)

Model	Motor Çalışma Gerilimi	Berber Kullanılan Şalterler	Sipariş Kodu	Açıklama	Liste Fiyatı (\$)	
	M2	AC/DC 200~250V	SUSOL & METASOL	72313460504	MOTOR,AC/DC 200~250V,AN,AS,AH-DEFG,A/S	455,12
	M4	DC 24~30V		72313460505	MOTOR,DC 24~30V,AN,AS,AH-DEFG,A/S	455,12
	M6	AC 380V		72313460507	MOTOR,AC 380~415V,AN,AS,AH-DEFG,A/S	455,12
	M2	AC/DC 200~250V	SUSOL COMPACT	72313471151	MOTOR,AC/DC 200~250V, AN,AH-DEFG	396,70
	M4	DC 24~30V		72313471152	MOTOR,DC 24~30V,AN,AH-DEFG	396,70
	M6	AC 380V		72313471154	MOTOR,AC 380~415V,AN,AH-DEFG	396,70

Kapama Bobinleri (CC)

Model	Bobin Çalışma Gerilimi	Berber Kullanılan Şalterler	Sipariş Kodu	Açıklama	Liste Fiyatı (\$)	
	D4	DC24~30V	SUSOL & METASOL	77123460206	DC24~30V CC,UVSHCC	111,65
	D5 & D7	DC48~60V,AC48V		77123460207	DC48~60V,AC48V CC,UVSHCC	111,65
	D1 & D3	AC/DC 100~130V		77123460208	ADC100~130V CC,UVSHCC	111,65
	D2	AC/DC 200~250V	SUSOL COMPACT	77123460209	ADC200~250V CC,UVSHCC	111,65
	D6	AC380~480V		77123460210	AC380~480V CC,UVSHCC	111,65

Açtırma Bobinleri (SHT)

Model	Bobin Çalışma Gerilimi	Berber Kullanılan Şalterler	Sipariş Kodu	Açıklama	Liste Fiyatı (\$)	
	D4	DC24~30V	SUSOL & METASOL	77123460201	DC24~30V SHT,UVSHCC	92,68
	D5 & D7	DC48~60V,AC48V		77123460202	DC48~60V,AC48V SHT,UVSHCC	92,68
	D1 & D3	AC/DC 100~130V		77123460203	ADC100~130V SHT,UVSHCC	92,68
	D2	AC/DC 200~250V	SUSOL COMPACT	77123460204	ADC200~250V SHT,UVSHCC	92,68
	D6	AC/DC 380~480V		77123460205	AC380~480V SHT,UVSHCC	92,68

Düşük Gerilim Bobinleri (UVT)

Model	Bobin Çalışma Gerilimi	Berber Kullanılan Şalterler	Sipariş Kodu	Açıklama	Liste Fiyatı (\$)	
	U4	DC24~30V	SUSOL & METASOL	77123460231	DC24~30V UVT,UVSHCC	120,12
	U5 & U7	DC48~60V,AC48V		77123460232	DC48~60V,AC48V UVT,UVSHCC	120,12
	U1 & U3	AC/DC 100~130V		77123460233	ADC100~130V UVT,UVSHCC	120,12
	U2	AC/DC 200~250V	SUSOL COMPACT	77123460234	ADC200~250V UVT,UVSHCC	120,12
	U6	AC380~480V		77123460235	AC380~480V UVT,UVSHCC	120,12

Düşük Gerilim Bobini Geciktirme Ünitesi (UDC)

Model	Bobin Çalışma Gerilimi	Berber Kullanılan Şalterler	Sipariş Kodu	Açıklama	Liste Fiyatı (\$)	
	UDC	DC48~60V,AC48V	SUSOL & METASOL & SUSOL COMPACT	52773460271	UVT DELAY,DC48-60V,AC48V 0,5-3 sn gecikmeli	261,76
		ADC100~130V		52773460272	UVT DELAY,ADC100~130V 0,5-3 sn gecikmeli	261,76
		ADC200~250V		52773460273	UVT DELAY,ADC200~250V 0,5-3 sn gecikmeli	261,76
		AC380~480V		52773460274	UVT DELAY,AC380~480V 0,5-3 sn gecikmeli	261,76

Mekanik Kilitleme Modülü (MI)

Tanım	Model	Berber Kullanılan Şalterler	Sipariş Kodu	Açıklama	Liste Fiyatı (\$)	
	Mekanik Kilitleme Modülü	MI	Susol & Metasol	72313460791	Mekanik Kilitleme Modülü // 2WAY,AN,AS,AH-D,E,F,G,A/S	935,97
			Susol & Metasol	72313460510	Mekanik Kilitleme Modülü // 3WAY,AN,AS,AH-D,F,A/S	1.799,86
			Susol & Metasol	72313460512	Mekanik Kilitleme Modülü // 3WAY,AN,AS,AH-E,G,A/S	1.799,86
			Susol Compact	56123471500	Mekanik Kilitleme Modülü // 2WAY,AN,AH,AR-C	906,50
			Susol Compact	56123471505	Mekanik Kilitleme Modülü // 3WAY,AN,AH,AR-C	1.604,33
			Susol Compact	56123460502	Mekanik Kilitleme Kablosu // WIRE-2WAY*	791,88
			Susol Compact	56123460503	Mekanik Kilitleme Kablosu // WIRE-3WAY*	1.553,70

Yardımcı Kontak Blokları

Model	Tanım	Kontak	Berber Kullanılan Şalterler	Sipariş Kodu	Açıklama	Liste Fiyatı (\$)
AC	Yardımcı Kontak	3NO3NK	Susol & Metasol	72313461261	TOTAL ASS'Y,AUX SW,AC,3a3b,AN,AS,AH-D,F,AMP,CH	101,56
AX		3NO3NK	Susol & Metasol	72313461262	TOTAL ASS'Y,AUX SW,AX,3a3b,AN,AS,AH-D,F,AMP,CH	101,56
BC		5NO5NK	Susol & Metasol	72313461263	TOTAL ASS'Y,AUX SW,BC,5a5b,AN,AS,AH-D,F,AMP,CH	101,56
BX		5NO5NK	Susol & Metasol	72313461264	TOTAL ASS'Y,AUX SW,BX,5a5b,AN,AS,AH-D,F,AMP,CH	101,56
CC		6NO6NK	Susol & Metasol	72313461265	TOTAL ASS'Y,AUX SW,CC,6a6b,AN,AS,AH-D,F,AMP,CH	101,56
FX		4NO4NK	Susol Compact	72313471281	TOTAL ASS'Y,AUX SW,4C,AN,AH,AR-C	101,57

Yardımcı Donanımlar

Model	Susol & Metasol	Susol Compact	Sipariş Kodu	Açıklama	Liste Fiyatı (\$)
OT	√	√	72313460375	OCR Test Cihazı	2.823,54
ATS	√	√	05770000012	ATS Rölesi	5.189,10
AL	√		64273460254	Trip Alarm Kontakı + Manual Reset Butonu	132,38
K1	√		72313460553	Anahtarlı Kilit	158,56
		√	72313471611	Anahtarlı Kilit	177,01
B	√		72313460552	On/Off Buton Kilidi	92,68
		√	56773471612	On/Off Buton Kilidi	38,92
DF	√		64723460501	Kapı Çerçevesi, Çekmeceli şalter için	90,01
	√		64723460502	Kapı Çerçevesi, Sabit şalter için	90,01
DFC		√	64723471500	Kapı Çerçevesi, Sabit şalter için	90,01
		√	64723471501	Kapı Çerçevesi, Çekmeceli şalter için	90,01
DC	√		64623460501	IP54 Koruma Kapağı	806,17
		√	64623471402	IP54 Koruma Kapağı	767,78
C	√		72313460552	ON /OFF Sayıcı	92,68
		√	72313471551	ON /OFF Sayıcı	92,68
RCS	√		72313460558	Kapamaya Hazır Kontak	33,74
		√	72313471554	Kapamaya Hazır Kontak	33,72

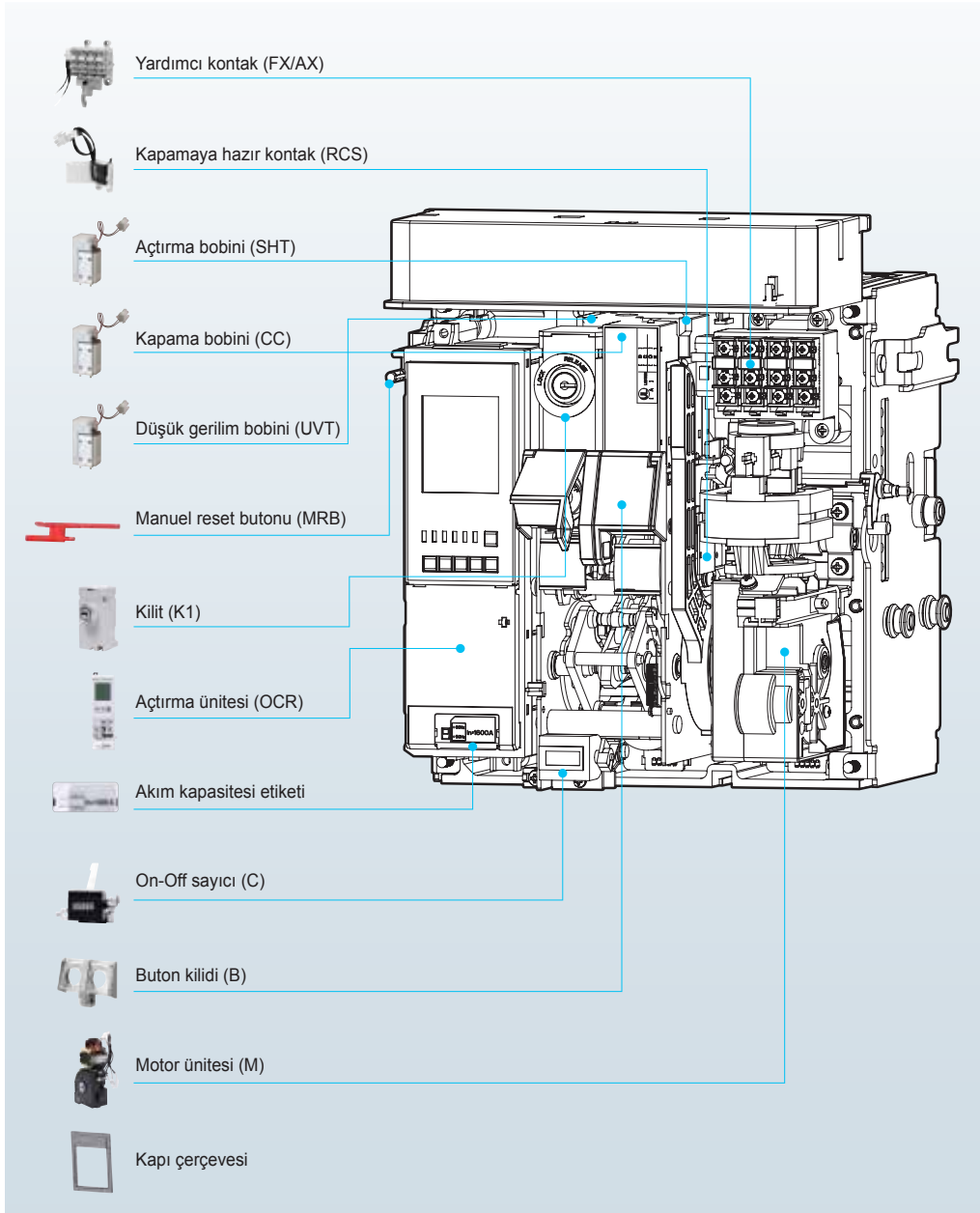

Optimum ürün çeşitliliği ile kusursuz müşteri memnuniyeti

Basit makina uygulamalarından büyük ölçekli proses kontrol uygulamalarına varan geniş ürün yelpazesi



Toplam Çözüm

Fan, Pompa, Komprasör,
Konveyör, Sarma Makinaları
ve Ekstrüder

Sektörel Uzmanlık

HVAC, Metal, Asansör,
Tekstil, Plastik, Enerji,
Marin, Gıda, Kağıt,
Maden, Su

Global Erişebilirlik

77 Ülkede Ulaşılabilirlik



“Teknik bilgi ve ürün seçimi için yetkili satış kanallarımız ile temasa geçebilirsiniz”

- ① General Drive G100 **new**
- ② Micro Drive M100 **new**
- ③ Standard Drive S100
- ④ Micro Drive iE5
- ⑤ Economical Drive iG5A
- ⑥ Fan/Pump-only Drive H100

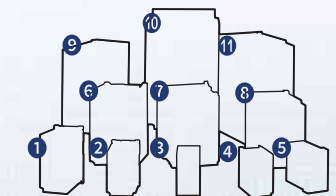

- ⑦ Standard Drive S100 (NEMA4X IP66)
- ⑧ Fan/Pump-only Drive H100
- ⑨ High-Performance Standard Drive iS7
- ⑩ Standard Drive S100
- ⑪ Vector Drive iV5